



VISHAY INTERTECHNOLOGY, INC.

# INTERACTIVE

## data book

---

### ZENER DIODES AND ESD PROTECTION COMPONENTS

VISHAY SEMICONDUCTORS

---

VHN-DB1103-0406

Notes:

1. To navigate:
  - a) Click on the Vishay logo on any datasheet to go to the Contents page for that section. Click on the Vishay logo on any Contents page to go to the main Table of Contents page.
  - b) Click on the products within the Table of Contents to go directly to the datasheet.
  - c) Use the scroll or page up/page down functions.
  - d) Use the Adobe® Acrobat® page function in the browser bar.
  
2. To search the text of the catalog use the Adobe® Acrobat® search function.



VISHAY INTERTECHNOLOGY, INC.

DATA BOOK

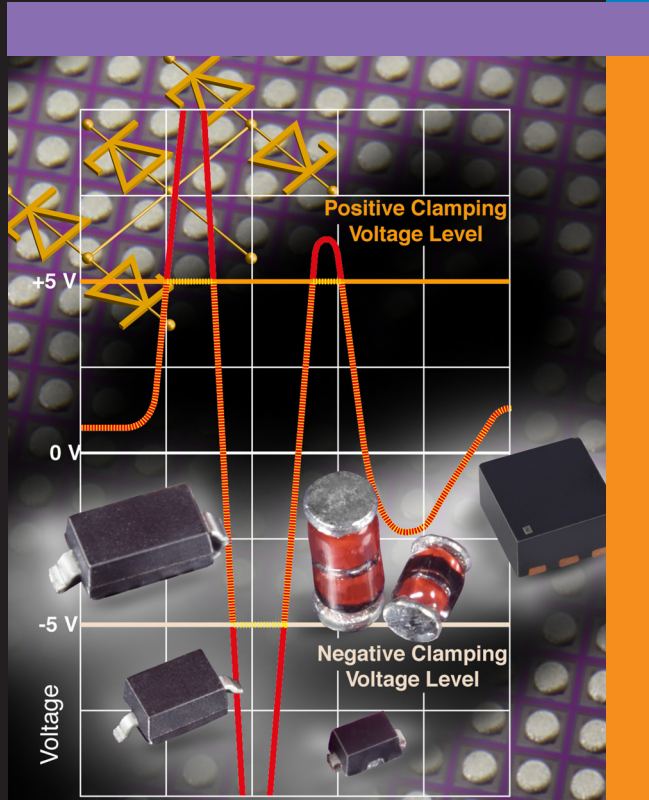

## Zener Diodes and ESD Protection Components

# VISHAY INTERTECHNOLOGY, INC.

<b>DISCRETE SEMICONDUCTORS</b>	<b>RECTIFIERS</b>	Schottky (single, dual) Standard, Fast and Ultra-Fast Recovery (single, dual) Clamper/Damper Bridge Superrectifier® Sinterglass Avalanche Diodes	
	<b>SMALL-SIGNAL DIODES</b>	Schottky and Switching (single, dual) Tuner/Capacitance (single, dual) Bandswitching PIN	
	<b>ZENER &amp; SUPPRESSOR DIODES</b>	Zener Diodes (single, dual) TVS (TransZorb®, Automotive, ESD, Arrays)	
	<b>MOSFETs</b>	Power MOSFETs JFETs	
	<b>RF TRANSISTORS</b>	Bipolar Transistors (AF and RF) Dual Gate MOSFETs MOSMICs®	
	<b>OPTOELECTRONICS</b>	IR Emitters, Detectors and IR Receiver Modules Opto Couplers and Solid State Relays Optical Sensors LEDs and 7 Segment Displays Infrared Data Transceiver Modules Custom products	
	<b>ICs</b>	Power ICs Analog Switches	
	<b>PASSIVE COMPONENTS</b>	<b>CAPACITORS</b>	Tantalum Capacitors Solid Tantalum Capacitors Wet Tantalum Capacitors Ceramic Capacitors Multilayer Chip Capacitors Disc Capacitors Film Capacitors Power Capacitors Heavy Current Capacitors Aluminum Capacitors Silicon RF Capacitors
		<b>RESISTIVE PRODUCTS</b>	Foil Resistors Film Resistors Thin Film Resistors Thick Film Resistors Metal Oxide Film Resistors Carbon Film Resistors Wirewound Resistors Variable Resistors Cermet Variable Resistors Wirewound Variable Resistors Conductive Plastic Variable Resistors Networks/Arrays Non-Linear Resistors NTC Thermistors PTC Thermistors Varistors
		<b>MAGNETICS</b>	Inductors Transformers
<b>INTEGRATED MODULES</b>	<b>DC/DC CONVERTERS</b>		
<b>STRAIN SENSORS AND TRANSDUCERS</b>	<b>STRAIN GAGES AND INSTRUMENTS</b>		
	<b>PHOTOSTRESS® INSTRUMENTS</b>		
	<b>TRANSDUCERS</b>	Load Cells Weighing Systems	

ONE OF THE WORLD'S LARGEST MANUFACTURERS OF DISCRETE SEMICONDUCTORS AND PASSIVE COMPONENTS

**Zener Diodes  
and  
ESD Protection Components  
Databook  
2004**

**Vishay Semiconductor GmbH  
P.O.B. 3535,  
D-74025 Heilbronn, Germany  
Telephone: 49 (0)7131 67 2831,  
Fax number: 49 (0)7131 67 2423  
Web: [www.vishay.com](http://www.vishay.com)**



Information contained in this paper is intended to provide a product description. Such description does not in any way constitute assured characteristics in the legal sense, nor do those design hints provide information regarding delivery conditions or availability.

Vishay Semiconductor GmbH makes no representation that the use or the interconnection of the circuits described herein will not infringe on existing or future patent rights, nor do the descriptions contained herein imply the granting of licenses to make, use or sell equipment constructed in accordance therewith.

The information presented in this paper is believed to be accurate and reliable. However, no responsibility is assumed by Vishay Semiconductor GmbH for its use.

Part of the publication may be reproduced without special permission on condition that author and source are quoted and that two copies of such extracts are placed at our disposal after publication. Written permission should be obtained from the publisher for complete reprints or translations. We reserve the right to amend any of the information without prior notice, including the issue of letters patent.

The products listed in this catalog are not generally recommended for use in life support systems where a failure or malfunction of the component may directly threaten life or cause injury.

The user of products in such applications assumes all risks of such use and will agree to hold Vishay Semiconductor GmbH and all the companies whose products are represented in this catalog, harmless against all damages.

All operating parameters including 'typicals' must be validated for each customer application by customer's technical experts.

Brand and product names used in this booklet are trademarks or registered trademarks of their respective holders.

© 2004 Copyright Vishay Intertechnology, Inc.

® Registered Trademarks of Vishay Intertechnology, Inc.

All rights reserved. Printed in (Germany)

Specifications subject to change without notice.

Please view latest data sheet editions under [www.vishay.com](http://www.vishay.com).



<b>Alphanumeric Index</b> .....	<b>5</b>
<b>Selector Guides</b> .....	<b>7</b>
<b>General Information</b> .....	<b>25</b>
Conventions Used in Presenting Technical Data.....	27
Assembly Instructions.....	29
Physical Explanation.....	33
Taping of Diodes.....	39
Quality Information.....	45
Reliability.....	53
The Constituents of Semiconductor Components.....	57
Marking of Diodes.....	73
<b>Zener Datasheets</b> .....	<b>77</b>
<b>ESD Datasheets</b> .....	<b>277</b>
<b>Packages</b> .....	<b>331</b>
<b>Application Notes</b> .....	<b>347</b>
Silicon Zener Diodes.....	349
Test and Measurement Methods on Zener Diodes.....	353
Temperature-Compensated Stabilizing Circuits.....	356
Pulse Power Rating of Semiconductors.....	359
<b>Glossary</b> .....	<b>361</b>
Symbols.....	363





## Numerics

---

1N4678 to 1N4717 .....	79
1N4728A to 1N4764A .....	83
1N5221B to 1N5267B .....	87
1N746A to 1N759A .....	93
1N957B to 1N984B .....	95

## A

---

AZ23-Series .....	97
-------------------	----

## B

---

BZD27C3V6P to BZD27C200P .....	105
BZG03C-Series .....	111
BZG04-Series .....	115
BZG05C-Series .....	119
BZM55-Series .....	123
BZT03-Series .....	129
BZT52-Series .....	133
BZT55-Series .....	141
BZW03-Series .....	147
BZX384-Series .....	173
BZX55-Series .....	151
BZX584C-02V Series .....	181
BZX84-Series .....	157
BZX85-Series .....	165

## D

---

DZ23-Series .....	183
-------------------	-----

## G

---

GCDA05 .....	279
GCDA15C-1 .....	281
GDZ-Series .....	191
GL05-HT3 to GL24-HT3 .....	283
GL05T to GL24T .....	285
GMDA05 .....	287
GMDA05-6 .....	289
GMDA05C .....	291
GMF05C .....	293

GMF05C - HS3 .....	295
GMF05LC .....	297
GMF05LC - HS3 .....	299
GMF05MC .....	301
GMF05MC - HS3 .....	305
GSOT03 to GSOT36 .....	309
GSOT03-HT3 to GSOT36-HT3 .....	311
GTF701-HS3 .....	315
GZF3V6C to GZF91C .....	193

## M

---

MMBZ...VDA and C Series .....	205
MMBZ4617 to MMBZ4627 .....	197
MMBZ4681 to MMBZ4717 .....	199
MMBZ5225 to MMBZ5267 .....	201
MMSZ4681 to MMSZ4717 .....	209
MMSZ5225 to MMSZ5267 .....	211

## P

---

Packages .....	333
----------------	-----

## S

---

Selector Guide ESD Protection .....	15
Selector Guide Zener Diodes .....	9
SMF5V0A to SMF51A .....	319
SML4728 to SML4764A .....	215

## T

---

TLZ-Series .....	219
TZM5221B to TZM5267B .....	225
TZM-Series .....	229
TZQ5221B to TZQ5267B .....	235
TZS4678 to TZS4717 .....	239
TZX-Series .....	243

## V

---

VESD05C-FC1 .....	323
VESDxx-02V .....	327



## Z

---

Z4KE100 to Z4KE200A .....	249
ZM4728A to ZM4764A .....	253
ZMU100 to ZMU180 .....	257
ZMY3V9 to ZMY100 .....	261
ZPU100 to ZPU180 .....	267
ZPY3V9 to ZPY110 .....	271

**Selector Guides**



General Information



Zener Datasheets



ESD Datasheets



Packages



Application Notes



Glossary





## Selector Guides

Zener Diodes (0.2 - 0.8 W)					
	Part Number	V <sub>Znom</sub>	V <sub>Z</sub> -Specification	Tolerance Groups	Page
		[V]		[%]	
<b>SOD-123, Single Diode</b>					
	BZT52B2V4 to BZT52B75	2.4 to 75	Pulse current	± 2%	133
	BZT52C2V4 to BZT52C75	2.4 to 75	Pulse current	± 5%	133
	MMSZ4681 to MMSZ4717	2.4 to 43	Thermal equilibrium	± 5%	209
	MMSZ5225C to MMSZ5267C	3 to 75	Thermal equilibrium	± 2%	211
	MMSZ5225B to MMSZ5267B	3 to 75	Thermal equilibrium	± 5%	211
<b>SOD-323, Single Diode</b>					
	BZX384B2V4 to BZX384B75	2.4 to 75	Pulse current	± 2%	173
	BZX384C2V4 to BZX384C75	2.4 to 75	Pulse current	± 5%	173
	GDZ2V0B to GDZ36B	2.0 to 36	Pulse current	± 2%	191
<b>SMF, Single Diode</b>					
	BZD27C3V6P to C200P	3.6 to 200	Pulse current	± 5%	105
	GZF3V6C to GZF91C	3.6 to 91	Pulse current	± 5%	193
<b>SOD-523, Single Diode</b>					
	BZX584C2V4-02V to BZX584C15-02V	2.4 to 15	Pulse current	± 5%	181
<b>SOT-23, Dual Common Anode</b>					
	AZ23B2V7 to AZ23B51	2.7 to 51	Pulse Current	± 2%	97
	AZ23C2V7 to AZ23C51	2.7 to 51	Pulse current	± 5%	97
<b>SOT-23, Dual Common Cathode</b>					
	DZ23B2V7 to DZ23B51	2.7 to 51	Pulse current	± 2%	183
	DZ23C2V7 to DZ23C51	2.7 to 51	Pulse current	± 5%	183
	MMBZ15VDA	15	Pulse current	± 2%	205
	MMBZ27VDA	27	Pulse current	± 2%	205
	MMBZ15VDC	15	Pulse current	± 5%	205
	MMBZ27VDC	27	Pulse current	± 5%	205







# Selector Guide Zener Diodes

Vishay Semiconductors





## Zener Diodes (0.2 - 0.8 W) (continued)

	Part Number	V <sub>Znom</sub>	V <sub>Z</sub> -Specification	Tolerance Groups	Page
		[V]		[%]	
<b>SOT-23, Single Diode</b>					
	BZX84B2V4 to BZX84B75	2.4 to 75	Pulse current	± 2%	157
	BZX84C2V4 to BZX84C75	2.4 to 75	Pulse current	± 2%	157
	MMBZ4617 to MMBZ4627	2.4 to 6.2	Pulse current	± 5%	197
	MMBZ4681 to MMBZ4717	2.4 to 43	Pulse current	± 5%	199
	MMBZ5225B to MMBZ5267B	3 to 75	Thermal equilibrium	± 5%	201
	MMBZ5225C to MMBZ5267C	3 to 75	Thermal equilibrium	± 2%	201
<b>MicroMELF, Single Diode</b>					
	BZM55B Series	2.4 to 75	Pulse current	± 2%	123
	BZM55C Series	2.4 to 75	Pulse current	± 5%	123
<b>MiniMELF SOD-80, Single Diode</b>					
	TLZ Series	2.4 to 56	Pulse current	Voltage Groups	219
	TZM5221B to TZM5267B	2.4 to 75	Thermal equilibrium	± 5%	225
	TZMB Series	2.4 to 75	Pulse current	± 2%	229
	TZMC Series	2.4 to 75	Pulse current	± 5%	229
<b>QuadroMELF SOD-80, Single Diode</b>					
	BZT55B Series	2.4 to 75	Pulse current	± 2%	141
	BZT55C Series	2.4 to 75	Pulse current	± 5%	141
	TZQ5221B to TZQ5267B	2.4 to 75	Thermal equilibrium	± 5%	235
	TZS4678 to TZS4717	1.8 to 43	Pulse current	± 5%	239
<b>DO-35, Single Diode</b>					
	1N4678 to 1N4717	1.8 to 43	Pulse current	± 5%	79
	1N5221B to 1N5267B	2.4 to 75	Thermal equilibrium	± 5%	87
	1N746A to 1N759A	3.3 to 12	Pulse current	± 5%	93
	1N957B to 1N984B	6.8 to 91	Thermal equilibrium	± 5%	95
	BZX55B Series	2.4 to 75	Pulse current	± 2%	151
	BZX55C Series	2.4 to 75	Pulse current	± 5%	151
	TZX Series	2.4 to 36	Pulse current	Voltage Groups	243

<sup>\*)</sup> Additional measurement of Voltage group 9V1 to 75 at 95 % V<sub>Zmin</sub> ≤ 35 nA at T<sub>J</sub> 25 °C

## Selector Guides

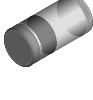
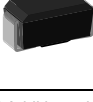
Zener Diodes (1.0 - 2.0 W)					
	Part Number	V <sub>Znom</sub>	V <sub>Z</sub> -Specification	Tolerance Groups	Page
		[V]			
<b>DO-41 Glass, Single Diode</b>					
	1N4728A to 1N4764A *	3.3 to 100	Thermal equilibrium	± 5%	83
	BZX85B Series	2.7 to 200	Pulse current	± 2%	165
	BZX85C Series	2.7 to 200	Pulse current	± 5%	165
	ZPU100 to ZPU180	100 to 180	Pulse current	± 10%	267
	ZPY3V9 to ZPY110	3.9 to 110	Pulse current	± 5%	271
<b>DO-41 Plastic, Single Diode</b>					
	Z4KE100A to Z4KE200A	100 to 200	Pulse current	± 5%	249
	Z4KE100 to Z4KE200	100 to 200	Pulse current	± 10%	249
<b>MELF Glass, Single Diode</b>					
	ZM4728A to ZM4764A	3.3 to 100	Thermal equilibrium	± 5%	253
	ZMU100 to ZMU180	100 to 180	Pulse current	± 10%	257
	ZMY3V9 to ZMY100	3.9 to 100	Pulse current	± 5%	261
<b>DO-214AC, Single Diode</b>					
	SML4728A to SML4764A	3.3 to 100	Pulse current	± 5%	215
	SML4728 to SML4764	3.3 to 100	Pulse current	± 10%	215

<sup>\*)</sup> Additional measurement of Voltage group 9V1 to 75 at 95 % V<sub>Zmin</sub> ≤ 35 nA at T<sub>j</sub> 25 °C

# Selector Guide Zener Diodes





Vishay Semiconductors

## Selector Guides

Zener Diodes (3 W)					
	Part Number	$V_{Znom}$	$V_Z$ -Specification	Tolerance Groups	Page
		[V]			
<b>DO-214AC, Single Diode</b>					
	BZG03C...	10 to 270	Pulse current	± 5%	111
	BZG05C...	3.3 to 100	Pulse current	± 5%	119

## Selector Guides

Zener Diodes (> 3W)					
	Part Number	V <sub>Znom</sub>	V <sub>Z</sub> -Specification	Tolerance Groups	Page
		[V]			
<b>SOD-57, Single Diode</b>					
	BZT03C...	6.2 to 270	Pulse current	± 5%	129
	BZT03D...	6.2 to 270	Pulse current	± 10%	129
<b>SOD-64, Single Diode</b>					
	BZW03C...	6.8 to 270	Pulse current	± 5%	147
	BZW03D...	6.8 to 270	Pulse current	± 10%	147
<b>DO-214AC, Single Diode</b>					
	BZG04...	8.2 to 220	Pulse current	± 5%	115

# Selector Guide Zener Diodes

---

Vishay Semiconductors

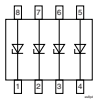
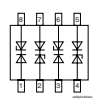
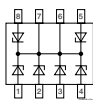
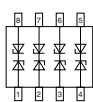

## Selector Guides

											
Part Number	V <sub>WM</sub>	V <sub>C</sub>	@I <sub>PP</sub> @tp=8/ 20µs	C <sub>J</sub> max	ESD Capability Air (1) min	ESD Capability contact (1) min	Pulse Peak Current (2) I <sub>PPM</sub> min	Bi- directional protected lines	Uni- directional protected lines	Page	
	[V]	[V]	[A]	[pF]	[kV]	[kV]	[A]				
<b>300 Watt (tp = 8/20 µs)</b>											
	GMDA05	5	9.8	1	400	15	8	17	2 lines	4 lines	287
	GCDA05	5	9.8	1	5	15	8	12	2 lines	4 lines	279
	GMDA05-6	5	9.8	1	400	15	8	12	5 lines	6 lines	289
	GMDA05C	5	9.8	1	400	15	8	17	4 lines	-	291

# Selector Guide ESD Protection

Vishay Semiconductors



## LLP75-6A Package ESD Protection Diodes and Arrays

Part Number	V <sub>WM</sub>	V <sub>C</sub>	@I <sub>PP</sub> @tp=8/ 20µs	C <sub>i</sub> max	ESD Capability Air (1) min	ESD Capability contact (1) min	Pulse Peak Current (2) I <sub>PPM</sub> min	Bi- directional protected lines	Uni- directional protected lines	Page
	[V]	[V]	[A]	[pF]	[kV]	[kV]	[A]			
<b>200 Watt (tp = 8/20 µs)</b>										
 GMF05C-HS3	5	12.5	12	150	15	8	12	4 lines	5 lines	295



## LLP75-6A Package ESD Protection Diodes and Arrays

Part Number	V <sub>WM</sub>	V <sub>C</sub>	@I <sub>PP</sub> @tp=8/ 20µs	C <sub>i</sub> max	ESD Capability Air (1) min	ESD Capability contact (1) min	Pulse Peak Current (2) I <sub>PPM</sub> min	Bi- directional protected lines	Uni- directional protected lines	Page
	[V]	[V]	[A]	[pF]	[kV]	[kV]	[A]			
<b>100 Watt (tp = 8/20 µs)</b>										
 GMF05MC-HS3	5	12	7	75	15	8	7	4 lines	5 lines	305





## LLP75-6A Package ESD Protection Diodes and Arrays

Part Number	V <sub>WM</sub>	V <sub>C</sub>	@I <sub>PP</sub> @tp=8/ 20μs	C <sub>J</sub> max	ESD Capability Air (1) min	ESD Capability contact (1) min	Pulse Peak Current (2) I <sub>PPM</sub> min	Bi- directional protected lines	Uni- directional protected lines	Page
	[V]	[V]	[A]	[pF]	[kV]	[kV]	[A]			
<b>70 Watt (tp = 8/20 μs)</b>										
 GMF05LC-HS3	5	12.5	5	50	15	8	5	4 lines	5 lines	299



## LLP75-3B Package ESD Protection Diodes and Arrays

Part Number	V <sub>WM</sub>	V <sub>C</sub>	@I <sub>PP</sub> @tp=8/ 20μs	C <sub>J</sub> max	ESD Capability Air (1) min	ESD Capability contact (1) min	Pulse Peak Current (2) I <sub>PPM</sub> min	Bi- directional protected lines	Uni- directional protected lines	Page	
	[V]	[V]	[A]	[pF]	[kV]	[kV]	[A]				
<b>300 Watt (tp = 8/20 μs)</b>											
	GSOT03-HT3	3.3	6.5	1	800	15	8	18	-	1 line	311
	GSOT04-HT3	4	8.5	1	800	15	8	17	-	1 line	311
	GSOT05-HT3	5	9.8	1	550	15	8	17			311
	GSOT08-HT3	8	13.4	1	400	15	8	15			311
	GSOT12-HT3	12	19	1	185	15	8	12			311
	GSOT15-HT3	15	24	1	140	15	8	10			311
	GSOT24-HT3	24	43	1	83	15	8	5			311
	GSOT36-HT3	36	60	1	80	15	8	2			311
	GL05-HT3	5	11	17	5	15	8		-	1 line	283
	GL12-HT3	12	24	12	5	15	8				283
	GL15-HT3	15	33	10	5	15	8				283
	GL24-HT3	24	55	5	5	15	8				283



# Selector Guide ESD Protection

Vishay Semiconductors



## SOT-23 Package ESD Protection Diodes and Arrays

Part Number	V <sub>WM</sub>	V <sub>C</sub>	@ I <sub>PP</sub> @ tp=8/ 20μs	C <sub>j</sub> max	ESD Capability Air (1) min	ESD Capability contact (1) min	Pulse Peak Current (2) I <sub>PPM</sub> min	Bi- directional protected lines	Uni- directional protected lines	Page	
	[V]	[V]	[A]	[pF]	[kV]	[kV]	[A]				
<b>300 Watt (tp = 8/20 μs)</b>											
	GSOT03	3.3	6.5	1	800	15	8	18	-	1 line	309
	GSOT04	4	8.5	1	600	15	8	17	-	1 line	309
	GSOT05	5	9.8	1	550	15	8	17	-	1 line	309
	GSOT08	8	13.4	1	400	15	8	15	-	1 line	309
	GSOT12	12	19	1	185	15	8	12	-	1 line	309
	GSOT15	15	24	1	140	15	8	10	-	1 line	309
	GSOT24	24	43	1	83	15	8	5	-	1 line	309
GSOT36	36	60	1	80	15	8	2	-	1 line	309	
	GL05T	5	9.8	1	5	15	8	17	-	1 line	285
	GL12T	12	19	1	5	15	8	12	-	1 line	285
	GL15T	15	24	1	5	15	8	10	-	1 line	285
	GL24T	24	43	1	5	15	8	5	-	1 line	285



## SOT-143 Package ESD Protection Diodes and Arrays

Part Number	V <sub>WM</sub>	V <sub>C</sub>	@ I <sub>PP</sub> @ tp=8/ 20μs	C <sub>j</sub> max	ESD Capability Air (1) min	ESD Capability contact (1) min	Pulse Peak Current (2) I <sub>PPM</sub> min	Bi- directional protected lines	Uni- directional protected lines	Page	
	[V]	[V]	[A]	[pF]	[kV]	[kV]	[A]				
<b>350 Watt (tp = 8/20 μs)</b>											
	GCDA15C-1	15	35	10	5	15	8	10	1 line	-	281



## SOT-363 Package ESD Protection Diodes and Arrays

Part Number	V <sub>WM</sub>	V <sub>C</sub>	@I <sub>PP</sub> @tp=8/ 20μs	C <sub>J</sub> max	ESD Capability Air (1) min	ESD Capability contact (1) min	Pulse Peak Current (2) I <sub>PPM</sub> min	Bi- directional protected lines	Uni- directional protected lines	Page
	[V]	[V]	[A]	[pF]	[kV]	[kV]	[A]			
<b>200 Watt (tp = 8/20 μs)</b>										
 GMF05C	5	12.5	12	150	15	8	12	4 lines	5 lines	293



## SOT-363 Package ESD Protection Diodes and Arrays

Part Number	V <sub>WM</sub>	V <sub>C</sub>	@I <sub>PP</sub> @tp=8/ 20μs	C <sub>J</sub> max	ESD Capability Air (1) min	ESD Capability contact (1) min	Pulse Peak Current (2) I <sub>PPM</sub> min	Bi- directional protected lines	Uni- directional protected lines	Page
	[V]	[V]	[A]	[pF]	[kV]	[kV]	[A]			
<b>100 Watt (tp = 8/20 μs)</b>										
 GMF05MC	5	12	7	75	15	8	7	4 lines	5 lines	301

# Selector Guide ESD Protection

Vishay Semiconductors



## SOT-363 Package ESD Protection Diodes and Arrays

Part Number	V <sub>WM</sub>	V <sub>C</sub>	@ I <sub>PP</sub> @ tp=8/ 20μs	C <sub>j</sub> max	ESD Capability Air (1) min	ESD Capability contact (1) min	Pulse Peak Current (2) I <sub>PPM</sub> min	Bi- directional protected lines	Uni- directional protected lines	Page
	[V]	[V]	[A]	[pF]	[kV]	[kV]	[A]			
<b>70 Watt (tp = 8/20 μs)</b>										
 GMF05LC	5	12.5	5	50	15	8	5	4 lines	5 lines	297



## SMF Package ESD Protection Diodes and Arrays

	Part Number	V <sub>WM</sub>	V <sub>C</sub>	@I <sub>PP</sub> @tp=8/ 20μs	C <sub>J</sub> max	ESD Capability Air (1) min	ESD Capability contact (1) min	Pulse Peak Current (2) I <sub>PPM</sub> min	Bi- directional protected lines	Uni- directional protected lines	Page
		[V]	[V]	[A]	[pF]	[kV]	[kV]	[A]			
<b>1000 Watt (tp = 8/20 μs)</b>											
	SMF5V0A	5	9.2	21.7 (10/ 1000μs)	103 0	15	8	21.7	-	1 line	319
	SMF6V0A	6	10.3	19.4 (10/ 1000μs)	101 0	15	8	19.4	-	1 line	319
	SMF6V5A	6.5	11.2	17.9 (10/ 1000μs)	850	15	8	17.9	-	1 line	319
	SMF7V0A	7	12	16.7 (10/ 1000μs)	750	15	8	16.7	-	1 line	319
	SMF7V5A	7.5	12.9	15.5 (10/ 1000μs)	730	15	8	15.5	-	1 line	319
	SMF8V0A	8	13.6	14.7 (10/ 1000μs)	670	15	8	14.7	-	1 line	319
	SMF8V5A	8.5	14.4	13.9 (10/ 1000μs)	660	15	8	13.9	-	1 line	319
	SMF9V0A	9	15.4	13.5 (10/ 1000μs)	620	15	8	13.5	-	1 line	319
	SMF10A	10	17	11.8 (10/ 1000μs)	570	15	8	11.8	-	1 line	319
	SMF11A	11	18.2	11 (10/ 1000μs)	460	15	8	11	-	1 line	319
	SMF12A	12	19.9	10.1 (10/ 1000μs)	440	15	8	10.1	-	1 line	319
	SMF13A	13	21.5	9.3 (10/ 1000μs)	420	15	8	9.3	-	1 line	319
	SMF14A	14	23.2	8.6 (10/ 1000μs)	370	15	8	8.6	-	1 line	319
	SMF15A	15	24.4	8.2 (10/ 1000μs)	350	15	8	8.2	-	1 line	319
	SMF16A	16	26	7.7 (10/ 1000μs)	340	15	8	7.7	-	1 line	319
	SMF17A	17	27.6	7.2 (10/ 1000μs)	310	15	8	7.2	-	1 line	319
SMF18A	18	29.2	5.8 (10/ 1000μs)	305	15	8	5.8	-	1 line	319	
SMF20A	20	32.4	6.2 (10/ 1000μs)	207	15	8	6.2	-	1 line	319	
SMF22A	22	35.5	5.6 (10/ 1000μs)	265	15	8	5.6	-	1 line	319	
SMF24A	24	38.9	5.1 (10/ 1000μs)	240	15	8	5.1	-	1 line	319	

# Selector Guide ESD Protection

Vishay Semiconductors



## SMF Package (continued) ESD Protection Diodes and Arrays

	Part Number	V <sub>WM</sub>	V <sub>C</sub>	@I <sub>PP</sub> @tp=8/ 20μs	C <sub>j</sub> max	ESD Capability Air (1) min	ESD Capability contact (1) min	Pulse Peak Current (2) I <sub>PPM</sub> min	Bi- directional protected lines	Uni- directional protected lines	Page
		[V]	[V]	[A]	[pF]	[kV]	[kV]	[A]			
	SMF26A	26	42.1	4.8 (10/ 1000μs)	225	15	8	4.8	-	1 line	319
	SMF28A	28	45.4	4.4 (10/ 1000μs)	210	15	8	4.4	-	1 line	319
	SMF30A	30	48.4	4.1 (10/ 1000μs)	205	15	8	4.1	-	1 line	319
	SMF33A	33	53.3	3.8 (10/ 1000μs)	190	15	8	3.8	-	1 line	319
	SMF36A	36	58.1	3.4 (10/ 1000μs)	180	15	8	3.4	-	1 line	319
	SMF40A	40	64.5	3.1 (10/ 1000μs)	165	15	8	3.1	-	1 line	319
	SMF43A	43	69.4	2.9 (10/ 1000μs)	160	15	8	2.9	-	1 line	319
	SMF45A	45	72.7	2.8 (10/ 1000μs)	155	15	8	2.8	-	1 line	319
	SMF48A	48	77.4	2.6 (10/ 1000μs)	150	15	8	2.6	-	1 line	319
	SMF51A	51	82.4	2.4 (10/ 1000μs)	145	15	8	2.4	-	1 line	319





## Flipchip 1005 Package ESD Protection Diodes and Arrays

	Part Number	V <sub>WM</sub>	V <sub>C</sub>	@I <sub>PP</sub> @tp=8/ 20μs	C <sub>j</sub> max	ESD Capability Air (1) min	ESD Capability contact (1) min	Pulse Peak Current (2) I <sub>PPM</sub> min	Bi- directional protected lines	Uni- directional protected lines	Page
		[V]	[V]	[A]	[pF]	[kV]	[kV]	[A]			
<b>120 Watt (tp = 8/20 μs)</b>											
	VESD05C-FC1	5	9/11	1/10	70	30	8	10			323

(1) (IEC61000-4-2)

(2) (IEC61000-4-5)

## Selector Guides

											
Part Number	V <sub>WM</sub>	V <sub>C</sub>	@I <sub>PP</sub> @tp=8/ 20μs	C <sub>J</sub> max	ESD Capability Air (1) min	ESD Capability contact (1) min	Pulse Peak Current (2) I <sub>PPM</sub> min	I <sub>R</sub>	@V <sub>R</sub>	Page	
	[V]	[V]	[A]	[pF]	[kV]	[kV]	[A]	[μA]	[V]		
<b>70 Watt (tp = 8/20 μs)</b>											
	GTF701-HS3	5	15	4	120	15	8	4	1	5	315

# Selector Guide ESD Protection

---

Vishay Semiconductors



Selector Guides



**General Information**



Zener Datasheets



ESD Datasheets



Packages



Application Notes



Glossary







## Conventions Used in Presenting Technical Data

### Nomenclature for Semiconductor Devices According to Pro Electron

The part number of a semiconductor device consists

of two letters followed by a serial number.

For example:

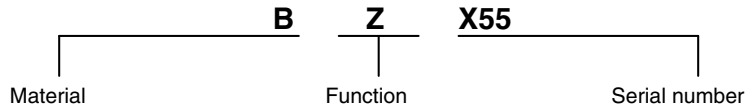

18651

The **first letter** indicates the material used for the active part of the device.

<p>A GERMANIUM (Materials with a bandgap 0.6 –1.0 eV) <sup>1)</sup></p> <p>B SILICON (Materials with a bandgap 1.0 –1.3 eV) <sup>1)</sup></p> <p>C GALLIUM-ARSENIDE (Materials with a bandgap &gt; 1.3 eV) <sup>1)</sup></p> <p>R COMPOUND MATERIALS (For example Cadmium-Sulfide)</p>	<p>M</p> <p>N</p> <p>P</p> <p>Q</p> <p>R</p> <p>S</p> <p>T</p> <p>U</p> <p>X</p>
--	--

HALL EFFECT DEVICE:

in a closed magnetic circuit

PHOTO COUPLER

DIODE: radiation sensitive

DIODE: radiation generating

THYRISTOR: low power

TRANSISTOR: low power, switching

THYRISTOR: power

TRANSISTOR: power, switching

DIODE:

multiplier, e.g., Varicap, step recovery

DIODE: rectifying, booster

DIODE: voltage reference or voltage

regulator, transient suppressor diode

The **second letter** indicates the circuit function.

<p>A</p> <p>B</p> <p>C</p> <p>D</p> <p>E</p> <p>F</p> <p>G</p> <p>H</p> <p>K</p> <p>L</p>	<p>DIODE: detection, switching or mixer</p> <p>DIODE: variable capacitance</p> <p>TRANSISTOR: low power, audio frequency</p> <p>TRANSISTOR: power, audio frequency</p> <p>DIODE: tunnel</p> <p>TRANSISTOR: low power, high frequency</p> <p>DIODE: oscillator and miscellaneous</p> <p>DIODE: magnetic sensitive</p> <p>HALL EFFECT DEVICE: in an open magnetic circuit</p> <p>TRANSISTOR: power, high frequency</p>
---	--

The **serial number** consists of:

- A four digit number from 100 to 9999 for devices primarily intended for consumer equipment.
- One letter (Z, Y, X, etc.) and a three-digit number from 10 to 999 for devices primarily intended for professional equipment.

A version letter can be used to indicate a deviation of a single characteristic, either electrical or mechanical.

This letter does not have a fixed meaning. The only exception is the use of the letter R, indicating reversed voltage (e.g., collector to case).

<sup>1)</sup> The materials mentioned are examples

## Polarity Conventions

The voltage direction is given

- by an arrow which points out from the measuring point to the reference point or
- by a two letter subscript, where the first letter is the measuring point and the second letter is the reference point.

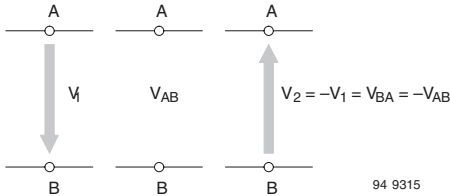

Figure 1.

The numerical value of the voltage is positive if the potential at the arrow tail is higher than at the arrow head; i.e., the potential difference from the measuring point (A) to the reference point (B) is positive.

The numerical value of the voltage is negative if the potential at the arrow head is higher than the tail; i.e., the potential difference from the measuring point to the reference point is negative.

In the case of alternating voltages, once the voltage direction is selected, it is maintained throughout. The alternating character of the quantity is given with the time dependent change in sign of its numerical values.



94 9316

Figure 2.

The numerical value of the current is positive if the charge of the carriers moving in the direction of the arrow is positive (conventional current direction), or if the charge of the carriers moving against this direction is negative. The numerical value of the current is negative, if the charge of the carriers moving in the direction of the arrow is negative, or if the charge of the carriers moving against this direction is positive.

The general rules stated above are also valid for alternating quantities. Once the direction is selected, it is maintained throughout. The alternating character of the quantity is given with the time-dependent change in sign of its numerical values.

## Polarity conventions for diodes

Here, the direction of arrows is selected in such a way that the numerical values of currents and voltages are positive both for forward (F or f) and reverse (R or r) directions.

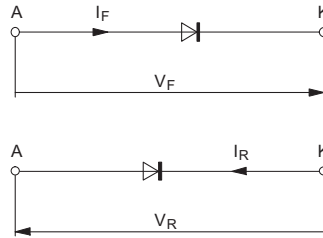

94 9317

Figure 3.

# Assembly Instructions

## General

Semiconductor devices can be mounted in any position. The terminal length may be bent at a distance greater than 1.5 mm from the case provided no mechanical force has an effect on the case.

If the device is to be mounted near heat generating components, consideration must be given to the resultant increase in ambient temperature.

## Soldering Instructions

### Leaded Devices

Protection against overheating is essential when a device is being soldered. It is recommended, therefore, that connection terminals are left as long as possible,

are soldered at the tip only, and that any heat generated is quickly conducted away. The time during which the specified maximum permissible device junction temperature is exceeded during the soldering operation should be as short as possible, (i.e., for silicon, 260 °C for 5 seconds.

Avoid any force on the body or leads during or just after soldering.

Do not correct the position of an already soldered device by pushing, pulling or twisting the body. Prevent fast cooling after soldering.

The maximum soldering temperatures are shown in table 1.

	Iron Soldering			Dip or Flow Soldering			
	Iron Temperature	Soldering Distance from the Case	Maximum Allowable Soldering Time	Soldering Temperature	Soldering Distance from the Case		Maximum Allowable Soldering Time
					Vertical	Horizontal	
Glass case	≤ 260 °C	1.5 to 5 mm	5 s	≤ 260 °C	> 1.5 mm	> 5 mm	5 s
	≤ 260 °C	> 5 mm	10 s				
	260 to 400 °C	> 5 mm	5 s				
Plastic case	≤ 260 °C	2 to 5 mm	3 s	≤ 260 °C	> 1.5 mm	> 5 mm	3 s
	≤ 260 °C	> 5 mm	5 s				
23 A 3 DIN41869 (SOT23)	≤ 250 °C	–	10 s	≤ 250 °C	–	–	10 s

Table 1: Maximum soldering temperatures

### Surface Mounted Devices

Surface mounted devices (SMD) are components which are mounted directly on the surface of a printed circuit board without having to drill holes. In addition, these components can be completely submerged in solder bath (overhead soldering). The SMD technology offers the following main advantages:

- Higher packing density (miniaturization)
- Reduction of the component mounting costs fully automatic mounting

#### a) Gluing

In the case of flow or drag soldering, the components must be glued to the printed circuit board. The adhesive used for this purpose must be electrically neutral and must not react chemically with the materials of the printed circuit board or the components. The adhesive must not negatively affect subsequent soldering. After mounting, the adhesive must be hardened. The ultraviolet and/or thermal radiation commonly used for hardening is uncritical for our

components. In the case of other soldering methods, gluing can be omitted if the flux or the solder paste provides sufficient adhesion of the components to the printed circuit board.

#### b) Soldering

The pins of Vishay components are already tinned. Dip soldering, flow soldering, reflow soldering, and vapor phase soldering are permissible.

The maximum temperature of 260 °C over a period 5 s must not be exceeded during soldering.

No aggressive fluxes may be used.

A soldering iron should be used only in exceptional cases (repairs, etc.). A temperature regulated miniature soldering iron must be used, and care should be taken to avoid touching the component with the tip of the soldering iron.

For optoelectronic semiconductor components, the maximum soldering temperature is 240 °C for 5 s.

## Vishay Semiconductors

### c) Cooling

Cooling of the components with a fan after soldering is permissible.

### d) Cleaning

If cleaning is necessary after soldering, it is recommended to wash with water which contains a detergent free of deposits.

### Important layout notes

If components are to be arranged in rows, then separate soldering surfaces must be provided for each component. If this is not carried out, a block of solder forms between the components during soldering, and a rigid connection result. This can cause breakage or cracks in the component as the result of the slightest bending of the board, and thus lead to failures. If it is necessary to solder a wire (standard conductor, etc.) to the board, a separate soldering surface must be provided in order to avoid excessive heating of the components during soldering with a soldering iron.

### Heat Removal

To keep the thermal equilibrium, the heat generated in the semiconductor junction(s) must be removed. In the case of low-power devices, the natural heat conductive path between the case and surrounding air is usually adequate for this purpose. However, in the case of medium-power devices, heat radiation may have to be improved by the use of star- or flag-shaped heat dissipaters, which increase the heat radiating surface.

Finally, in the case of high-power devices, special heat sinks must be provided, the cooling effect of which can be increased further by the use of special coolants or air blowers.

The heat generated in the junction is conveyed to the case or header by conduction rather than convection. A measure of the effectiveness of heat conduction is the inner thermal resistance or thermal resistance junction case,  $R_{thJC}$ , the value of which is governed by the construction of the device.

Any heat transfer from the case to the surrounding air involves radiation convection and conduction. The effectiveness of transfer is expressed in terms of an  $R_{thCA}$ -value, i.e., the external or case-ambient thermal resistance. The total thermal resistance between junction and ambient is consequently

$$R_{thJA} = R_{thJC} + R_{thCA}$$

The total maximum power,  $P_{tot\ max}$ , of a semiconductor device can be expressed as follows

$$P_{tot\ max} = \frac{T_{jmax} - T_{amb}}{R_{thJA}} = \frac{T_{max} - T_{amb}}{R_{thJA} + R_{thCA}}$$

where

$T_{jmax}$  is the maximum junction temperature,  
 $T_{amb}$  is the highest ambient temperature likely to be reached under the most unfavorable conditions,

$R_{thJA}$  is the thermal resistance between junction and ambient. For diodes with axial leads, it is measured with a heat sink at a specified distance from the case,

$R_{thJC}$  is the thermal resistance between junction and case,

$R_{thCA}$  is the thermal resistance between case and ambient.

Its value is cooling dependent. When using a heat sink, it can be influenced through thermal contact between the case and heat sink, thermal distribution in the heat sink and heat transfer to the surroundings. Therefore, the maximum permissible total power dissipation for a given semiconductor device can be influenced only by changing  $T_{amb}$  and  $R_{thCA}$ . The value of  $R_{thCA}$  can be obtained either from the data of heat sink suppliers or through direct measurements.

Heat due to energy losses is mainly conducted with power diodes without cooling pins through the connecting leads and hence the pc board.

Figure 1 shows the thermal resistance plotted as a function of edge length. The values are valid with a heat source in the middle of the plate, resting air and vertical position. With horizontal position, thermal resistance increases approximately by 15 to 20 %.

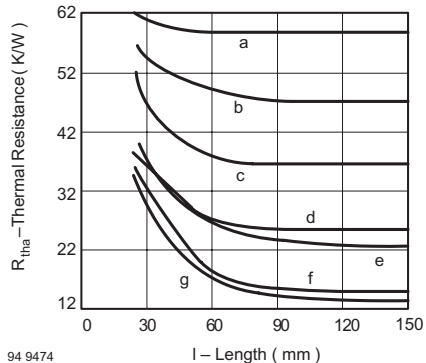

Figure 1.

Pertinax boards 1.5 mm thick

- a: Pertinax non-metallized
- b: Pertinax with 35 mm copper metallization on one side; heat source fitted to non-metallized side
- c: Pertinax with 70 mm copper metallization on one side; heat source fitted to non-metallized side
- d: Pertinax with 35 mm copper metallization on one side; heat source fitted to metallized side
- e: Pertinax with 35 mm copper metallization on both sides
- f: Pertinax with 70 mm copper metallization on one side; heat source fitted to metallized side
- g: Pertinax with 70 mm copper metallization on both sides

$R_{thCA}$ : Thermal resistance of boards

l: Edge length

When using cooling plates as heat sinks without optimum performance, the following approach is acceptable.

The curves shown in figures 2 and 3 are given for thermal resistance,  $R_{thCA}$ , by using square plates of aluminium with edge length  $a$  but with different thicknesses.

The device case should be mounted directly on the cooling plate.

The edge length  $a$  derived from figures 2 and 3 for a given  $R_{thCA}$  value must be multiplied with  $\alpha$  and  $\beta$ :

$$a' = a \times \beta \times \alpha$$

where

$\alpha = 1.00$  for vertical arrangement

$\alpha = 1.15$  for horizontal arrangement

$\beta = 1.00$  for bright surface

$\beta = 0.85$  for dull black surface

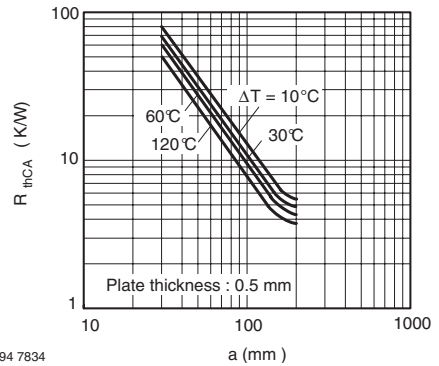

Figure 2.

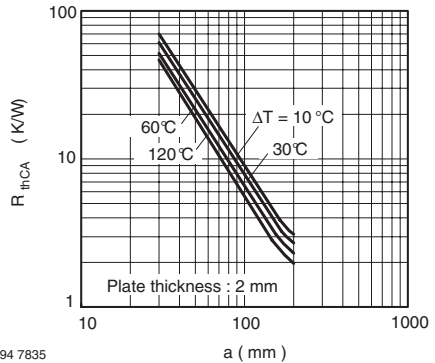

Figure 3.



## Physical Explanation

### General Terminology

Semiconductor diodes are used as rectifiers, switchers, Varicaps and voltage stabilizers (see chapter 'Voltage Regulator and Z-diodes').

Semiconductor diodes are two-terminal solid-state devices having asymmetrical voltage-current characteristics. Unless otherwise stated, this means a device has single pn-junction corresponding to the characteristics shown in figure 1.

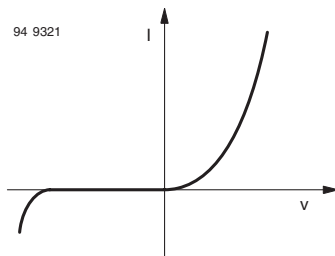

Figure 1.

An application of the voltage current curve is given by

$$I = I_S \left( \exp \frac{V}{V_T} - 1 \right)$$

where

$I_S$  = saturation current

$$V_T = \frac{k \times T}{q} = \text{temperature potential}$$

If the diode is forward-biased (anode positive with respect to cathode), its forward current ( $I = I_F$ ) increases rapidly with increasing voltage. That is, its resistance becomes very low.

If the diode is reverse-biased (anode negative with respect to cathode), its reverse current ( $-I = I_R$ ) is extremely low. This is only valid until the breakdown voltage  $V_{(BR)}$  has been reached. When the reverse voltage is slightly higher than the breakdown voltage, a sharp rise in reverse current results.

### Bulk resistance

Resistance of the bulk material between junction and the diode terminals.

### Parallel resistance, $r_p$

Diode resistance resulting from HF rectification which acts as a damping resistance to the pre-tuned demodulation circuit.

### Diode capacitance, $C_D$

Total capacitance between the diode terminals due to case, junction and parasitic capacitances.

### Breakdown voltage, $V_{(BR)}$

Reverse voltage at which a small increase in voltage results in a sharp rise of reverse current. It is given in the technical data sheet for a specified current.

### Forward voltage, $V_F$

The voltage across the diode terminals which results from the flow of current in the forward direction.

### Forward current, $I_F$

The current flowing through the diode in the direction of lower resistance.

### Forward resistance, $r_F$

The quotient of dc forward voltage across the diode and the corresponding dc forward current.

### Forward resistance, differential $r_f$

The differential resistance measured between the terminals of a diode under specified conditions of measurement, i.e., for small-signal ac voltages or currents at a point of forward direction V-I characteristic.

### Case capacitance, $C_{case}$

Capacitance of a case without a semiconductor crystal.

### Integration time, $t_{av}$

With certain limitations, absolute maximum ratings given in technical data sheets may be exceeded for a short time. The mean value of current or voltage is decisive over a specified time interval termed integration time. These mean values over time interval,  $t_{av}$ , should not exceed the absolute maximum ratings.

### Average rectified output current, $I_{FAV}$

The average value of the forward current when using the diode as a rectifier. The maximum allowable average rectified output current depends on the peak value of the applied reverse voltage during the time interval at which no current is flowing. In the absolute maximum ratings, one or both of the following are given:

- The maximum permissible average rectified output current for zero diode voltage (reverse)



## Vishay Semiconductors

- The maximum permissible average rectified output current for the maximum value of  $U_{RRM}$  during the time interval at which no current is flowing.

**Note:**  $I_{FAV}$  decreases with an increasing value of the reverse voltage during the interval of no current flow.

### Rectification efficiency, $\eta_r$

The ratio of the dc load voltage to the peak input voltage of an RF rectifier.

### Reverse recovery time, $t_{rr}$

The time required for the current to reach a specified reverse current,  $i_R$ , after instantaneous switching from a specified forward condition ( $I_F$ ) to a specified reverse bias condition ( $I_R$ ).

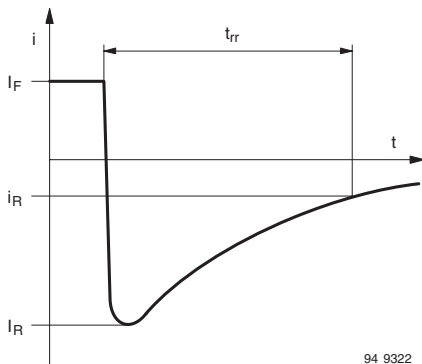

Figure 2.

### Series resistance, $r_s$

The total value of resistance representing the bulk, contact and lead resistance of a diode given in the equivalent circuit diagram of variable Varicaps.

### Junction capacitance, $C_j$

Capacitance due to a pn junction of a diode which decreases with increasing reverse voltage.

### Reverse voltage, $V_R$

The voltage drop which results from the flow of reverse current (through the semiconductor diode).

### Reverse current, $I_R$ (leakage current)

The current which flows when reverse bias is applied to a semiconductor junction.

### Reverse resistance, $R_R$

The quotient of the dc reverse voltage across a diode and the corresponding dc reverse current.

### Reverse resistance, differential, $r_r$

The differential resistance measured between the terminals of a diode under specified condition of measurement i.e., for small-signal (ac) voltage or currents at a point of reverse-voltage direction V-I characteristic.

### Peak forward current, $I_{FRM}$

The maximum forward current with sine-wave operation,  $f \geq 25$  Hz, or pulse operation,  $f \geq 25$  Hz, having a duty cycle  $t_p/T \leq 0.5$ .

### Peak reverse voltage, $V_{RRM}$

The maximum reverse voltage having an operating frequency  $f \geq 25$  Hz for sine-wave as well as pulse operation.

### Peak surge forward current, $I_{FSM}$

The maximum permissible surge current in a forward direction having a specified waveform with a short specified time interval (10 ms) unless otherwise specified. It is not an operating value. During frequent repetitions, there is a possibility of change in the device's characteristic.

### Peak surge reverse voltage, $V_{RSM}$

The maximum permissible surge voltage applied in a reverse direction. It is not an operating value. During frequent repetitions, there is a possibility of change in the device's characteristic.

### Power dissipation, $P_v$

An electrical power converted into heat. Unless otherwise specified, this value is given in the data sheets under absolute maximum ratings, with  $T_{amb} = 25$  °C at a specified distance from the case (both ends).

### Forward recovery time, $t_{fr}$

The time required for the voltage to reach a specified value after instantaneous switching from zero or a specified reverse voltage to a specified forward biased condition.

This recovery time is especially noticeable when higher currents are to be switched within a short time. The reason is that the forward resistance during the turn-on time could be higher than the dc current (inductive behavior). This can result in the destruction of a diode because of high instantaneous power loss if constant current control is used.

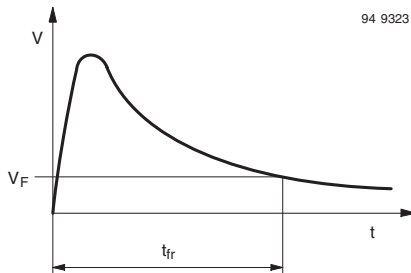

Figure 3.

### Voltage Regulator Diodes and Z-diodes

A voltage regulator diode is a diode which develops an essentially constant voltage across its terminals throughout a specified current range.

Special reverse-biased diodes known as Z-diodes and certain forward-biased silicon diodes can be used as voltage regulator diodes.

Z-diodes are silicon diodes which result from a specified applied reverse voltage onward in a rapid increase of reverse current avalanche or Z-breakdown voltage. These diodes are operated permanently in this breakdown region.

Due to the sharp rise of the reverse current the corresponding breakdown voltage is nearly constant.

Z-diodes are used for voltages above 2.4 V. If lower operating voltages are needed, the above mentioned forward-biased silicon diodes can be used.

#### Operating or working voltage, in the breakdown region, $V_Z$

Voltage across the terminals of a Z-diode for a specified value of reverse current in the breakdown region.

#### Operating or working current in the breakdown region, $I_Z$

Reverse current flowing in an allowable area of the breakdown region of a Z-diode.

#### Differential resistance in the breakdown region, $r_z$

Differential quotient between operating voltage and operating current for a specified working current.

$$r_z = \frac{dV_Z}{dI_Z}$$

This value is the sum of inherent ( $r_z$ ) and thermal differential ( $r_{zth}$ ) resistances.

$$r_z = r_{zj} + r_{zth}$$

#### Inherent differential resistance, $r_{zj}$ , in the breakdown region

This value is a part of the total differential resistance of a Z-diode in the breakdown region. It is responsible for short-time load change and constant junction temperature.

$$r_{zj} = \left( \frac{\delta V_Z}{\delta I_Z} \right) T_j = \text{constant}$$

It is valid for the case where the frequency of load changes is so high that the junction temperature does not change.

#### Thermal differential resistance, $r_{zth}$ , in the breakdown region

The thermal differential resistance is a result of the thermal characteristics of the diode. This should be considered together with inherent differential resistance,  $r_{zj}$ .

$$\begin{aligned} r_{zth} &= \frac{dT_j}{dI_Z} \times \left( \frac{\delta V_Z}{\delta T_j} \right) I_Z = \text{constant} \\ &= U_Z \times R_{thJA} \times TK_{VZ} \end{aligned}$$

#### Measuring current, $I_Z$

The value given in technical data serves as a measuring condition for the operating voltage,  $V_Z$ , inherent differential resistance,  $r_z$ , and the temperature coefficient of the operating voltage,  $TK_{VZ}$ .

#### Temperature coefficient, $TK_{VZ}$

This characteristic gives the temperature dependence of the operating voltage for a specified operating current such as

$$TK_{VZ} = \frac{1}{V_Z} \times \frac{dV_Z}{dt}$$

The unit of measurement used is either %/°C or  $10^{-4}/^\circ\text{C}$

#### Z-voltage, $V_Z$

See operating or working voltage

#### Z-current, $I_Z$

See operating or working current

#### Z-resistance, $r_z$

See differential resistance

### Varicap Diodes

Varicap diodes are used in different circuits, such as tuning, AFC, frequency multiplier, modulation, couple element in filters with controlled bandwidth, parametric amplification, switching in the VHF- and microwave regions, etc. In all these applications, the basic variation of junction capacitance with reverse voltage has been investigated.

A simplified equivalent circuit of an encapsulated Varicap diode is shown in figure 4.

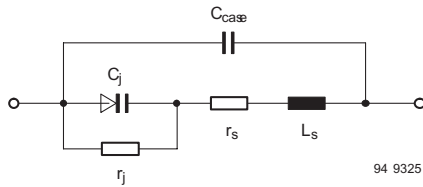

Figure 4.

- $C_{case}$  = Case capacitance
- $C_j$  = Junction capacitance
- $r_s$  = Series resistance
- $L_s$  = Series inductance
- $r_j$  = Junction resistance

In the case of silicon (Varicap) diodes, the junction resistance,  $r_j$ , is very high at zero or negative (reverse) bias. At high resonant frequency,  $C_{case}$  can be neglected and the equivalent circuit is the one shown in figure 5.

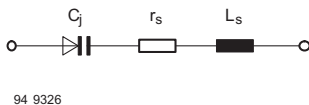

Figure 5.

Junction capacitance  $C_j$  can be calculated as follows:

$$C_j = \frac{C_{j0}}{\left(\frac{1 + V_R}{V_D}\right)^n}$$

- $C_{j0}$  = Junction capacitance at zero bias ( $V_R = 0$ )
- $V_D$  = Diffusion voltage, 0.7 V for silicon
- $n$  = The exponent  $n$  has different values according to the technology used, such as:
- $n = 0.33$ -diffused diode with linear technology
- $n = 0.5$ -abrupt pn junction, planar epitaxial technology
- $n \geq 0.75$ -diode with retrograded junction

$n = 0.5$ -abrupt pn junction, planar epitaxial technology

$n \geq 0.75$ -diode with retrograded junction

Retrograded junction diodes ( $n \geq 0.75$ ) are capable of very large capacitance deviation and are therefore suitable for tuning with large frequency range (i.e., BB205 for VHF). For these diodes,  $n$  is a function of reverse voltage, i.e.,  $n = f(V_R)$ . The quality,  $Q$ , of the Varicap is an important factor and can be calculated as follows:

$$Q = \frac{1}{2\pi \times f \times C_j \times r_s}$$

The series resistance,  $r_s$ , decreases with the increasing applied bias. It is also frequency dependent. The non-linearity of a capacitance characteristic results in a signal distortion or deformation due to the ratio of a signal amplitude to the applied bias.

In push-pull arrangements one can further minimize the distortion even with a larger range of signal.

Because the signal modulates the diode in counter phase, the capacitance changes. The diode is now almost compensated.

The temperature coefficient of the junction capacitance is approximately  $3 \times 10^{-4}/^\circ\text{C}$  with  $V_R = 3 \text{ V}$ . It is a result of a change of  $-2 \text{ mV}/^\circ\text{C}$  in diffusion voltage,  $V_D$ . The temperature coefficient of the junction capacitance decreases with increasing reverse voltage.

The junction resistance,  $r_j$ , decreases 6 % and the series resistance,  $r_s$ , decreases approximately 1 % with an increase in the junction temperature of  $1^\circ\text{C}$ .

### PIN Diodes

PIN stands for p-intrinsic-n. In this type of diode, a heavily doped p region and a heavily doped n region are separated by a layer of high resistivity material which is nearly intrinsic (I), as shown in figure 6. Under reverse bias, the PIN diode has a very high impedance (at microwave frequencies), whereas at moderate forward current it has a very low impedance.

This permits the use of the PIN diode as a low-loss switch with small self capacitance.

The RF resistance of the diode can be varied continuously from large to small values by changing the diode bias. The PIN diode can therefore be used more advantageously as an HF attenuator in a  $\pi$  or T-circuit.

Typical examples are: VHF-band switch diode BA282, BA682 and attenuator diode BA479G and BA679.

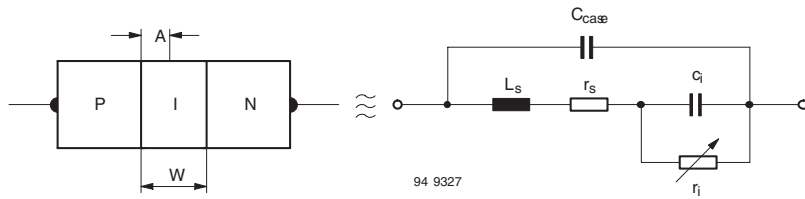

Figure 6.

- $W$  = Width of the I-Zone
- $A$  = Space charge carrier area
- $L_S$  = Total series inductance
- $r_s$  = Total resistance of the p and n layers and any resistance associated with the contacts of these
- $C_i$  = Layers  $r_i$  and represent the resistance and capacitance of the portion of the I-layer exclusive of the swept-out region.



## Taping of Diodes

### Axial Lead Components

Diodes and rectifiers with axial leads are normally delivered in taped form according to IEC 286-1 (see figure 1). The cathode side is designated by a colored tape. Taped devices are normally delivered in ammo-boxes (Ammopack). Delivery on reels is available on request.

Diodes in DO-35 packages are also available with 26 mm tapewidth and radial taped.

For details please contact factory.

Quantities per box dimensions  
264 (L) x 146 (H) x 73 (W)

Package	Available Packaging		
	10'' tape & reel	14'' tape & reel	Ammo Pack #1
	Quantity / Reel	Quantity / Reel	Quantity / Box
SOD-57	5.000		5.000
SOD-64	2.500		2.500
DO-35		10.000	10.000
DO-41		5.000	5.000

### Taping Specifications DO-35, DO-41, SOD-57 and SOD-64 Package

Description	Symbol	Specification (mm)
Component Pitch	A	$5.0 \pm 0.5$
Devices with diameter	d	$< 4.5$
Component Pitch	A'	$10 \pm 0.5$
Devices with diameter	d'	$> 4.5$
Inside Tape Spacing	B	$52 + 2 \text{ mm} - 1 \text{ mm}$
Lead to Lead Eccentricity	ID1-D2I	1.4 max
Lead Extension	K	0
Lead Bending	M	1.2 max
Cumulative Pitch	P	2.0 per 10 pitch
Exposed Adhesive	S	0.8 max
Tape Width	T	$6.0 \pm 0.4$
Tape Leader	Beginning and end of reel or ammo pack.	
Empty Spaces	Consecutive missing components not allowed	
Polarity Marking	All polarized components shall be oriented in the same direction. The cathode tape shall be colored, and anode tape shall be white or light beige.	

Allowable deviation above 10 taped steps  $\pm 2 \text{ mm}$

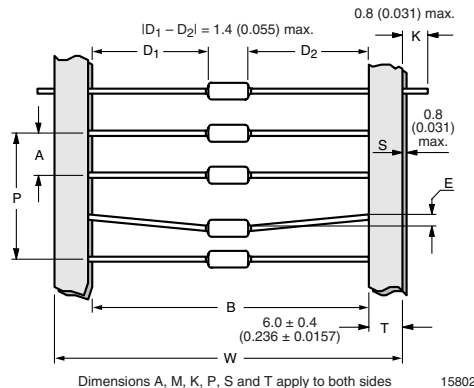

Figure 1.

## Vishay Semiconductors

### Ammopack #1 Specification (DO-35, DO-41, SOD-57 and SOD-64 Packages)

Description	Symbol	Specification	
		Inches	Millimeters
Length	A	10.25 ± 0.2	260 ± 5.0
Width	B	2.75 ± 0.2	70 ± 5.0
Height	C	5.75 ± 0.65	146 ± 16.0

Material: corrugated board (neutral)

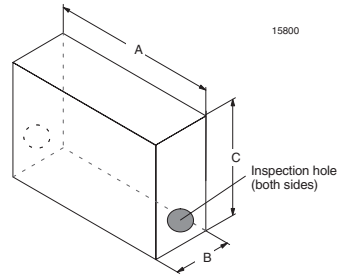

Figure 2.

### Reel Specification

Description	Symbol	Reel Size 10"	Reel Size 14"
		SOD-57 SOD-64	DO-35 DO-41
Arbor Hole Diameter	$D_0$	55 mm	30 ± 1 mm
Core Diameter	$D_1$	60 mm	80 ± 1 mm
Reel Diameter	$D_2$	250 mm	355 mm
Drive Hole Diameter	$D_3$	-	8 ± 0.5 mm
Reel Width	$W_1$	69 mm	73 mm
Drive / Arbor Hole Spacing	$W_2$	-	26 ± 0.5 mm
Core Material		Plastic	Carton
Reel Material		Plastic	Carton

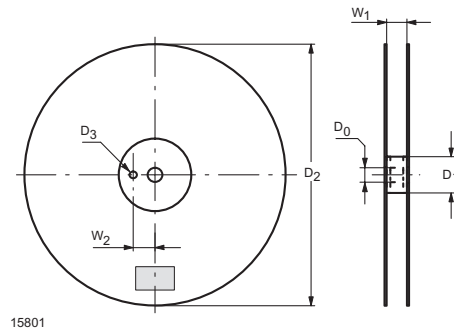

Figure 3.

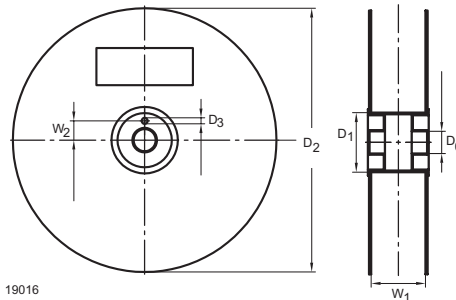

Figure 4.

## Tape and Reel Surface-Mounted Devices (SMDs)

SMDs are normally delivered taped on blister tape and reeled according to IEC 286–3. The mounting side of the component is oriented to the bottom side of the tape. For components with two terminations, the cathode side is oriented to the sprocket hole. For components in SOT-23 package, the side from which one single termination emerges is oriented to the sprocket hole. Components can be delivered either on 180 mm or on 330 mm reels. For quantities per reel, see below.

Case Type	Suffix	Quantity	Reel Size in mm (Diameter)	Tape Width in mm
DO-214AC	TR	1500	180	12
	TR3	6000	330	12
LLP75-3B	GS08	3000	180	8
	GS18	10000	330	8
LLP75-6A	GS08	3000	180	8
	GS18	10000	330	8
MicroMELF	TR	2500	180	8
	TR3	10000	330	8
MiniMELF SOD-80	GS08	2500	180	8
	GS18	10000	330	8
QuadroMELF SOD-80	GS08	2500	180	8
	SG18	10000	330	8
SMF (DO-219AB)	GS08	3000	180	8
	GS18	10000	330	8
SO-8	GS18	2500	330	8
SOD-123	GS08	3000	180	8
	GS18	10000	330	8
SOD-323	GS08	3000	180	8
	GS18	10000	330	8
SOD-523	GS08	3000	180	8
SOT-23	GS08	3000	180	8
	GS18	10000	330	8
SOT-363	GS08	3000	180	8
	GS18	10000	330	8
SOT-490	GS08	3000	180	8



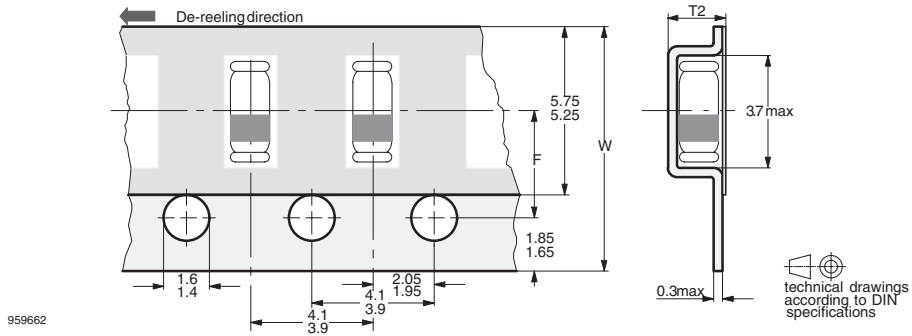

Figure 5.

Packages / Devices	Dimensions (mm)			
	W	F	T2	B
MiniMELF, SOD-80 MicroMELF, SOD-80 QuadroMELF, SOD-123, SOD-323, SOT-23	8 ± 0.3	3.5 ± 0.05	2.5 mm max.	8.4 to 10.4

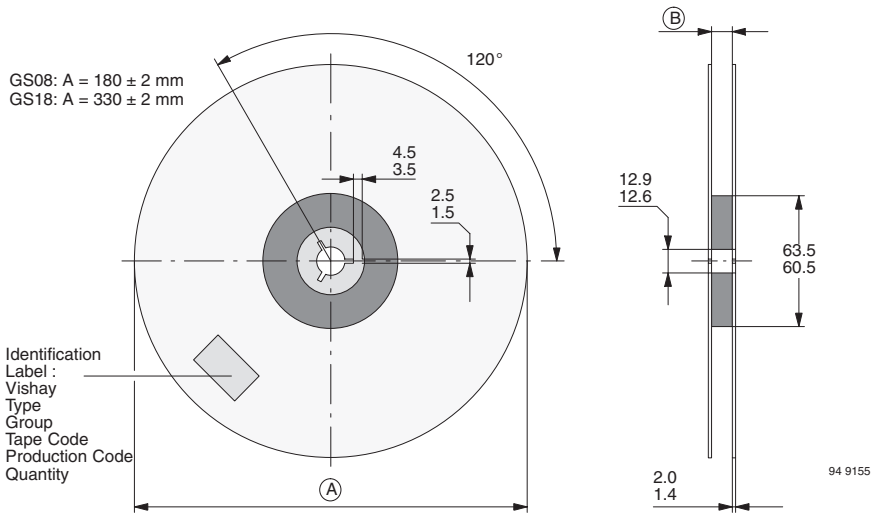

Figure 6.

### Missing devices

A maximum of 0.5 % of the total number of components per reel may be missing – exclusively at the beginning and at the end of the reel. A maximum of three consecutive components may be missing, provided this gap is followed by six consecutive components (see figure 7).

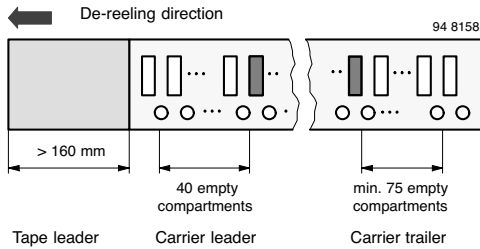

Figure 7.

### Labelling



18916

Figure 8. Labelling of taping reel



18917

Figure 9. Labelling of carton box



## Quality Information

### Vishay Semiconductors' Continuous Improvement Activities

- Quality training for ALL personnel including production, development, marketing and sales departments
- Zero defect mindset
- Permanent quality improvement process
- Total Quality Management (TQM)
- Vishay Semiconductors' Quality Policy established by the Management Board
- Quality system certified per ISO 9001: 2000
- Quality system certified per ISO/TS 16949: 2002
- Environmental System certified per ISO14001
- Work Safety system certified per OHSAS18001

### Vishay Semiconductors' Tools for Continuous Improvement

- Vishay Semiconductors follows the Rules of the EFQM - Quality - Management system
- Vishay Semiconductors qualifies materials, processes and process changes
- Vishay Semiconductors uses Process FMEA (Failure Mode and Effects Analysis) for all processes. Process and machine capability as well as Gauge R&R (Repeatability & Reproducibility) are proven
- Vishay Semiconductors internal qualifications correspond to IEC68-2, MIL STD 750 and AEC-Q101
- Vishay Semiconductors periodically requalifies device types (Long Term Monitoring).
- Vishay Semiconductors uses SPC for significant production parameters. SPC is performed by trained operators.
- Vishay Semiconductors' 2 x 100 % testing of final products.
- Vishay Semiconductors' lot release is carried out via sampling. Sampling acceptance criterion is always  $c = 0$ .

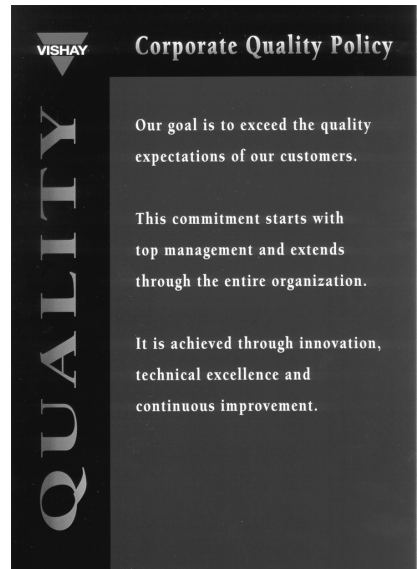

The graphic features a dark background with a vertical bar on the left containing the word "QUALITY" in large, white, serif capital letters. At the top of this bar is a small inverted triangle with the word "VISHAY" inside. To the right of the bar, the title "Corporate Quality Policy" is written in a serif font. Below the title, three paragraphs of text are presented in a smaller serif font, each preceded by a small white square bullet point.

**VISHAY** **Corporate Quality Policy**

Our goal is to exceed the quality expectations of our customers.

This commitment starts with top management and extends through the entire organization.

It is achieved through innovation, technical excellence and continuous improvement.

16966

# Vishay Semiconductors

## Create First-Class Quality, On-Time Delivery, And Satisfy Customers' Requirements



18587

Figure 1. Vishay Semiconductor Ges.m.b.H, A-Voecklabruck  
ISO 14001 : 1996

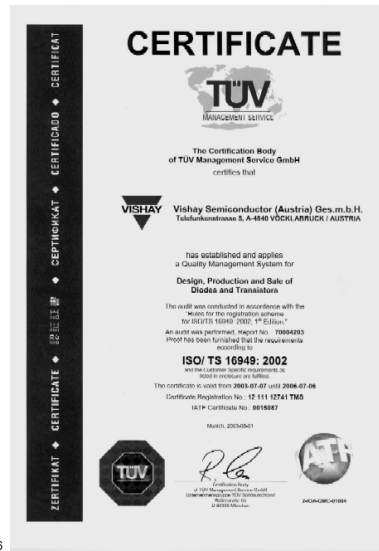

18586

Figure 3. Vishay Semiconductor Ges.m.b.H, A-Voecklabruck  
ISO TS 16949 : 2002



18771

Figure 2. Vishay Semiconductor Ges.m.b.H, A-Voecklabruck  
ISO 9001 : 2000

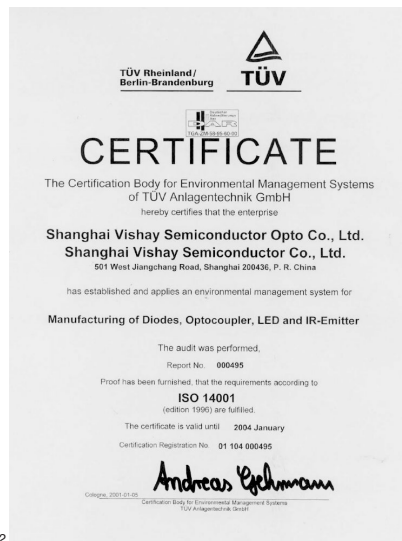

18592

Figure 4. Shanghai Vishay Semiconductor Co., Ltd., China  
ISO 14001 : 1996



18772

Figure 5. Shanghai Vishay Semiconductor Co., Ltd., China  
ISO/TS 16949 : 2002

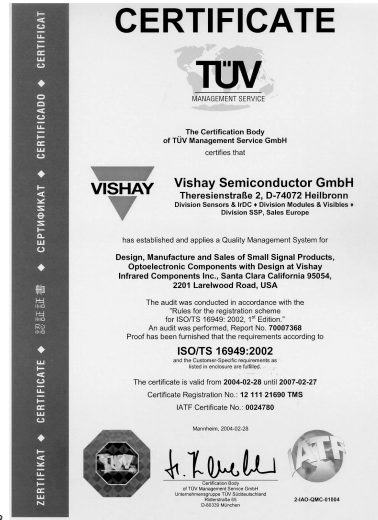

19018

Figure 7. Vishay Semiconductor GmbH, D-Heilbronn  
ISO TS 16949 : 2002

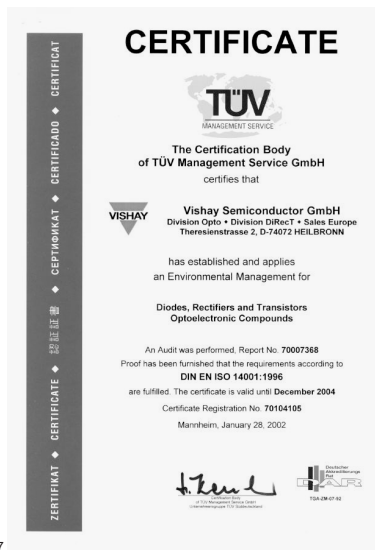

19017

Figure 6. Vishay Semiconductor GmbH, D-Heilbronn  
ISO 14001 : 1996

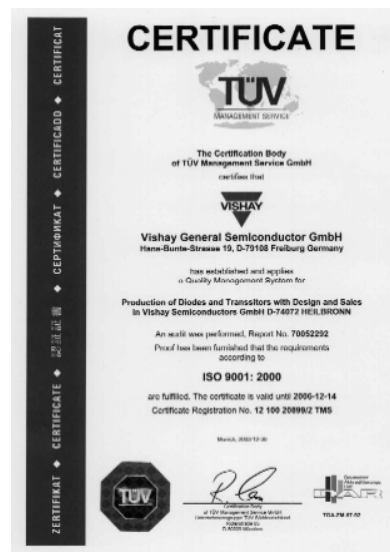

18812

Figure 8. Vishay General Semiconductor GmbH, D-Freiburg  
ISO 9001 : 2000

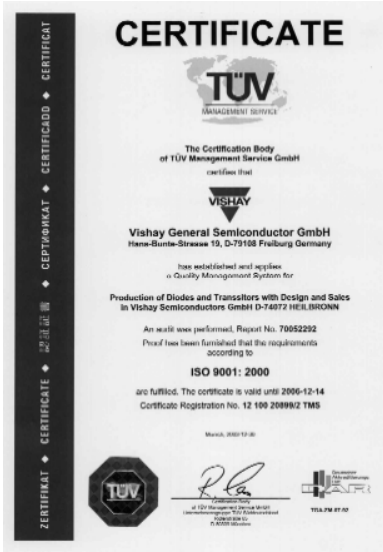

18811

Figure 9. Vishay General Semiconductor GmbH, D-Freiburg  
QS 9000 : 1998

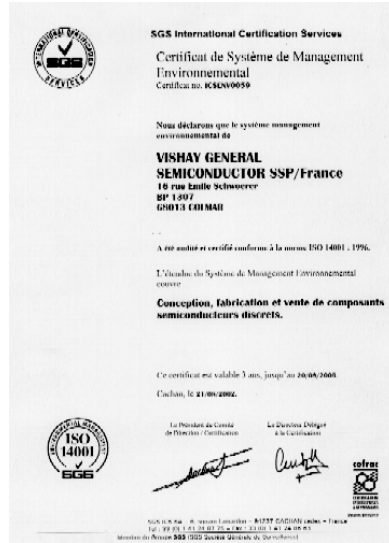

18788

Figure 11. Vishay General Semiconductor S.A.S, F-Colmar  
ISO 14001 : 1996



18793

Figure 10. Vishay General Semiconductor GmbH, D-Freiburg  
ISO 14001 : 1996

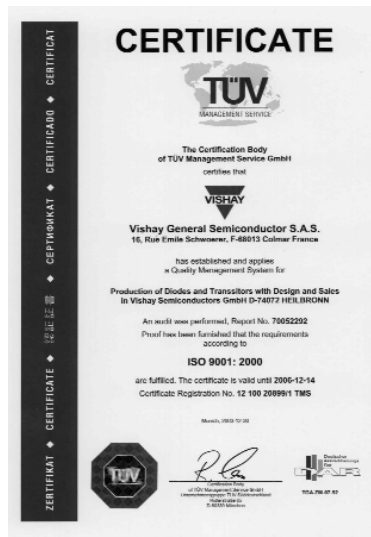

18814

Figure 12. Vishay General Semiconductor S.A.S, F-Colmar  
ISO 9001 : 2000

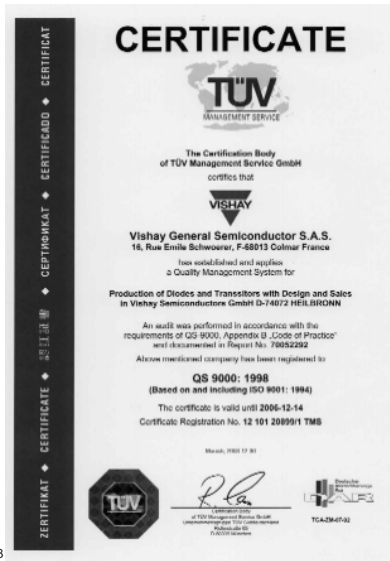

18813

Figure 13. Vishay General Semiconductor S.A.S, F-Colmar  
QS 9000 : 1998

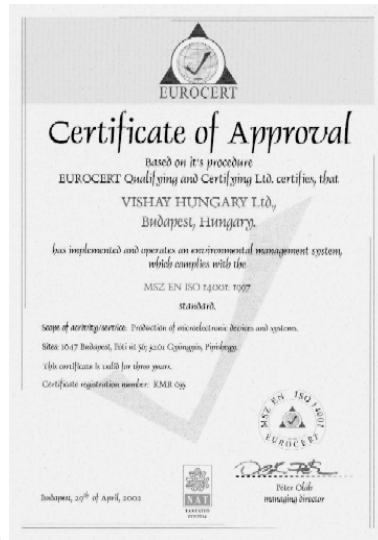

18773

Figure 15. Vishay Hungary Ltd., H-Budapest, H-Gyöngyös  
ISO 14001 : 1997



18775

Figure 14. Vishay Hungary Electronics CO., H-Budapest  
ISO/TS 16949 : 2002



18774

Figure 16. Vishay Hungary Electronics CO., H-Gyöngyös  
ISO/TS 16949 : 2002



General Quality Flow Chart

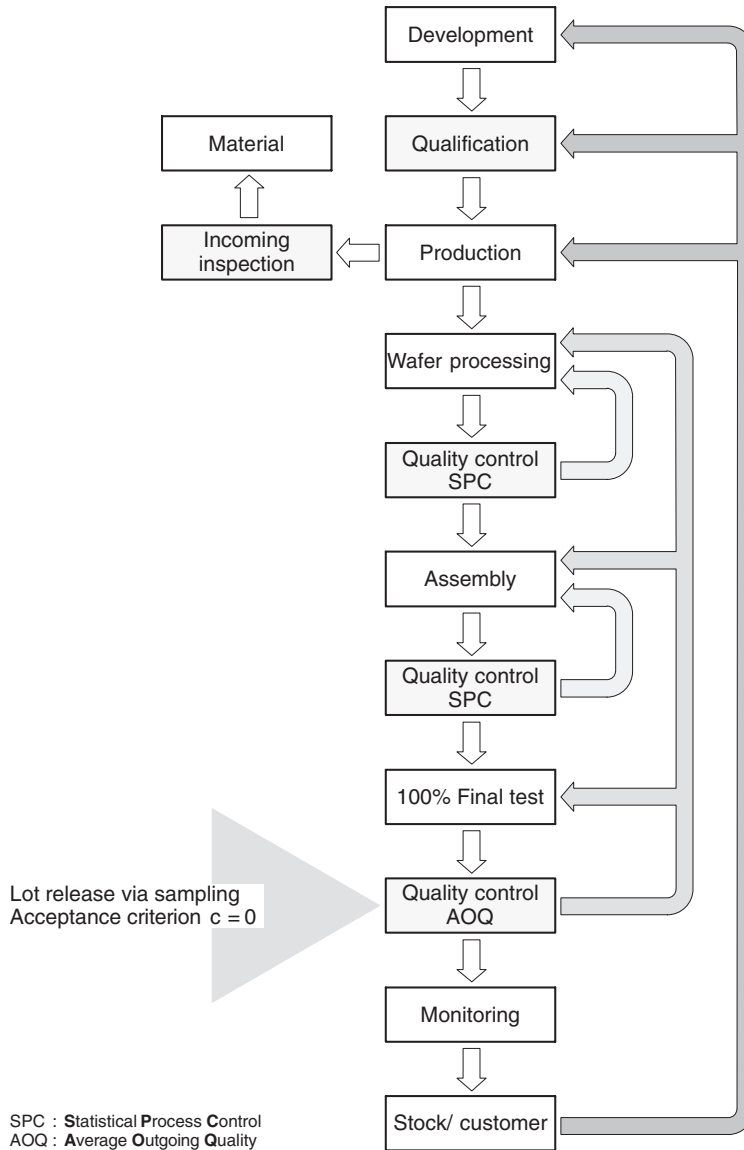

95 11464

### Vishay Quality Road Map

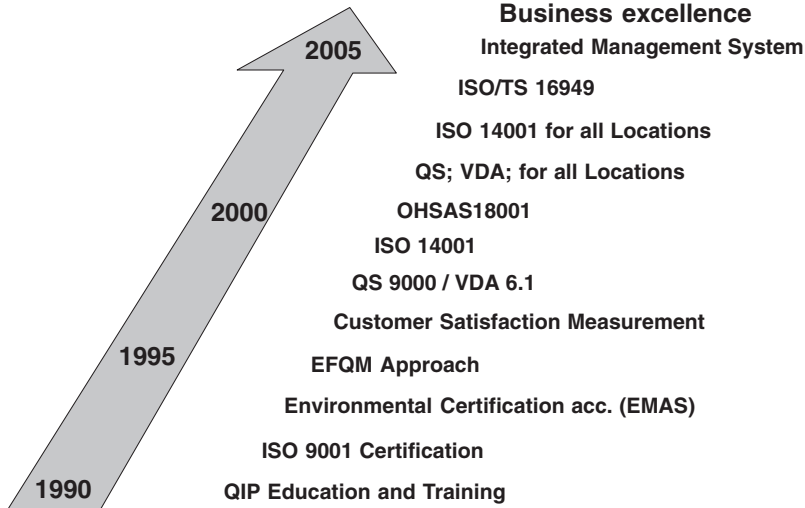

18667

### Qualification and Release

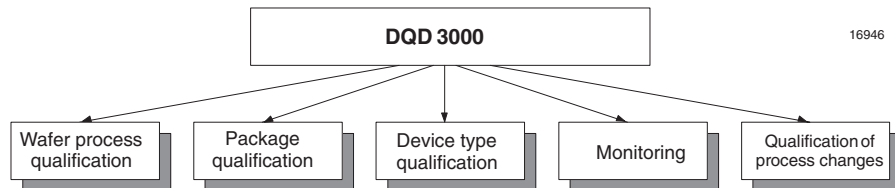

16946

Figure 17. Structure of DQD 3000

New wafer processes, packages and device types are qualified according to the internal Vishay Semiconductors specification DQD 3000.

DQD 3000 consists of five parts (see Figure 15).

**Wafer process release:** The wafer process release is the fundamental release qualification for the various technologies used by Vishay Semiconductors. Leading device types are defined for various technologies. Three wafer lots of these types are subjected

to an extensive qualification procedure and are used to represent this technology. A positive result will lead to release of the technology.

**Package release:** The package release is the fundamental release qualification for the different packages used. Package groups are defined.

Critical packages are selected: two assembly lots are subjected to the qualification procedure represented. A positive result will release all similar packages.

---

## Vishay Semiconductors

**Device type release:** The device type released is the release of individual designs.

**Monitoring:** Monitoring serves both as the continuous monitoring of the production and as a source of data for calculation of early failures (early failure rate: EFR).

**Product or process changes** are released via ECN (Engineering Change Note). This includes proving process capability and meeting the quality requirements.

Test procedures utilized are IEC 68-2-... and MIL-STD-750 respectively.

### Statistical Methods for Prevention

To manufacture high-quality products, it is not sufficient to inspect the product at the end of the production process.

Quality has to be 'designed-in' during process and product development. In addition to that, the 'designing-in' must also be ensured during production flow. Both will be achieved by means of appropriate measurements and tools.

- Statistical Process Control (SPC)
- R&R- (Repeatability and Reproducibility) tests
- Up-Time Control (UTC)
- Failure Mode and Effect Analysis (FMEA)
- Design Of Experiments (DOE)
- Quality Function Deployment (QFD)

Vishay has been using SPC as a tool in production since 1990/91.

By using SPC, deviations from the process control goals are quickly established. This allows control of the processes before the process parameters run out of specified limits. To assure control of the processes, each process step is observed and supervised by trained personnel. Results are documented.

Process capabilities are measured and expressed by the process capability index ( $C_{pk}$ ).

Validation of the process capability is required for new processes before they are released for production.

Before using new equipment and new gauges in production, machine capability ( $C_{mk}$  = machine capability index) or R&R (Repeatability & Reproducibility) is used to validate the equipment's fitness for use.

Up-Time is recorded by an Up-Time Control (UTC) system. This data determines the intervals for preventive maintenance, which is the basis for the maintenance plan.

A process-FMEA is performed for all processes (FMEA = Failure Mode and Effect Analysis). In addition, a design- or product-FMEA is used for critical products or to meet agreed customer requirements.

Design of Experiments (DOE) is a tool for the statistical design of experiments and is used for optimization of processes. Systems (processes, products and procedures) are analyzed and optimized by using designed experiments.

A significant advantage compared to conventional methods is the efficient performance of experiments with minimum effort by determining the most important inputs for optimizing the system.

As a part of the continuous improvement process, all Vishay employees are trained in TQM thinking and in using new statistical methods and procedures.

## Reliability

The requirements concerning quality and reliability of products are always increasing. It is not sufficient to only deliver fault-free parts. In addition, it must be ensured that the delivered goods serve their purpose safely and failure of free, i.e. reliably. From the delivery of the device and up to its use in a final product, there are some occasions where the device or the final product may fail despite testing and outgoing inspection.

In principle, this sequence is valid for all components of a product.

For these reasons, the negative consequences of a failure, which become more serious and expensive the later they occur, are obvious. The manufacturer is therefore interested in supplying products with the lowest possible

- AOQ (Average Outgoing Quality) value
- EFR (Early Failure Rate) value
- LFR (Long-term Failure Rate) value

### Average Outgoing Quality (AOQ)

All outgoing products are sampled after 2 x 100 % testing. This is known as "Average Outgoing Quality" (AOQ). The results of this inspection are recorded in ppm (parts per million) using the method defined in JEDEC 16.

### Early Failure Rate (EFR)

EFR is an estimate (in ppm) of the number of early failures related to the number of devices used. Early failures are normally those which occur within the first 300 to 1000 hours. Essentially, this period of time covers the guarantee period of the finished unit.

Low EFR values are therefore very important to the device user. The early life failure rate is heavily influenced by complexity. Consequently, 'designing-in' of better quality during the development and design phase, as well as optimized process control during manufacturing, significantly reduces the EFR value. Normally, the early failure rate should not be significantly higher than the random failure rate. EFR is given in ppm (parts per million).

### Long-Term Failure Rate (LFR)

LFR shows the failure rate during the operational period of the devices. This period is of particular interest to the manufacturer of the final product. Based on the LFR value, estimations concerning long-term failure rate, reliability and a device's or module's opera-

tional life may be derived. The usage life time is normally the period of constant failure rate. All failures occurring during this period are random.

Within this period the failure rate is:

$$\lambda = \frac{\text{Sum of failures}}{\Sigma(\text{Quantity} \times \text{Time to failure})} \times \frac{1}{\text{hours}}$$

The measure of  $\lambda$  is FIT (Failures In Time = number of failures in 10<sup>9</sup> device hours).

### Example

A sample of 500 semiconductor devices is tested in a operating life test (dynamic electric operation). The devices operate for a period of 10,000 hours.

Failures:

- 1 failure after 1000 h
- 1 failure after 2000 h

The failure rate may be calculated from this sample by

$$\lambda = \frac{2}{1 \times 1000 + 1 \times 2000 + 498 \times 10000} \times \frac{1}{h}$$

$$\lambda = \frac{2}{4983000} \cdot \frac{1}{h} = 4.01 \times 10^{-71} \frac{1}{h}$$

This is a  $\lambda$ -value of 400 FIT, or this sample has a failure rate of 0.04 % / 1000 h on average.

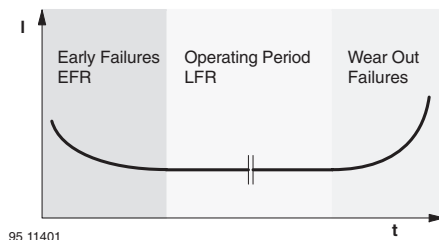

Figure 1. Bath tub curve

## Confidence Level

The failure rate  $\lambda$  calculated from the sample is an estimate of the unknown failure rate of the lot.

The interval of the failure rate (confidence interval) may be calculated, depending on the confidence level and sample size.

The following is valid:

- The larger the sample size, the narrower the confidence interval.
- The lower the confidence level of the statement, the narrower the confidence interval.

The confidence level applicable to the failure rate of the whole lot when using the estimated value of  $\lambda$  is derived from the  $\chi^2$ -distribution. In practice, only the upper limit of the confidence interval (the maximum average failure rate) is used.

Therefore:

$$\lambda_{max} = \frac{\chi^2/2r;PA}{n \times t} \quad \text{in } \frac{1}{h}$$

$$LFR = \frac{\chi^2/2(r;PA)}{n \times t} \times 1 \times 10^9 \quad \text{in [FIT]}$$

r: Number of failures

PA: Confidence level

n: Sample size

t: Time in hours

n x t: Device hours

The  $\chi^2/2$  for  $\lambda$  are taken from Table1.

For the above example from Table1:

$\chi^2/2$  (r = 2; PA = 60 %) = 3.08

n x t = 4983000 h

$$\lambda_{max} = \frac{3,08}{4983000} = 6,8 \times 10^{-7} \frac{1}{h}$$

This means that the failure rate of the lot does not exceed 0.0618 % / 1000 h (618 FIT) with a probability of 60 %.

If a confidence level of 90 % is chosen from table 1:

$\chi^2/2$  (r = 2; PA = 90 %) = 5.3

$$\lambda_{max} = \frac{5,3}{4983000} = 1,06 \times 10^{-6} \frac{1}{h}$$

This means that the failure rate of the lot does not exceed 0.106 % / 1000 h (1060 FIT) with a probability of 90 %.

Number of Failures	Confidence Level			
	50 %	60 %	90 %	95 %
0	0.60	0.93	2.31	2.96
1	1.68	2.00	3.89	4.67
2	2.67	3.08	5.30	6.21
3	3.67	4.17	6.70	7.69
4	4.67	5.24	8.00	9.9
5	5.67	6.25	9.25	10.42
6	6.67	7.27	10.55	11.76
7	7.67	8.33	11.75	13.16
8	8.67	9.35	13.00	14.30
9	9.67	10.42	14.20	15.63
10	10.67	11.42	15.40	16.95

Table 1:

## Operating Life Tests

Number of devices tested: n = 50

Number of failures:

(positive qualification): c = 0

Test time: t = 2000 hours

Confidence level: PA = 60 %

$\chi^2/2$  (0; 60 %) = 0.93

$$\lambda_{max} = \frac{0,93}{50 \times 2000} = 9,3 \times 10^{-6} \frac{1}{h}$$

This means, that the failure rate of the lot does not exceed 0.93 % / 1000 h (9300 FIT) with a probability of 60 %.

This example demonstrates that it is only possible to verify LFR values of 9300 FIT with a confidence level of 60 % in a normal qualification test (50 devices, 2000 h).

To obtain LFR values which meet today's requirements (< 50 FIT), the following conditions have to be fulfilled:

- Very long test periods
- Large quantities of devices
- Accelerated testing (eg higher temperature)

### Mean Time to Failure (MTTF)

For systems which can not be repaired and whose devices must be changed, e.g. semiconductors, the following is valid:

$$MTTF = \frac{1}{\lambda}$$

MTTF is the average fault-free operating period per a monitored (time) unit.

### Accelerating Stress Tests

Innovation cycles in the field of semiconductors are becoming shorter and shorter. This means that products must be brought to the market quicker. At the same time, expectations concerning the quality and reliability of the products have become higher.

Manufacturers of semiconductors must therefore assure long operating periods with high reliability but in a short time. Sample stress testing is the most commonly used way of assuring this.

The rule of Arrhenius describes this temperature-dependent change of the failure rate.

$$\lambda(T_2) = \lambda(T_1) \times e^{\left[ \frac{E_A}{k} \times \left( \frac{1}{T_1} - \frac{1}{T_2} \right) \right]}$$

Boltzmann's constant

$$k = 8.63 \times 10^{-5} \text{ eV/K}$$

Activation energy

$E_A$  in eV

Junction temperature real operation

$T_1$  in Kelvin

Junction temperature stress test

$T_2$  in Kelvin

Failure rate real operation

$\lambda(T_1)$

Failure rate stress test

$\lambda(T_2)$

The acceleration factor is described by the exponential function as being:

$$AF = \frac{\lambda(T_2)}{\lambda(T_1)} = e^{\left[ \frac{E_A}{k} \times \left( \frac{1}{T_1} - \frac{1}{T_2} \right) \right]}$$

### Example

The following conditions apply to an operating life stress test:

Environmental temperature during stress test

$$T_A = 70 \text{ }^\circ\text{C}$$

Power dissipation of the device

$$P_V = 100 \text{ mW}$$

Thermal resistance junction/environment

$$R_{thJA} = 300 \text{ K/W}$$

The system temperature / junction temperature results from:

$$T_J = T_A + R_{thJA} \times P_V$$

$$T_J = 70 \text{ }^\circ\text{C} + 300 \text{ K/W} \times 100 \text{ mW}$$

$$T_J = 100 \text{ }^\circ\text{C}$$

Operation in the field at an ambient temperature of 50 °C and at an average power dissipation of 80 mW is utilized. This results in a junction temperature in operation of  $T_J = 74 \text{ }^\circ\text{C}$ . The activation energy used for opto components is  $E_A = 0.8 \text{ eV}$ .

The resulting acceleration factor is:

$$AF = \frac{\lambda(373K)}{\lambda(347K)} = e^{\left[ \frac{E_A}{k} \times \left( \frac{1}{347K} - \frac{1}{373K} \right) \right]}$$

$AF \approx 6.5$

This signifies that, in this example, the failure rate is lower by a factor of 6.5 compared to the stress test.

Other accelerating stress tests may be:

- Humidity (except displays type TDS.)  
 $T_A = 85 \text{ }^\circ\text{C}$   
 $RH = 85 \%$
- Temperature cycling  
Temperature interval as specified

The tests are carried out according to the requirements of appropriate IEC-standards (see also chapter 'Qualification and Release').

## Vishay Semiconductors

### Activation Energy

There are some conditions which need to be fulfilled in order to use Arrhenius' method:

- The validity of Arrhenius' rule has to be verified.
- 'Failure-specific' activation energies must be determined.

These conditions may be verified by a series of tests. Today, this procedure is generally accepted and used as a basis for estimating operating life. The values of activation energies can be determined by experiments for different failure mechanisms.

Values often used for different device groups are:

Opto components	0.8 eV
Bipolar ICs	0.7 eV
MOS ICs	0.6 eV
Transistors	0.7 eV
Diodes	0.7 eV
Sinterglass Diodes	0.7 eV

By using this method, it is possible to provide long-term predictions for the actual operation of semiconductors even with relatively short test periods.

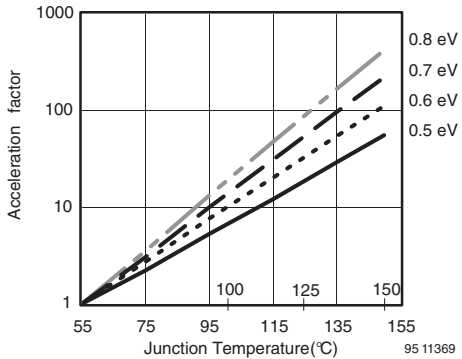

Figure 2. Acceleration factor for different activation energies normalized to  $T_j = 55^\circ\text{C}$

## The Constituents of Semiconductor Components

Responsible electronic component and equipment manufacturers are already preparing for the time when the lifespan of their products comes to an end by scrutinizing the materials incorporated and their future recyclability. Recycling laws have already come into force in Germany ("Kreislauf-Wirtschaftsgesetz") and guidelines for electronic scrap are in preparation.

The aim is a suitable waste disposal program and \_ as a preventative measure \_ a reduction in the content of hazardous damaging materials in such components. In order to conform to this procedure, detailed information about the materials and their quantities is needed.

This present overview answers questions put forward by customers as to the constituents and their function in the most important of Vishay Semiconductor's semiconductor products. Special significance is given to so-called "Hazardous Substances". It demonstrates that Vishay Semiconductor products under normal operating conditions do not expose the applier or environment to any hazard. However, most products nevertheless contain small but necessary quantities of "Hazardous Substances" which can \_ if not treated correctly or through accidents \_ be released on a small scale into the environment.

The present information was produced with the greatest possible care. Any suggestions for improvement of this brochure are welcome.

### Definitions

Vishay Semiconductor offers a wide range of semiconductor components including transistors, diodes and opto-electronic components. These have been manufactured in various standard packages. On the following pages, these packages are listed together with their materials shown in weight percentages. In order to limit the number of tables, all components whose structure and composition are the same have been compiled in families. In many cases, different lead frames together with chips of different sizes may be used for the one package. This usually means that there may be slight differences in the quantities of the declared material. The weight percent is, however, valid for a representative sample of the relevant family. In order to sensibly reduce the number and quantities of materials contained in the respective components, quantities smaller than 0.1% by weight have been stated in the following list as **traces**. This is the case unless lower limits are forced by law, e.g., cadmium < 75 ppm and PCDD as well as PCDF

(known as dioxin) < 2 ppb. In the lists themselves, details of content and composition are separated into the individual parts of the semiconductor component. The most important of these are:

**Active element:** The active element is either a silicon chip or for optoelectronic components a chip containing combinations of Ga (Al) (As, P). These are doped with very small amounts of boron, arsenic, phosphorus, zinc and germanium etc. The metallization consists of thin layers of aluminium, gold or titanium. The chips are generally bonded to the lead frame with a silver epoxy and have gold or aluminium wires bonded to the lead frame.

**Lead frame:** For electrical connection, a metal lead frame made from alloys such as FeNi (42) or CuFe (2) and partly or totally plated with silver is commonly used. The metal alloys contain traces of silver, zinc and phosphorus.

**Case:** The semiconductor chip is protected from the environment by a case of glass, plastic or metal. The glass is composed of oxides of silicon and lead together with boron and aluminium. Plastic cases are composed of an epoxy resin filled with up to 70 % by weight of quartz particles. Antimony trioxide and brominated epoxy resin (no TBA) are added as flame retardants. Antimony and bromine amount to about 1.6 and 1.0 % respectively.

**In use:** In use, it is the content of hazardous substances which is of importance. In Germany, there are a series of lists which give the materials which are potentially hazardous to people and the environment, for example:

Appendix II and IV of the "Hazardous Materials Regulations", the TRGS 900 ("MAK-Wert-Liste") and the "Catalog of Materials Hazardous to the Water Supply". These lists, however, are only partially consistent.

The names used are often different for materials with the same chemical composition. Furthermore, the use of trivial and trade names often adds to the confusion.

Vishay Semiconductor therefore for their descriptions use that proposed by the Zentralverband Elektrotechnik und Elektronikindustrie e.V. (ZVEI; Central Association of Electrical Engineering and Electronic Industry) for the harmonization of the nomenclature of hazardous substances.

Statements are made on the safety precautions to be used during storage and disposal by mechanical, chemical and thermal means of the more important





## Vishay Semiconductors

chemicals (so-called "Leitchemikalien"). These are listed in the tables in the order of their potential risk. Their effect upon people and the environment are also listed and any special precautions emphasized.

**Notes:** The following information has been prepared to be as exact and reliable as possible.

The manufacture of semiconductor components is, however, subject to regular change without special notification.

The publication of this brochure excludes any responsibility resulting from its use.

### Explanation of Abbreviations

While the information on weight percent is believed correct, discrepancies depending upon component type may be possible.

- 1) Material information etc. Material listed as "Material Hazardous in Production"
- 2) S: Trace material < 0.1% by weight;  
Cd < 75 ppm; concerning Cd see \*\*\*)  
PCDD and PCDF < 2 ppb
- \*) Dioxin content – lies below agreed limits
- \*\*) No. 85 "Rules for Hazardous Materials", to be replaced as soon as a technically suitable alternative material is available
- \*\*\*) Traces of cadmium can only be found in lead frames made of copper
- CMT: Material containing carcinogens, mutagens or terratogens
- Tox: Material is toxic or very toxic
- S Material with allergy producing characteristics
- HAL Halogen containing material
- WKG Material hazardous to the water supply
- L Storage, suitable for disposal
- D Disposable
- M Mechanical disposal
- N Chemical disposal
- T Thermal disposal
- H Handling

### Ozone Depleting Substances

The use of Ozone Depleting Substances has been totally eliminated by Vishay Semiconductor and by doing so meets the legal requirements as defined in the following documents.

1. The "Montreal Protocol" together with the "London Amendments" Appendix A, B, and the "List of Transitional Substances"
2. "Clean Air Act", Amendments 1990, "Environmental Protection Agency" (EPA), USA, Class I and II – Ozone Depleting Substances
3. "European Council Resolution" number 88/540/EEC and 91/690/eec Appendix A, B and C (Transitional Substances)

Vishay Semiconductor guarantees that its components do not contain and are manufactured without the use of Ozone Depleting Substances.

Declaration of Material Contents DO-214 Package

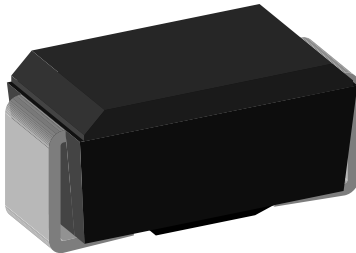

DO-214 Diode

Prohibited Substances		
Material	Limit ppm	ICP Analysis < ppm
Cadmium	5	5
Asbestos	0	0
Mercury	0	0
Chromium VI	2	0
Polychl. Biphenyle	0	0
Formaldehyde	0	0
Azo Compounds	0	0

MATERIAL CONTENT					
Part	Material	weight mg	% of weight	ppm of total weight	CAS N°
<b>Mold</b> <b>50.40 %</b>	SiO <sub>2</sub>	27.6	71.39 %	360739	14808-60-7
	epoxy resin	10.05	26.00 %	131356	25928-94-3
	Sb <sub>2</sub> O <sub>3</sub>	0.62	1.60 %	8104	1309-64-4
	Br	0.39	1.01 %	5097	7726-95-6
	<b>TOTAL</b>	<b>38.66</b>			
<b>Lead frame tinned</b> <b>46.20 %</b>	Cu	30.05	85.13 %	392761	7440-50-8
	Fe	3.3	9.35 %	43132	7439-89-6
	Sn	1.95	5.52 %	25487	7440-31-5
	<b>TOTAL</b>	<b>35.3</b>			
<b>Solder dip</b> <b>1.30 %</b>	Pb	0.8774	89.78 %	11468	7439-92-1
	Sn	0.997	10.20 %	1303	7440-31-5
	Ag	0.0002	0.02 %	3	7440-22-4
	<b>TOTAL</b>	<b>0.98</b>			
<b>Silicon chip</b> <b>2.10 %</b>	Si	1.2925	82.20 %	16893	7440-21-3
	Ag	0.2406	15.30 %	3145	7440-22-4
	Ni	0.0031	0.20 %	41	7440-02-0
	SiO <sub>2</sub>	0.0362	2.30 %	473	14808-60-7
	<b>TOTAL</b>	<b>1.57</b>			
<b>Total weight</b>		<b>77</b>			

# Vishay Semiconductors

## Declaration of Material Contents SOD-80 Package

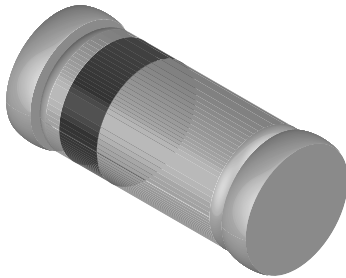

minimelf

MiniMELF Diode

Prohibited Substances		
Material	Limit ppm	ICP Analysis < ppm
Cadmium	5	5
Asbestos	0	0
Mercury	0	0
Chromium VI	2	0
Polychl. Biphenyle	0	0
Formaldehyde	0	0
Azo Compounds	0	0

MATERIAL CONTENT					
Part	Material	weight mg	% of weight	ppm of total weight	CAS N°
Leads Tinned 58.60 %	Fe	11.03	61.38 %	359138	7439-89-6
	Cu	4.86	27.05 %	158242	7440-50-8
	Ni	1.55	8.63 %	50468	7440-02-0
	Sn	0.48	2.67 %	15629	7440-31-5
	CuO	0.05	0.28 %	1628	1317-38-0
	<b>TOTAL</b>	<b>17.97</b>			
Package Glass 41.10 %	PbO	7.96	62.92 %	259179	1317-36-8
	SiO <sub>2</sub>	3.46	27.35 %	112658	14808-60-7
	K <sub>2</sub> O	0.97	7.67 %	31583	12136-45-7
	Na <sub>2</sub> O	0.09	0.71 %	2930	1313-59-3
	Al <sub>2</sub> O <sub>3</sub>	0.09	0.71 %	2930	1344-28-1
	BaO	0.08	0.63 %	2605	1304-28-5
<b>TOTAL</b>	<b>12.65</b>				
Silicon Chip 0.30 %	Si	0.0741	80.19 %	2413	7440-21-3
	Ag	0.0153	16.56 %	498	7440-22-4
	SiO <sub>2</sub>	0.0015	1.62 %	49	14808-60-7
	PbO	0.0013	1.41 %	42	1317-36-8
	Ni	0.0002	0.22 %	7	7440-02-0
	<b>TOTAL</b>	<b>0.0924</b>			
<b>Total weight</b>	<b>31</b>				

## Declaration of Material Contents SOD-80 Q Package

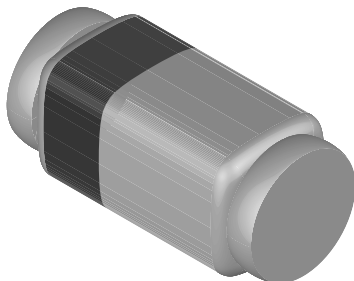

quadromelf

QuadromELF Diode

Prohibited Substances		
Material	Limit ppm	ICP Analysis < ppm
Cadmium	5	5
Asbestos	0	0
Mercury	0	0
Chromium VI	2	0
Polychl. Biphenyle	0	0
Formaldehyde	0	0
Azo Compounds	0	0

MATERIAL CONTENT					
Part	Material	weight mg	% of weight	ppm of total weight	CAS N°
Leads Tinned 53.50 %	Fe	11.02	61.39 %	327965	7439-89-6
	Cu	4.85	27.02 %	144341	7440-50-8
	Ni	1.55	8.64 %	46129	7440-02-0
	Sn	0.48	2.67 %	14285	7440-31-5
	CuO	0.05	0.28 %	1488	1317-38-0
	<b>TOTAL</b>	<b>17.95</b>			
Package Glass 46.20 %	PbO	9.79	62.96 %	291360	1317-36-8
	SiO <sub>2</sub>	4.25	27.33 %	126484	14808-60-7
	K <sub>2</sub> O	1.2	7.72 %	35713	12136-45-7
	Na <sub>2</sub> O	0.11	0.71 %	3274	1313-59-3
	Al <sub>2</sub> O <sub>3</sub>	0.11	0.71 %	3274	1344-28-1
	BaO	0.09	0.58 %	2678	1304-28-5
<b>TOTAL</b>	<b>15.55</b>				
Silicon Chip 0.30 %	Si	0.0811	80.22 %	2414	7440-21-3
	Ag	0.0168	16.62 %	500	7440-22-4
	SiO <sub>2</sub>	0.0016	1.58 %	48	14808-60-7
	PbO	0.0014	1.38 %	42	1317-36-8
	Ni	0.0002	0.20 %	6	7440-02-0
	<b>TOTAL</b>	<b>0.101</b>			
<b>Total weight</b>	<b>34</b>				

**Declaration of Material Contents MicroMELF Package**

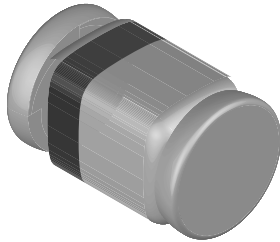

micromelf

MicroMELF Diode

Prohibited Substances		
Material	Limit ppm	ICP Analysis < ppm
Cadmium	5	5
Asbestos	0	0
Mercury	0	0
Chromium VI	2	0
Polychl. Biphenyle	0	0
Formaldehyde	0	0
Azo Compounds	0	0

MATERIAL CONTENT					
Part	Material	weight mg	% of weight	ppm of total weight	CAS N°
<b>Leads Tinned</b> 57.70 %	Fe	4.39	62.01 %	357716	7439-89-6
	Cu	1.97	27.82 %	160524	7440-50-8
	Ni	0.62	8.76 %	50520	7440-02-0
	Sn	0.09	1.27 %	7334	7440-31-5
	CuO	0.01	0.14 %	815	1317-38-0
	<b>TOTAL</b>	<b>7.08</b>			
<b>Package Glass</b> 41.50 %	PbO	3.21	62.94 %	261565	1317-36-8
	SiO <sub>2</sub>	1.39	27.25 %	113263	14808-60-7
	K <sub>2</sub> O	0.39	7.65 %	31779	12136-45-7
	Na <sub>2</sub> O	0.04	0.78 %	3259	1313-59-3
	Al <sub>2</sub> O <sub>3</sub>	0.04	0.78 %	3259	1344-28-1
	BaO	0.03	0.59 %	2445	1304-28-5
	<b>TOTAL</b>	<b>5.1</b>			
<b>Silicon Chip</b> 0.80 %	Si	0.074	80.17 %	6030	7440-21-3
	Ag	0.0153	16.58 %	1247	7440-22-4
	SiO <sub>2</sub>	0.0015	1.63 %	122	14808-60-7
	PbO	0.0013	1.41 %	106	1317-36-8
	Ni	0.0002	0.22 %	16	7440-02-0
	<b>TOTAL</b>	<b>0.0923</b>			
<b>Total weight</b>		<b>12.3</b>			

## Vishay Semiconductors

### Declaration of Material Contents DO-35 Package

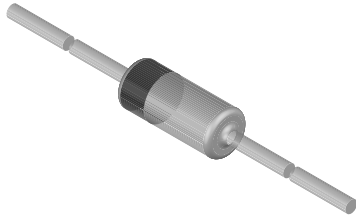

DO-35 Diode

do35

Prohibited Substances		
Material	Limit ppm	ICP Analysis < ppm
Cadmium	5	5
Asbestos	0	0
Mercury	0	0
Chromium VI	2	0
Polychl. Biphenyle	0	0
Formaldehyde	0	0
Azo Compounds	0	0

MATERIAL CONTENT					
Part	Material	weight mg	% of weight	ppm of total weight	CAS N°
Leads tinned 85.70 %	Fe	67.17	62.74 %	537037	7439-89-6
	Cu	29.78	27.82 %	238097	7440-50-8
	Ni	9.43	8.81 %	75395	7440-02-0
	Sn	0.57	0.53 %	4557	7440-31-5
	CuO	0.11	0.10 %	879	1317-38-0
	<b>TOTAL</b>	<b>107.1</b>			
Package glass 14.30 %	PbO	11.24	62.83 %	89866	1317-36-8
	SiO <sub>2</sub>	4.9	27.39 %	39176	14808-60-7
	K <sub>2</sub> O	1.38	7.71 %	11033	12136-45-7
	Na <sub>2</sub> O	0.13	0.73 %	1039	1313-59-3
	Al <sub>2</sub> O <sub>3</sub>	0.13	0.73 %	1039	1344-28-1
	BaO	0.11	0.61 %	879	1304-28-5
	<b>TOTAL</b>	<b>17.9</b>			
Silicon chip 0.10 %	Si	0.1003	80.11 %	802	7440-21-3
	Ag	0.0208	16.60 %	166	7440-22-4
	SiO <sub>2</sub>	0.002	1.60 %	16	14808-60-7
	PbO	0.0018	1.40 %	14	1317-36-8
	Ni	0.0003	0.20 %	2	7440-02-0
	<b>TOTAL</b>	<b>0.125</b>			
<b>Total weight</b>		<b>125</b>			

### Declaration of Material Contents DO-41 Package

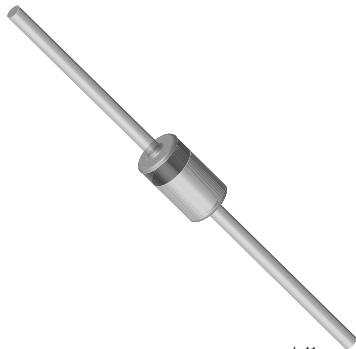

DO-41 Diode

do41

Prohibited Substances		
Material	Limit ppm	ICP Analysis < ppm
Cadmium	5	5
Asbestos	0	0
Mercury	0	0
Chromium VI	2	0
Polychl. Biphenyle	0	0
Formaldehyde	0	0
Azo Compounds	0	0

MATERIAL CONTENT					
Part	Material	weight mg	% of weight	ppm of total weight	CAS N°
Leads tinned 85.70 %	Fe	166.58	62.75 %	537147	7439-89-6
	Cu	73.86	27.82 %	238166	7440-50-8
	Ni	23.38	8.81 %	75390	7440-02-0
	Sn	1.39	0.52 %	4482	7440-31-5
	CuO	0.27	0.10 %	871	1317-38-0
	<b>TOTAL</b>	<b>265.48</b>			
Package glass 14.30 %	PbO	27.88	62.89 %	89901	1317-36-8
	SiO <sub>2</sub>	12.15	27.41 %	39178	14808-60-7
	K <sub>2</sub> O	3.41	7.69 %	10996	12136-45-7
	Na <sub>2</sub> O	0.31	0.70 %	1000	1313-59-3
	Al <sub>2</sub> O <sub>3</sub>	0.31	0.70 %	1000	1344-28-1
	BaO	0.27	0.61 %	871	1304-28-5
	<b>TOTAL</b>	<b>44.33</b>			
Silicon chip 0.10 %	Si	0.2523	81.41 %	814	7440-21-3
	Ag	0.0474	15.30 %	153	7440-22-4
	SiO <sub>2</sub>	0.0053	1.71 %	17	14808-60-7
	PbO	0.0043	1.39 %	14	1317-36-8
	Ni	0.0006	0.19 %	2	7440-02-0
	<b>TOTAL</b>	<b>0.3099</b>			
<b>Total weight</b>		<b>310.1199</b>			

Declaration of Material Contents DO-41 Plastic Package

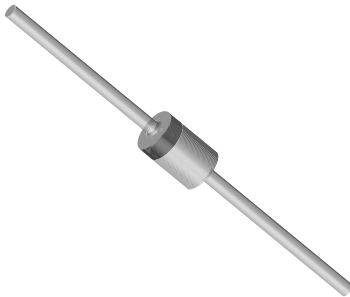

do204am

DO-41 Plastic Diode

Prohibited Substances		
Material	Limit ppm	ICP Analysis < ppm
Cadmium	5	5
Asbestos	0	0
Mercury	0	0
Chromium VI	2	0
Polychl. Biphenyle	0	0
Formaldehyde	0	0
Azo Compounds	0	0

MATERIAL CONTENT					
Part	Material	weight mg	% of weight	ppm of total weight	CAS N°
Leads tinned 85.6 %	Cu	283.8	96.3 %	825000	7440-50-7
	Sn	10.8	3.7 %	31395	7439-92-1
	<b>TOTAL</b>	<b>294.6</b>			
Solder pellet 0.5 %	Pb	1.57	92.4 %	4564	7440-31-5
	Sn	0.09	5.3 %	262	7439-92-1
	Ag	0.04	2.4 %	116	7440-22-4
	<b>TOTAL</b>	<b>1.7</b>			
Chip 0.3 %	Si	0.896	0.3 %	2605	7440-21-3
	SiO <sub>2</sub>	0.004	0.0 %	12	14808-60-7
	And / or traces of Au, As, Ag, Ti, Al, Ni, Pd, Cu				
	<b>TOTAL</b>	<b>0.9</b>			
Coating 0.3 %	Elastomer	1.2	100.0 %	3488	
	<b>TOTAL</b>	<b>1.2</b>			
Molding (Epoxy) 13.3 %	Silica, vitreous	32.457	11.0 %	94352	60676-86-0
	Epikote 862	9.12	3.1 %	26512	28064-14-4
	Phenolic resin	3.42	1.2 %	9942	9003-35-4
	Antimony oxide	0.364	0.1 %	1058	1309-64-4
	Carbon black	0.137	0.0 %	398	1333-86-4
	Cristobalite	0.102	0.0 %	297	14464-46-1
	Arsenic	Trace			7440-38-2
	Lead	Trace			7439-92-1
	<b>TOTAL</b>	<b>45.6</b>			
	<b>Total weight</b>	<b>344</b>			

# Vishay Semiconductors

## Declaration of Material Contents SOD-57 Package

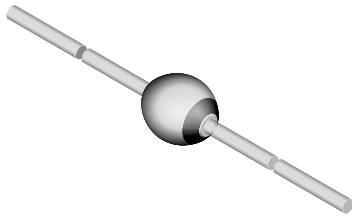

sod57

SOD-57 Diode

Prohibited Substances		
Material	Limit ppm	ICP Analysis < ppm
Cadmium	5	5
Asbestos	0	0
Mercury	0	0
Chromium VI	2	0
Polychl. Biphenyle	0	0
Formaldehyde	0	0
Azo Compounds	0	0

MATERIAL CONTENT					
Part	Material	weight mg	% of weight	ppm of total weight	CAS N°
Leads tinned 85.90 %	Cu	184.98	58.36 %	501111	7440-50-8
	Fe	70.24	22.16 %	190280	7439-89-6
	Mo	58.8	18.55 %	159289	7439-98-7
	Sn	1.99	0.63 %	5391	7440-31-5
	Ag	0.32	0.10 %	867	7440-22-4
	C	0.32	0.10 %	867	7440-44-0
	O <sub>2</sub>	0.32	0.10 %	867	7782-44-7
	<b>TOTAL</b>	<b>316.97</b>			
Package glass 13.80 %	PbO	21.45	42.01 %	58108	1317-36-8
	SiO <sub>2</sub>	19.4	37.99 %	52555	14808-60-7
	B <sub>2</sub> O <sub>3</sub>	7.66	15.00 %	20751	1303-86-2
	Al <sub>2</sub> O <sub>3</sub>	2.55	4.99 %	6908	1344-28-1
	<b>TOTAL</b>	<b>51.06</b>			
Silicon chip 0.30 %	Si	0.999	90.00 %	2706	7440-21-3
	Al	0.111	10.00 %	301	7429-90-5
	<b>TOTAL</b>	<b>1.11</b>			
<b>Total weight</b>		<b>369.14</b>			

## Declaration of Material Contents SOD-64 Package

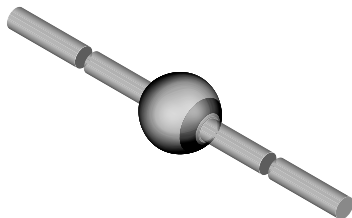

sod64

SOD-64 Diode

Prohibited Substances		
Material	Limit ppm	ICP Analysis < ppm
Cadmium	5	5
Asbestos	0	0
Mercury	0	0
Chromium VI	2	0
Polychl. Biphenyle	0	0
Formaldehyde	0	0
Azo Compounds	0	0

MATERIAL CONTENT					
Part	Material	weight mg	% of weight	ppm of total weight	CAS N°
Leads tinned 85.90 %	Cu	429.95	58.35 %	501078	7440-50-8
	Fe	163.26	22.16 %	190269	7439-89-6
	Mo	136.67	18.55 %	159280	7439-98-7
	Sn	4.69	0.64 %	5466	7440-31-5
	Ag	0.74	0.10 %	862	7440-22-4
	C	0.74	0.10 %	862	7440-44-0
	O <sub>2</sub>	0.74	0.10 %	862	7782-44-7
	<b>TOTAL</b>	<b>736.79</b>			
Package glass 13.80 %	PbO	49.85	42.00 %	58097	1317-36-8
	SiO <sub>2</sub>	45.1	38.00 %	52561	14808-60-7
	B <sub>2</sub> O <sub>3</sub>	17.8	15.00 %	20745	1303-86-2
	Al <sub>2</sub> O <sub>3</sub>	5.93	5.00 %	6911	1344-28-1
	<b>TOTAL</b>	<b>118.68</b>			
Silicon chip 0.30 %	Si	2.322	90.00 %	2706	7440-21-3
	Al	0.258	10.00 %	301	7429-90-5
	And / or traces of Mo, P, Ga, Pt				
	<b>TOTAL</b>	<b>2.58</b>			
<b>Total weight</b>		<b>858</b>			

Declaration of Material Contents SMF (DO-219AB) Package

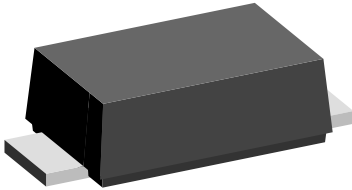

SMF Diode

smf

Prohibited Substances		
Material	Limit ppm	ICP Analysis < ppm
Cadmium	5	5
Asbestos	0	0
Mercury	0	0
Chromium VI	2	0
Polychl. Biphenyle	0	0
Formaldehyde	0	0
Azo Compounds	0	0

MATERIAL CONTENT						
Part	Material	weight mg	% of weight	ppm of total weight	CAS N°	
Lead frame tinned 44.3 %	Cu	6.198	94.34 %	418311	7440-50-8	
	Fe	0.153	2.32 %	10302	7439-89-6	
	Zn	0.008	0.12 %	515	7440-66-6	
	P	0.002	0.03 %	129	7723-14-0	
	Sn	0.210	3.20 %	14174	7440-31-5	
	<b>TOTAL</b>	<b>6.57</b>				
Solder paste (chip solder) 1.1 %	Pb	0.142	90.85 %	9584	7439-92-1	
	Sn	0.005	3.07 %	324	7440-31-5	
	Ag	0.003	2.11 %	223	7440-22-4	
	Hexylene-glyco	0.006	3.97 %	418	107-41-5	
	<b>TOTAL</b>	<b>0.16</b>				
Silicon chip 3.2 %	Si	0.468	99.57 %	31587	7440-21-3	
	Silicon dioxide	0.002	0.43 %	135	14808-60-7	
	And/or traces of Au,As,Ti,Ag,Al, Ni, Pd, Cu					
<b>TOTAL</b>	<b>0.47</b>					
Molding compound 51.4 %	Cristalline Silica	5.258	69.00 %	354866	14808-60-7	
	Polyglycidyl ether	1.143	15.00 %	77145	29690-82-2	
	Phenolic resin	0.533	7.00 %	36001	9003-35-4	
	Brominated epoxy resin	0.229	3.00 %	15429	40039-93-8	
	Organo functional silan	0.076	1.00 %	5143	2530-83-8	
	Antimony trioxid	0.229	3.00 %	15429	1309-64-4	
	Wax	0.076	1.00 %	5143	8015-86-9	
	Catalyst	0.076	1.00 %	5143	603-35-0	
	<b>TOTAL</b>	<b>7.62</b>				
	<b>Total weight</b>	<b>14.8</b>				



Declaration of Material Contents SOT-23 Package

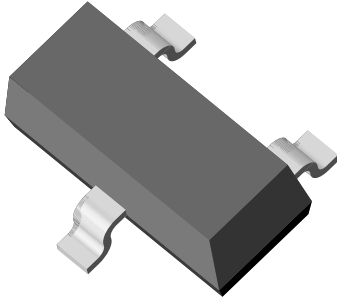

SOT-23 Diode

Prohibited Substances		
Material	Limit ppm	ICP Analysis < ppm
Cadmium	5	5
Asbestos	0	0
Mercury	0	0
Chromium VI	2	0
Polychl. Biphenyle	0	0
Formaldehyde	0	0
Azo Compounds	0	0

MATERIAL CONTENT					
Part	Material	weight mg	% of weight	ppm of total weight	CAS N°
Lead frame tinned 31.9 %	Cu	2.7	96.2 %	306954	7440-50-8
	Sn	0.02	0.7 %	2274	7440-31-5
	Ni	0.01	0.4 %	1137	7440-02-0
	Cr	0.008	0.3 %	909	7440-47-3
	Ti	0.008	0.3 %	909	7440-32-6
	Sn	0.06	2.1 %	6821	7440-31-5
	<b>TOTAL</b>	<b>2.81</b>			
Moulding (PPS, Polyphenylene Sulfide) 61.4 %	Mineral reinforcement	2.97	55.00 %	337650	
	1.4- Dichlorobenzene	0.00054	0.01 %	61	25321-22-6
	Other + Carbon black + Silicon dioxide	2.43	44.99 %	276197	1333-86-4 + 14808-60-7
	<b>TOTAL</b>	<b>5.4</b>			
Glue 0.7 %	Silver powder	0.04215	70.3 %	4792	7440-22-4
	Hardener and epoxy resin	0.01785	29.8 %	2029	
	<b>TOTAL</b>	<b>0.06</b>			
Chip 1.1 %	Si	0.0996	99.60 %	11323	7440-21-3
	SiO <sub>2</sub>	0.0004	0.40 %	45	14808-60-7
	And / or traces of Au, As, Ag, Ti, Al, Ni, Pd, Cu				
	<b>TOTAL</b>	<b>0.1</b>			
Bond wire 0.3 %	Au	0.03	100 %	3411	7440-57-5
	<b>TOTAL</b>	<b>0.03</b>			
Bond wire coating (Epoxy resin) 4.5 %	Benzophenonetetra carboxylic acid dianhydride	0.12	30.0 %	13642	2421-28-5
	Quartz	0.002	0.5 %	227	14808-60-7
	Cristobalite	0.0012	0.3 %	136	14464-46-1
	Silica	0.12	30.0 %	13642	60676-86-0
	Carbon black	0.004	1.0 %	455	1333-86-4
	Epichlorohydrin	0.00002	0.005 %	2	106-89-8
	Other (harmless addition)	0.15288	38.2 %	17380	
	<b>TOTAL</b>	<b>0.40</b>			
<b>Total weight</b>		<b>8.8</b>			

Declaration of Material Contents SOD-123 Package

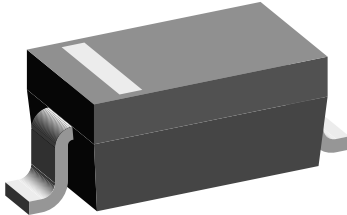

sod123

SOD-123 Diode

Prohibited Substances		
Material	Limit ppm	ICP Analysis < ppm
Cadmium	5	5
Asbestos	0	0
Mercury	0	0
Chromium VI	2	0
Polychl. Biphenyle	0	0
Formaldehyde	0	0
Azo Compounds	0	0

MATERIAL CONTENT					
Part	Material	weight mg	% of weight	ppm of total weight	CAS N°
Lead frame tinned 29.4 %	Cu	2.6	95.7 %	280869	7440-50-8
	Sn	0.015	0.6 %	1620	7440-31-5
	Ni	0.01	0.4 %	1080	7440-02-0
	Cr	0.007	0.3 %	756	7440-47-3
	Ti	0.007	0.3 %	756	7440-32-6
	Sn	0.078	2.9 %	8426	7440-31-5
	<b>TOTAL</b>		<b>2.72</b>		
Moulding (PPS, Polyphenylene Sulfide) 64.8 %	Mineral reinforcement	3.3	55.00 %	356487	
	1.4- Dichlorobenzene	0.0006	0.01 %	65	25321-22-6
	Other + Carbon black + Silicon dioxide	2.6994	44.99 %	291606	1333-86-4 + 14808-60-7
	<b>TOTAL</b>		<b>6</b>		
Glue 0.6 %	Silver powder	0.04215	70.3 %	4553	7440-22-4
	Hardener and epoxy resin	0.01785	29.8 %	1928	
	<b>TOTAL</b>		<b>0.06</b>		
Chip 0.9 %	Si	0.07968	99.60 %	8608	7440-21-3
	SiO2	0.00032	0.40 %	35	14808-60-7
	And / or traces of Au, As, Ag, Ti, Al, Ni, Pd, Cu				
	<b>TOTAL</b>		<b>0.08</b>		
Bond wire 0.3 %	Au	0.03	100 %	3241	7440-57-5
	<b>TOTAL</b>		<b>0.03</b>		
Bond wire coating (Epoxy resin) 4.0 %	Benzophenonetetra carboxylic acid dianhydride	0.12	32.4 %	12963	2421-28-5
	Quartz	0.002	0.5 %	216	14808-60-7
	Cristobalite	0.0012	0.3 %	130	14464-46-1
	Silica	0.12	32.4 %	12963	60676-86-0
	Carbon black	0.004	1.1 %	432	1333-86-4
	Epichlorohydrin	0.00002	0.005 %	2	106-89-8
	Other (harmless addition)	0.12278	33.2 %	13263	
<b>TOTAL</b>		<b>0.37</b>			
<b>Total weight</b>		<b>9.3</b>			

Declaration of Material Contents SOD-323 Package

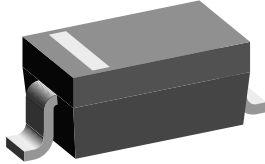

sod323

SOD-323 Diode

Prohibited Substances		
Material	Limit ppm	ICP Analysis < ppm
Cadmium	5	5
Asbestos	0	0
Mercury	0	0
Chromium VI	2	0
Polychl. Biphenyle	0	0
Formaldehyde	0	0
Azo Compounds	0	0

MATERIAL CONTENT					
Part	Material	weight mg	% of weight	ppm of total weight	CAS N°
Lead frame tinned 26.9 %	Cu	1.28	95.5%	256977	7440-50-8
	Sn	0.008	0.6%	1606	7440-31-5
	Ni	0.005	0.4%	1004	7440-02-0
	Cr	0.004	0.3%	803	7440-47-3
	Ti	0.004	0.3%	803	7440-32-6
	Sn	0.04	3.0%	8031	7440-31-5
	<b>TOTAL</b>	<b>1.34</b>			
Moulding (PPS, Polyphenylene Sulfide) 62.2 %	Mineral reinforcement	1.705	55.00%	342301	
	1.4-Dichlorobenzene	0.00031	0.01%	62	25321-22-6
	Other + Carbon black + Silicon dioxide	1.39	44.99%	280002	1333-86-4 + 14808-60-7
	<b>TOTAL</b>	<b>3.1</b>			
Glue 1.2 %	Silver powder	0.04215	70.3%	8462	7440-22-4
	Hardener and epoxyresin	0.01785	29.8%	3584	
	<b>TOTAL</b>	<b>0.06</b>			
Chip 1.6 %	Si	0.07968	99.60%	15997	7440-21-3
	SiO2	0.00032	0.40%	64	14808-60-7
	And / or traces of Au, As, Ag, Ti, Al, Ni, Pd, Cu				
	<b>TOTAL</b>	<b>0.08</b>			
Bond wire 0.6 %	Au	0.03	100%	6023	7440-57-5
	<b>TOTAL</b>	<b>0.03</b>			
Bond wire coating (Epoxy resin) 7.4 %	Benzophenonetetra carboxylic acid dianhydride	0.12	32.4%	24092	2421-28-5
	Quartz	0.002	0.5%	402	14808-60-7
	Cristobalite	0.0012	0.3%	241	14464-46-1
	Silica	0.12	32.4%	24092	60676-86-0
	Carbon black	0.004	1.1%	803	1333-86-4
	Epichlorohydrin	0.00002	0.005%	4	106-89-8
	Other (harmless addition)	0.12278	33.2%	24650	
	<b>TOTAL</b>	<b>0.37</b>			
<b>Total weight</b>		<b>5.0</b>			

Declaration of Material Contents SOD-523 Package

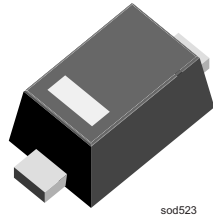

sod523

SOD-523 Diode

Prohibited Substances		
Material	Limit ppm	ICP Analysis < ppm
Cadmium	5	5
Asbestos	0	0
Mercury	0	0
Chromium VI	2	0
Polychl. Biphenyle	0	0
Formaldehyde	0	0
Azo Compounds	0	0

MATERIAL CONTENT					
Part	Material	weight mg	% of weight	ppm of total weight	CAS N°
Mold compound 53.2 %	SiO <sub>2</sub>	0.65	77.0 %	409882	14808-60-7
	epoxy resin	0.17	20.0 %	106463	25928-94-3
	Sb <sub>2</sub> O <sub>3</sub>	0.026	3.0 %	15969	1309-64-4
	<b>TOTAL</b>	<b>0.85</b>			
Lead frame tinned 43.6 %	Cu	0.627	90.10 %	392660	7440-50-8
	Ag	0.015	2.16 %	9394	7440-22-4
	Sn	0.053	7.62 %	33191	7440-31-5
	Si	0.0001	0.01 %	63	7440-21-3
	Cr	0.000	0.03 %	125	7440-47-3
	Ti	0.001	0.09 %	376	7440-32-6
<b>TOTAL</b>	<b>0.696</b>				
Silicon chip 2.4 %	Si	0.034	89.71 %	21293	7440-21-3
	Au	0.0035	9.23 %	2192	7440-57-5
	SiO <sub>2</sub>	0.0002	0.53 %	125	14808-60-7
	Al	0.0002	0.53 %	125	7429-90-5
	And / or traces of Au, As, B, P, Pd, Sn, Ti, V, W				
<b>TOTAL</b>	<b>0.038</b>				
Bond wire 0.8 %	Au	0.013	100.0 %	8141	7440-57-5
	<b>TOTAL</b>	<b>0.013</b>			
<b>Total weight</b>		<b>1.60</b>			

Declaration of Material Contents SOT-363 Package

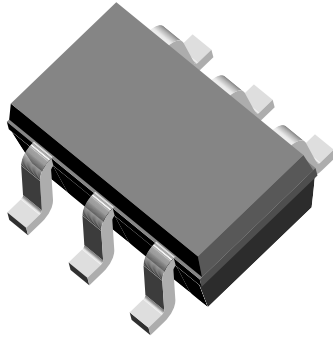

SOT-363 Diode

Prohibited Substances		
Material	Limit ppm	ICP Analysis < ppm
Cadmium	5	5
Asbestos	0	0
Mercury	0	0
Chromium VI	2	0
Polychl. Biphenyle	0	0
Formaldehyde	0	0
Azo Compounds	0	0

MATERIAL CONTENT					
Part	Material	weight mg	% of weight	ppm of total weight	CAS N°
<b>Mold compound</b> 57.10 %	SiO <sub>2</sub>	2.45	71.64 %	408401	14808-60-7
	epoxy resin	0.89	26.02 %	148358	25925-94-3
	Sb <sub>2</sub> O <sub>3</sub>	0.05	1.46 %	8335	1309-64-4
	Br	0.03	0.88 %	5001	7726-95-6
	<b>TOTAL</b>	<b>3.42</b>			
<b>Lead frame tinned</b> 38.70 %	Cu	1.98	85.09 %	330055	7440-50-8
	Ag	0.23	9.88 %	38340	7440-22-4
	Sn	0.077	3.31 %	12835	7440-31.5
	Ni	0.02	0.86 %	3334	7440-02-0
	Cr	0.01	0.43 %	1667	7440-47-3
	Ti	0.01	0.43 %	1667	7440-32-6
<b>TOTAL</b>	<b>2.33</b>				
<b>Silicon chip</b> 3.90 %	Si	0.2188	93.50 %	36473	7440-21-3
	Au	0.0122	5.21 %	2034	7440-57-5
	SiO <sub>2</sub>	0.0012	0.51 %	200	14808-60-7
	Al	0.0009	0.38 %	150	7429-90-5
	Si <sub>3</sub> N <sub>4</sub>	0.0009	0.38 %	150	12033-89-5
<b>TOTAL</b>	<b>0.23</b>				
<b>Bond wire 0.3 %</b>	Au	0.018	100.0 %	3001	7440-57-5
	<b>TOTAL</b>	<b>0.02</b>	99.90 %		
<b>Total weight</b>		<b>6</b>			

Declaration of Material Contents LLP-75 Package

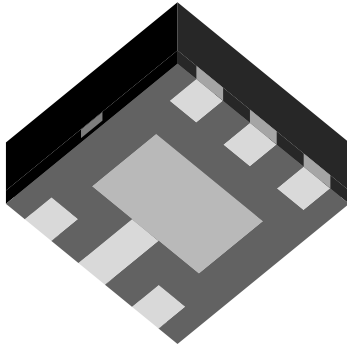

LLP-75 Diode

Prohibited Substances		
Material	Limit ppm	ICP Analysis < ppm
Cadmium	5	5
Asbestos	0	0
Mercury	0	0
Chromium VI	2	0
Polychl. Biphenyle	0	0
Formaldehyde	0	0
Azo Compounds	0	0

MATERIAL CONTENT					
Part	Material	weight mg	% of weight	ppm of total weight	CAS N°
Lead frame tinned 27.8 %	Cu	1.34	93.7 %	260189	7440-50-8
	Sn	0.003	0.2 %	660	7440-31-5
	Zn	0.003	0.2 %	583	7440-66-6
	Cr	0.003	0.2 %	660	7440-47-3
	Sn (plating)	0.08	5.6 %	15534	7440-31-5
	<b>TOTAL</b>	<b>1.43</b>			
Moulding 63.3 %	Amorphous silica	2.608	79.99 %	506398	7631-86-3
	Others	0.463	14.20 %	89901	
	Epoxy resin	0.16	5.00 %	31650	25928-94-3
	Antimony trioxide	0.016	0.50 %	3165	1309-64-4
	Carbon black	0.01	0.31 %	1942	1333-86-3
	<b>TOTAL</b>	<b>3.2603</b>			
Glue 1.7 %	Silver powde	0.063	70.2 %	12272	7440-22-4
	Hardener and epoxy resin	0.027	29.8 %	5204	
	<b>TOTAL</b>	<b>0.09</b>			
Chip 5.8 %	Si	0.299	99.60 %	58018	7440-21-3
	SiO <sub>2</sub>	0.001	0.40 %	233	14808-60-7
	And / or traces of Au, As, Ag, Ti, Al, Ni, Pd, Cu				
<b>TOTAL</b>	<b>0.3</b>				
Bond wire 1.4 %	Au	0.07	100 %	13592	7440-57-5
	<b>TOTAL</b>	<b>0.07</b>			
<b>Total weight</b>		<b>5.2</b>			



# Marking of Diodes

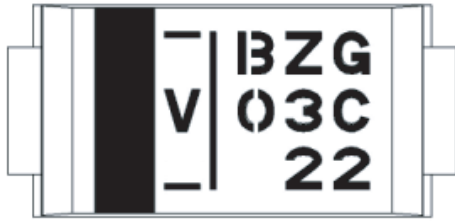

18583

Figure 1. DO-214

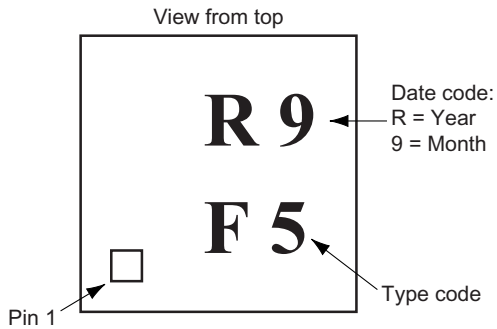

18904

Figure 2. LLP75-6A

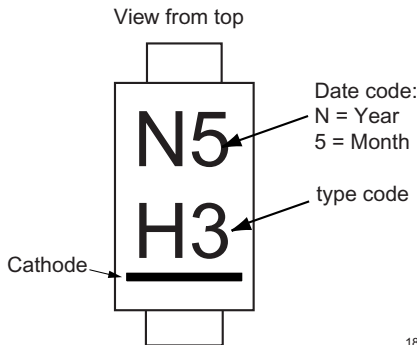

18918

Figure 3. SMF (DO-219AB)

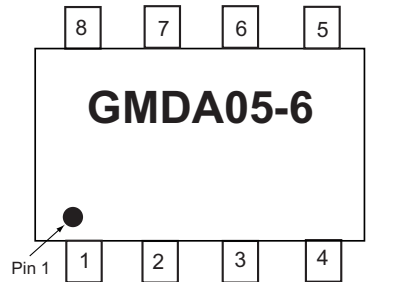

18954

Figure 4. SO-8

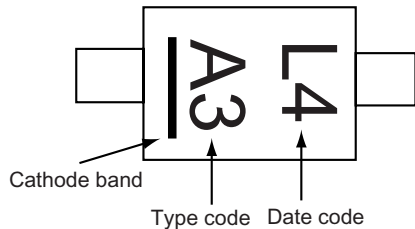

18920

Figure 5. SOD-123

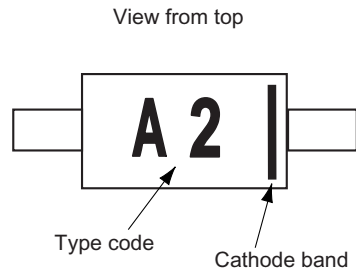

18919

Figure 6. SOD-323



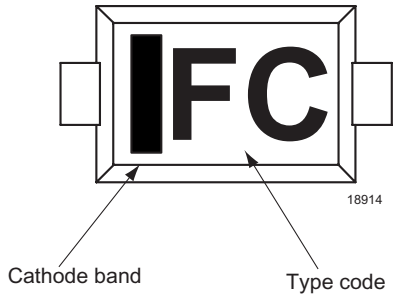

Figure 7. SOD-523

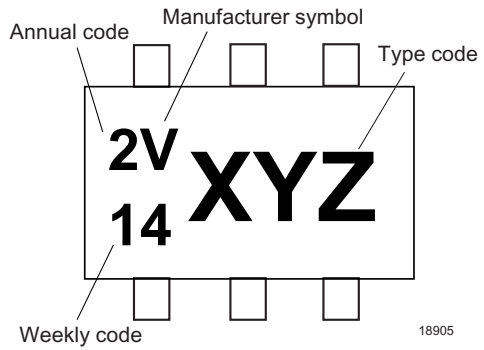

Figure 10. SOT-363

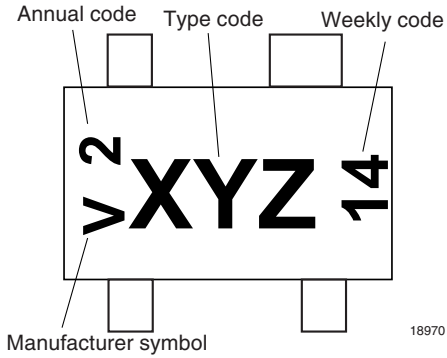

Figure 8. SOT-143

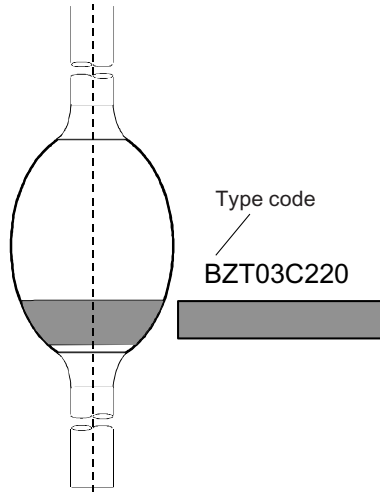

Figure 11. SOD-57

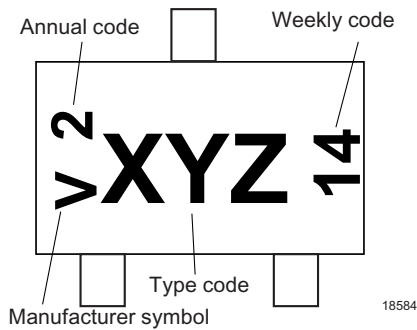
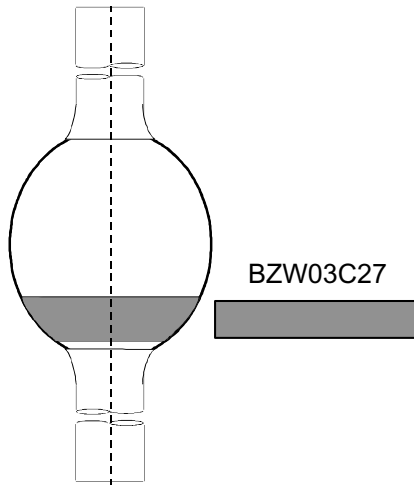
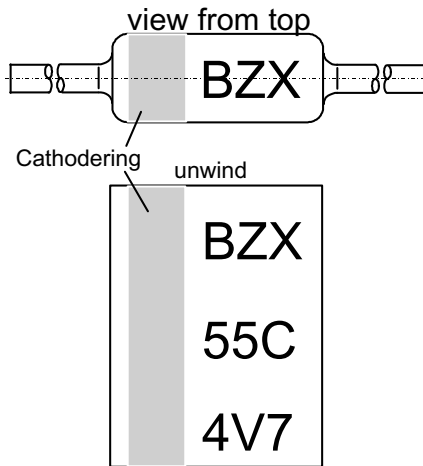

Figure 9. SOT-23



18582

Figure 12. SOD-64



18572

Figure 13. DO-35

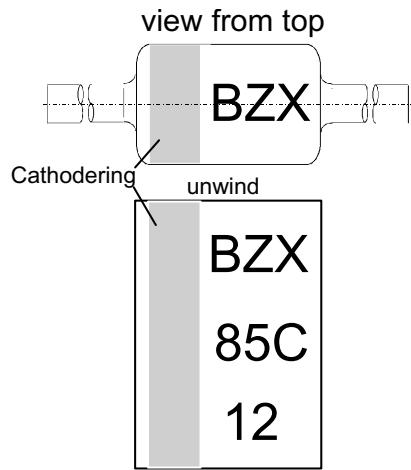

18576

Figure 14. DO-41

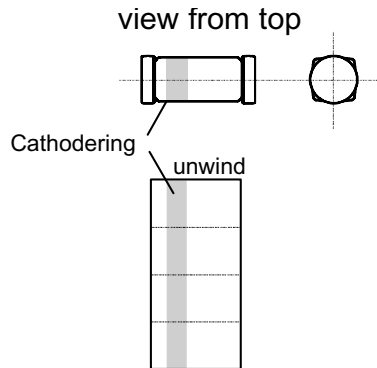

18580

Figure 15. MicroMELF  
Label with information of TYPE on reel and package

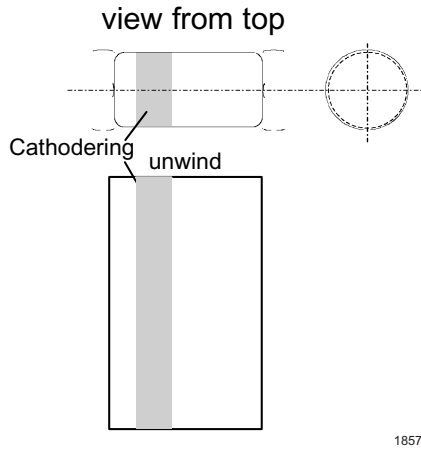

Figure 16. SOD-80 MiniMELF  
Label with information of TYPE on reel and package

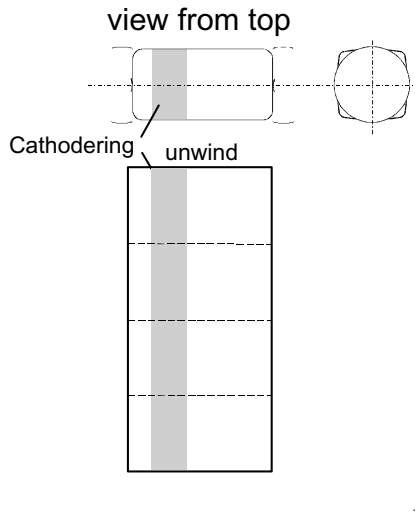

Figure 17. SOD-80 QuadroMELF  
Label with information of TYPE on reel and package

Selector Guides



General Information



**Zener Datasheets**

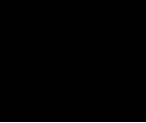

ESD Datasheets



Packages



Application Notes



Glossary





## Small Signal Zener Diodes

### Features

- Zener voltage specified at 50  $\mu$ A
- Maximum delta  $V_Z$  given from 10  $\mu$ A to 100  $\mu$ A
- Very high stability
- Low noise



94 9367

### Applications

Voltage stabilization

### Mechanical Data

**Case:** DO-35 Glass case

**Weight:** approx. 125 mg

**Packaging codes/options:**

TR / 10 k per 13 " reel, 30 k/box

TAP / 10 k per Ammo tape (52 mm tape), 30 k/box

### Absolute Maximum Ratings

$T_{amb} = 25\text{ }^{\circ}\text{C}$ , unless otherwise specified

Parameter	Test condition	Symbol	Value	Unit
Power dissipation	$I = 4\text{ mm}$	$P_{tot}$	500	mW
Z-current		$I_Z$	$P_{tot}/V_Z$	mA

### Thermal Characteristics

$T_{amb} = 25\text{ }^{\circ}\text{C}$ , unless otherwise specified

Parameter	Test condition	Symbol	Value	Unit
Junction temperature		$T_j$	175	$^{\circ}\text{C}$
Storage temperature range		$T_{stg}$	- 65 to + 175	$^{\circ}\text{C}$
Junction ambient	$I = 4\text{ mm}, T_L = \text{constant}$	$R_{thJA}$	300	K/W

### Electrical Characteristics

$T_{amb} = 25\text{ }^{\circ}\text{C}$ , unless otherwise specified

Parameter	Test condition	Symbol	Min	Typ.	Max	Unit
Forward voltage	$I_F = 100\text{ mA}$	$V_F$			1.5	V



### Electrical Characteristics

Partnumber <sup>1)</sup>	Zener Voltage			Max.Reverse Current	Test Voltage	Max. Zener Current	Max. Voltage Change
	$V_Z @ I_Z = 50 \mu\text{s}$			$I_R$ <sup>3)</sup>	$V_R$ <sup>3)</sup>	$I_{ZM}$ <sup>2)</sup>	$\Delta V_Z$ <sup>4)</sup>
	V			$\mu\text{A}$	V	mA	V
	typ. <sup>1)</sup>	min.	max				
1N4678	1.8	1.71	1.89	7.5	1	120	0.70
1N4679	2	1.9	2.1	5	1	110	0.70
1N4680	2.2	2.09	2.31	4	1	100	0.75
1N4681	2.4	2.28	2.52	2	1	95	0.80
1N4682	2.7	2.565	2.835	1	1	90	0.85
1N4683	3	2.85	3.15	0.8	1	85	0.90
1N4684	3.3	3.135	3.465	7.5	1.5	80	0.95
1N4685	3.6	3.42	3.78	7.5	2	75	0.95
1N4686	3.9	3.705	4.095	5	2	70	0.97
1N4687	4.3	4.085	4.515	4	2	65	0.99
1N4688	4.7	4.465	4.935	10	3	60	0.99
1N4689	5.1	4.845	5.355	10	3	55	0.97
1N4690	5.6	5.32	5.88	10	4	50	0.96
1N4691	6.2	5.89	6.51	10	5	45	0.95
1N4692	6.8	6.46	7.14	10	5.1	35	0.90
1N4693	7.5	7.125	7.875	10	5.7	31.8	0.75
1N4694	8.2	7.79	8.61	1	6.2	29	0.5
1N4695	8.7	8.265	9.135	1	6.6	27.4	0.1
1N4696	9.1	8.645	9.555	1	6.9	26.2	0.08
1N4697	10	9.5	10.5	1	7.6	24.8	0.1
1N4698	11	10.45	11.55	0.05	8.4	21.6	0.11
1N4699	12	11.4	12.6	0.05	9.1	20.4	0.12
1N4700	13	12.35	13.65	0.05	9.8	19	0.13
1N4701	14	13.3	14.7	0.05	10.6	17.5	0.14
1N4702	15	14.25	15.75	0.05	11.4	16.3	0.15
1N4703	16	15.2	16.8	0.05	12.1	15.4	0.16
1N4704	17	16.15	17.85	0.05	12.9	14.5	0.17
1N4705	18	17.1	18.9	0.05	13.6	13.2	0.18
1N4706	19	18.05	19.95	0.05	14.4	12.5	0.19
1N4707	20	19	21	0.01	15.2	11.9	0.2
1N4708	22	20.9	23.1	0.01	16.7	10.8	0.22
1N4709	24	22.8	25.2	0.01	18.2	9.9	0.24
1N4710	25	23.75	26.25	0.01	19	9.5	0.25
1N4711	27	25.65	28.35	0.01	20.4	8.8	0.27
1N4712	28	26.6	29.4	0.01	21.2	8.5	0.28
1N4713	30	28.5	31.5	0.01	22.8	7.9	0.3
1N4714	33	31.35	34.65	0.01	25	7.2	0.33
1N4715	36	34.2	37.8	0.01	27.3	6.6	0.36
1N4716	39	37.05	40.95	0.01	29.6	6.1	0.39
1N4717	43	40.85	45.15	0.01	32.6	5.5	0.43

<sup>1)</sup> Tolerancing and voltage designation ( $V_Z$ ). The type numbers shown have a standard tolerance of  $\pm 5\%$  on the nominal zener voltage.

<sup>2)</sup> Maximum zener current ratings ( $I_{ZM}$ ). Maximum zener current ratings are based on maximum zener voltage of the individual units.

<sup>3)</sup> Reverse leakage current ( $I_R$ ). Reverse leakage currents are guaranteed and measured at  $V_R$  as shown on the table.

<sup>4)</sup> Maximum voltage change ( $\Delta V_Z$ ). Voltage change is equal to the difference between  $V_Z$  at  $100 \mu\text{A}$  and  $V_Z$  at  $10 \mu\text{A}$ .

### Typical Characteristics ( $T_{amb} = 25^\circ\text{C}$ unless otherwise specified)

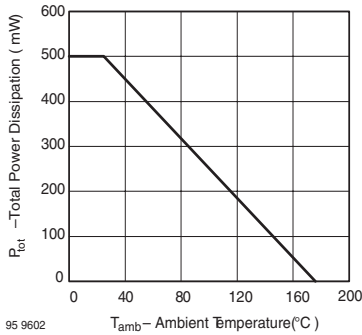

Figure 1. Total Power Dissipation vs. Ambient Temperature

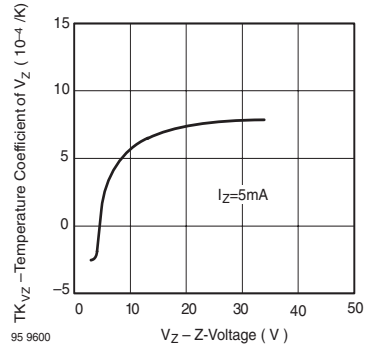

Figure 4. Temperature Coefficient of  $V_Z$  vs. Z-Voltage

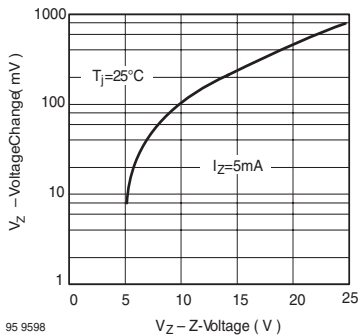

Figure 2. Typical Change of Working Voltage under Operating Conditions at  $T_{amb}=25^\circ\text{C}$

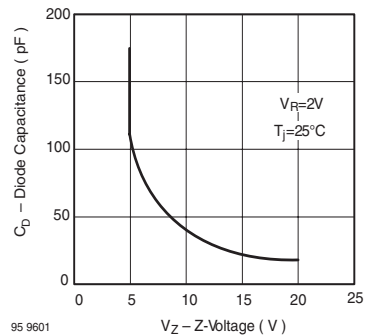

Figure 5. Diode Capacitance vs. Z-Voltage

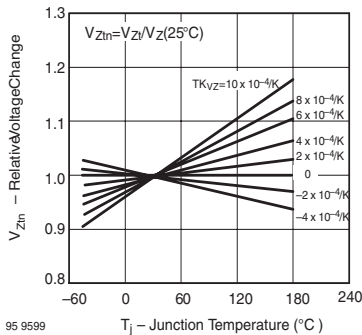

Figure 3. Typical Change of Working Voltage vs. Junction Temperature

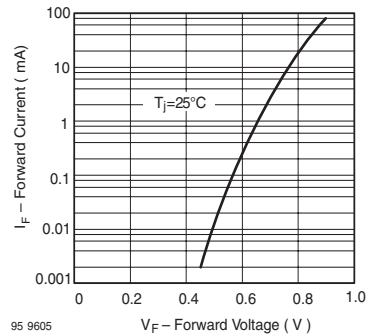

Figure 6. Forward Current vs. Forward Voltage



# 1N4678 to 1N4717

Vishay Semiconductors

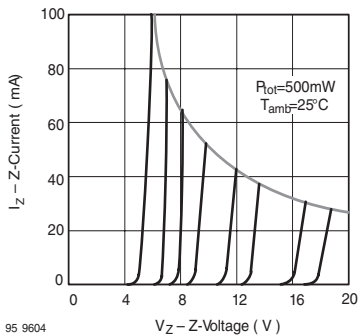

Figure 7. Z-Current vs. Z-Voltage

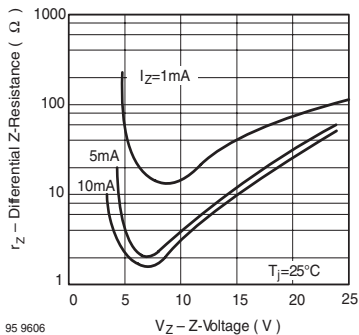

Figure 9. Differential Z-Resistance vs. Z-Voltage

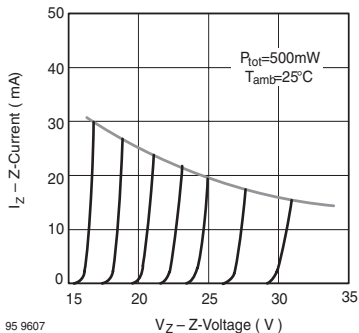

Figure 8. Z-Current vs. Z-Voltage

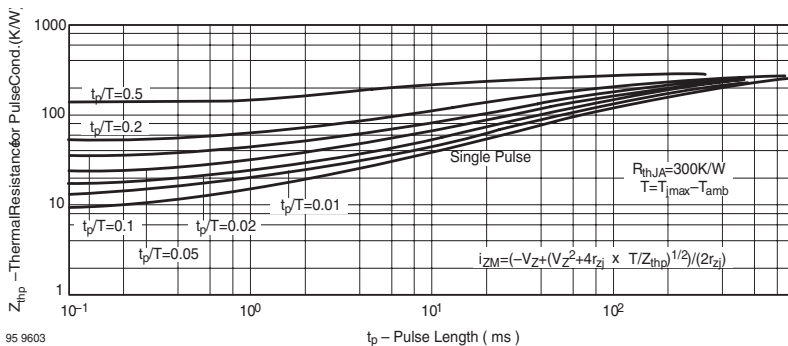

Figure 10. Thermal Response

DO-35 Package Dimension

see Package Section

## Zener Diodes

### Features

- Silicon Planar Power Zener Diodes
- For use in stabilizing and clipping circuits with high power rating.
- Standard Zener voltage tolerance is  $\pm 5\%$ .

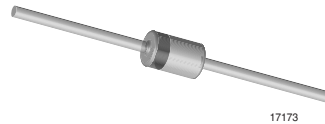

### Applications

Voltage stabilization

### Mechanical Data

**Case:** DO-41 Glass case

**Weight:** approx. 310 mg

**Packaging Codes/Options:**

TR / 5 k per 13 " reel , 25 k/box

TAP / 5 k per Ammo mag. (52 mm tape), 25 k/box

### Absolute Maximum Ratings

$T_{amb} = 25\text{ }^{\circ}\text{C}$ , unless otherwise specified

Parameter	Test condition	Symbol	Value	Unit
Power dissipation	$T_{amb} \leq 50\text{ }^{\circ}\text{C}$	$P_{tot}$	1	W
Z-current		$I_Z$	$P_V/V_Z$	mA

### Thermal Characteristics

$T_{amb} = 25\text{ }^{\circ}\text{C}$ , unless otherwise specified

Parameter	Test condition	Symbol	Value	Unit
Junction temperature		$T_j$	200	$^{\circ}\text{C}$
Storage temperature range		$T_{stg}$	- 65 to + 200	$^{\circ}\text{C}$
Junction ambient	$l = 9.5\text{ mm (3/8" )}$ , $T_L = \text{constant}$	$R_{thJA}$	100	K/W

### Electrical Characteristics

$T_{amb} = 25\text{ }^{\circ}\text{C}$ , unless otherwise specified

Parameter	Test condition	Symbol	Min	Typ.	Max	Unit
Forward voltage	$I_F = 200\text{ mA}$	$V_F$			1.2	V

# 1N4728A to 1N4764A



Vishay Semiconductors

## Electrical Characteristics

1N4728A...1N4764A

Partnumber	Nominal Zener Voltage <sup>1)</sup>	Test Current	Maximum Dynamic Impedance			Maximum Reverse Leakage Current		Surge current	Maximum Regulator Current <sup>2)</sup>	
			$I_{ZT}$	$Z_{ZT} @ I_{ZT}$	$Z_{ZK} @ I_{ZK}$	$I_{ZK}$	$I_R$			Test Voltage $V_R$
			V	mA	$\Omega$	$\Omega$	mA			$\mu A$
1N4728A	3.3	76	10	400	1	100	1	1380	276	
1N4729A	3.6	69	10	400	1	100	1	1260	252	
1N4730A	3.9	64	9	400	1	50	1	1190	234	
1N4731A	4.3	58	9	400	1	10	1	1070	217	
1N4732A	4.7	53	8	500	1	10	1	970	193	
1N4733A	5.1	49	7	550	1	10	1	890	178	
1N4734A	5.6	45	5	600	1	10	2	810	162	
1N4735A	6.2	41	2	700	1	10	3	730	146	
1N4736A	6.8	37	3.5	700	1	10	4	660	133	
1N4737A	7.5	34	4	700	0.5	10	5	605	121	
1N4738A	8.2	31	4.5	700	0.5	10	6	550	110	
1N4739A *	9.1	28	5	700	0.5	10	7	500	100	
1N4740A *	10	25	7	700	0.25	10	7.6	454	91	
1N4741A *	11	23	8	700	0.25	5	8.4	414	83	
1N4742A *	12	21	9	700	0.25	5	9.1	380	76	
1N4743A *	13	19	10	100	0.25	5	9.9	344	69	
1N4744A *	15	17	14	700	0.25	5	11.4	304	61	
1N4745A *	16	15.5	16	700	0.25	5	12.2	285	57	
1N4746A *	18	14	20	750	0.25	5	13.7	250	50	
1N4747A *	20	12.5	22	750	0.25	5	15.2	225	45	
1N4748A *	22	11.5	23	750	0.25	5	16.7	205	41	
1N4749A *	24	10.5	25	750	0.25	5	18.2	190	38	
1N4750A *	27	9.5	35	750	0.25	5	20.6	170	34	
1N4751A *	30	8.5	40	1000	0.25	5	22.8	150	30	
1N4752A *	33	7.5	45	1000	0.25	5	25.1	135	27	
1N4753A *	36	7	50	1000	0.25	5	27.4	125	25	
1N4754A *	39	6.5	60	1000	0.25	5	29.7	115	23	
1N4755A *	43	6	70	1500	0.25	5	32.7	110	22	
1N4756A *	47	5.5	80	1500	0.25	5	35.8	95	19	
1N4757A *	51	5	95	1500	0.25	5	38.8	90	18	
1N4758A *	56	4.5	110	2000	0.25	5	42.6	80	16	
1N4759A *	62	4	125	2000	0.25	5	47.1	70	14	
1N4760A *	68	3.7	150	2000	0.25	5	51.7	65	13	
1N4761A *	75	3.3	175	2000	0.25	5	56	60	12	
1N4762A *	82	3.0	200	3000	0.25	5	62.2	55	11	
1N4763A *	91	2.8	250	3000	0.25	5	69.2	50	10	
1N4764A *	100	2.5	350	3000	0.25	5	76.0	45	9	

<sup>1)</sup> Based on dc-measurement at thermal equilibrium while maintaining the lead temperature ( $T_L$ ) at  $30^\circ C + 1^\circ C$ , 9.5 mm (3/8 ") from the diode body.

<sup>2)</sup> Valid provided that electrodes at a distance of 10 mm from case are kept at ambient temperature.

<sup>3)</sup> Additional measurement of Voltage group 9V1 to 75 at 95 %  $V_{zmin} \leq 35$  nA at  $T_j$  25 °C

## Typical Characteristics ( $T_{amb} = 25\text{ }^{\circ}\text{C}$ unless otherwise specified)

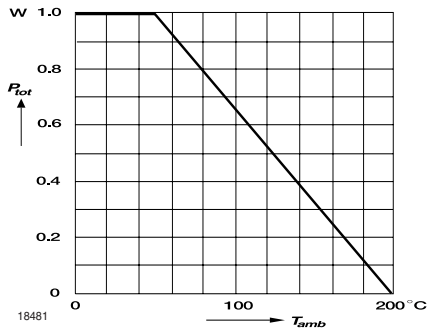

Figure 1. Admissible Power Dissipation vs. Ambient Temperature

**DO-41 Glass Package Dimension**  
see Package Section

# 1N4728A to 1N4764A

Vishay Semiconductors

---



## Small Signal Zener Diodes

### Features

- Silicon Planar Power Zener Diodes.
- Standard Zener voltage tolerance is  $\pm 5\%$ .
- These diodes are also available in MiniMELF case with the type designation TZM5221 ...TZM5267, SOT-23 case with the type designation MMBZ5225 ...MMBZ5267 and SOD-123 case with the types designation MMSZ5225 ... MMSZ5267

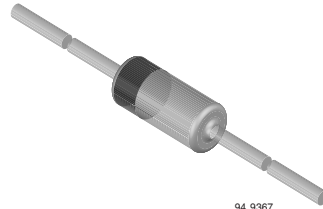

94 9367

### Applications

Voltage stabilization

### Mechanical Data

**Case:** DO-35 Glass case

**Weight:** approx. 125 mg

**Packaging codes/options:**

TAP / 10 k per Ammopack (52 mm tape), 30 k/box

TR / 10 k per 13 " reel , 30 k/box

### Absolute Maximum Ratings

$T_{amb} = 25\text{ }^{\circ}\text{C}$ , unless otherwise specified

Parameter	Test condition	Symbol	Value	Unit
Power dissipation	$T_L \leq 75\text{ }^{\circ}\text{C}$	$P_V$	500	mW
Z-current		$I_Z$	$P_V/V_Z$	mA
Junction temperature		$T_j$	200	$^{\circ}\text{C}$
Storage temperature range		$T_{stg}$	- 65 to + 200	$^{\circ}\text{C}$

### Thermal Characteristics

$T_{amb} = 25\text{ }^{\circ}\text{C}$ , unless otherwise specified

Parameter	Test condition	Symbol	Value	Unit
Junction ambient	$l = 9.5\text{ mm (3/8" )}$ , $T_L = \text{constant}$	$R_{thJA}$	300	K/W

### Electrical Characteristics

$T_{amb} = 25\text{ }^{\circ}\text{C}$ , unless otherwise specified

Parameter	Test condition	Symbol	Min	Typ.	Max	Unit
Forward voltage	$I_F = 200\text{ mA}$	$V_F$			1.1	V

# 1N5221B to 1N5267B



Vishay Semiconductors

## Electrical Characteristics

1N5221B...1N5267B

Partnumber	Nominal Zener Voltage <sup>1)</sup>	Test Current	Maximum Dynamic Impedance <sup>1)</sup>	Maximum Dynamic Impedance	Typical Temperature of Coefficient	Maximum Reverse Leakage Current	
	@ $I_{ZT}$ , $V_Z$					$I_{ZT}$	$Z_{ZK}$ @ $I_{ZK} = 0.25$ mA
	V	mA	$\Omega$	$\Omega$	$\alpha$ (%/K)	$\mu$ A	V
1N5221B	2.4	20	30	1200	-0.085	100	1
1N5222B	2.5	20	30	1250	-0.085	100	1
1N5223B	2.7	20	30	1300	-0.080	75	1
1N5224B	2.8	20	30	1400	-0.080	75	1
1N5225B	3	20	29	1600	-0.075	50	1
1N5226B	3.3	20	28	1600	-0.070	25	1
1N5227B	3.6	20	24	1700	-0.065	15	1
1N5228B	3.9	20	23	1900	-0.060	10	1
1N5229B	4.3	20	22	2000	+0.055	5	1
1N5230B	4.7	20	19	1900	+0.030	5	2
1N5231B	5.1	20	17	1600	+0.030	5	2
1N5232B	5.6	20	11	1600	+0.038	5	3
1N5233B	6	20	7	1600	+0.038	5	3.5
1N5234B	6.2	20	7	1000	+0.045	5	4
1N5235B	6.8	20	5	750	+0.050	3	5
1N5236B	7.5	20	6	500	+0.058	3	6
1N5237B	8.2	20	8	500	+0.062	3	6.5
1N5238B	8.7	20	8	600	+0.065	3	6.5
1N5239B	9.1	20	10	600	+0.068	3	7
1N5240B	10	20	17	600	+0.075	3	8
1N5241B	11	20	22	600	+0.076	2	8.4
1N5242B	12	20	30	600	+0.077	1	9.1
1N5243B	13	9.5	13	600	+0.079	0.5	9.9
1N5244B	14	9	15	600	+0.082	0.1	10
1N5245B	15	8.5	16	600	+0.082	0.1	11
1N5246B	16	7.8	17	600	+0.083	0.1	12
1N5247B	17	7.4	19	600	+0.084	0.1	13
1N5248B	18	7	21	600	+0.085	0.1	14
1N5249B	19	6.6	23	600	+0.086	0.1	14
1N5250B	20	6.2	25	600	+0.086	0.1	15
1N5251B	22	5.6	29	600	+0.087	0.1	17
1N5252B	24	5.2	33	600	+0.088	0.1	18
1N5253B	25	5	35	600	+0.089	0.1	19
1N5254B	27	4.6	41	600	+0.090	0.1	21
1N5255B	28	4.5	44	600	+0.091	0.1	21
1N5256B	30	4.2	49	600	+0.091	0.1	23
1N5257B	33	3.8	58	700	+0.092	0.1	25
1N5258B	36	3.4	70	700	+0.093	0.1	27
1N5259B	39	3.2	80	800	+0.094	0.1	30
1N5260B	43	3	93	900	+0.095	0.1	33
1N5261B	47	2.7	105	1000	+0.095	0.1	36
1N5262B	51	2.5	125	1100	+0.096	0.1	39
1N5263B	56	2.2	150	1300	+0.096	0.1	43
1N5264B	60	2.1	170	1400	+0.097	0.1	46

Partnumber	Nominal Zener Voltage <sup>1)</sup>	Test Current	Maximum Dynamic Impedance <sup>1)</sup>	Maximum Dynamic Impedance	Typical Temperature of Coefficient	Maximum Reverse Leakage Current	
	@ $I_{ZT}$ , $V_Z$					$I_{ZT}$	$Z_{ZT}$ @ $I_{ZT}$
	V	mA	$\Omega$	$\Omega$	$\alpha$ (%/K)	$\mu$ A	V
1N5265B	62	2	185	1400	+0.097	0.1	47
1N5266B	68	1.8	230	1600	+0.097	0.1	52
1N5267B	75	1.7	270	1700	+0.098	0.1	56

<sup>1)</sup> Based on dc-measurement at thermal equilibrium; lead length = 9.5 (3/8 "); thermal resistance of heat sink = 30 K/W

### Typical Characteristics ( $T_{amb} = 25^\circ\text{C}$ unless otherwise specified)

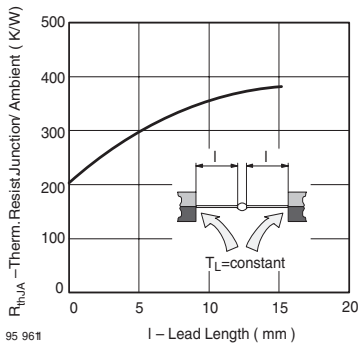

Figure 1. Thermal Resistance vs. Lead Length

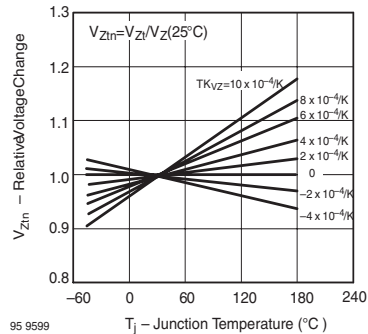

Figure 3. Typical Change of Working Voltage vs. Junction Temperature

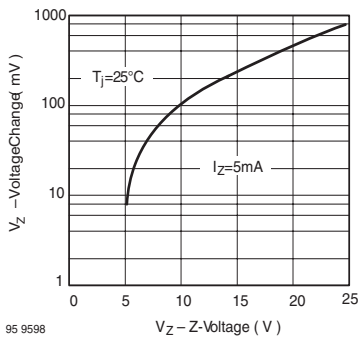

Figure 2. Typical Change of Working Voltage under Operating Conditions at  $T_{amb}=25^\circ\text{C}$

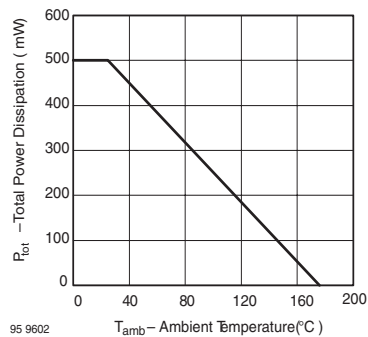

Figure 4. Total Power Dissipation vs. Ambient Temperature



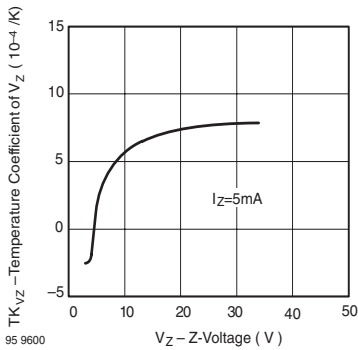

Figure 5. Temperature Coefficient of Vz vs. Z-Voltage

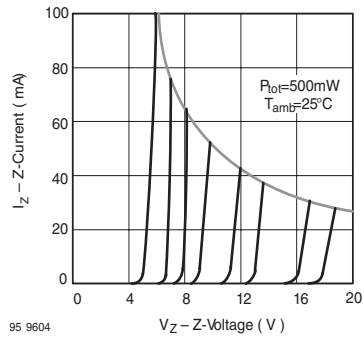

Figure 8. Z-Current vs. Z-Voltage

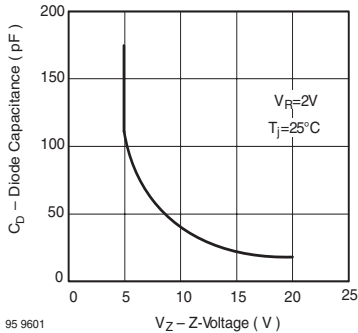

Figure 6. Diode Capacitance vs. Z-Voltage

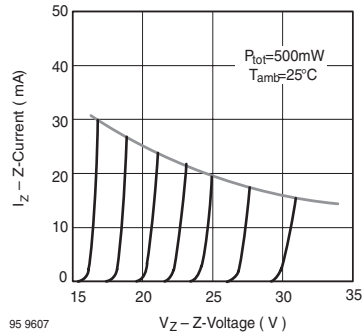

Figure 9. Z-Current vs. Z-Voltage

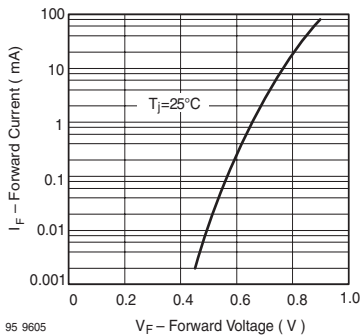

Figure 7. Forward Current vs. Forward Voltage

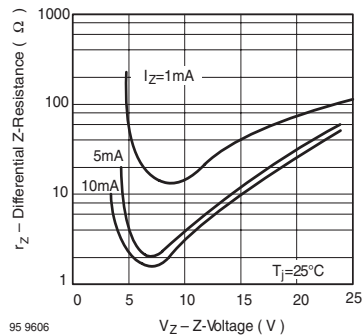

Figure 10. Differential Z-Resistance vs. Z-Voltage

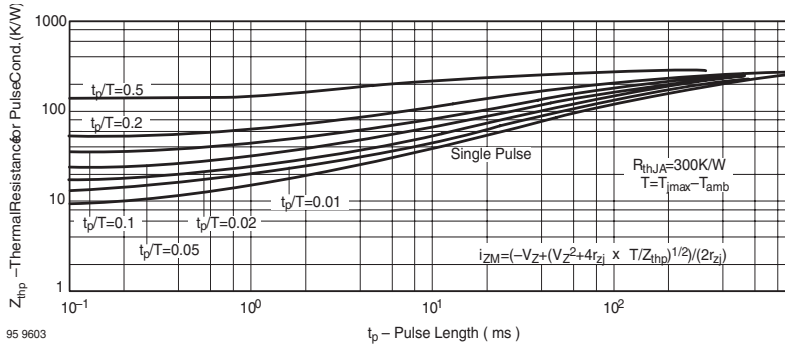

Figure 11. Thermal Response

**DO-35 Package Dimension**  
 see Package Section

# 1N5221B to 1N5267B

Vishay Semiconductors

---



## Small Signal Zener Diodes

### Features

- Silicon Planar Power Zener Diodes.
- Standard Zener voltage tolerance is  $\pm 5\%$  for "A" suffix.

### Mechanical Data

**Case:** DO-35 Glass case

**Weight:** approx. 125 mg

**Packaging codes/options:**

TR / 10 k per 13 " reel, 30 k/box

TAP / 10 k per Ammo tape (52 mm tape), 30 k/box



### Absolute Maximum Ratings

$T_{amb} = 25\text{ }^{\circ}\text{C}$ , unless otherwise specified

Parameter	Test condition	Symbol	Value	Unit
Zener current (see Table "Characteristics")				
Power dissipation	$T_{amb} = 75\text{ }^{\circ}\text{C}$	$P_{tot}$	500 <sup>1)</sup>	mW

<sup>1)</sup>  $T_L$  is measured that leads at a distance of 3/8 " from case are kept at ambient temperature

### Thermal Characteristics

$T_{amb} = 25\text{ }^{\circ}\text{C}$ , unless otherwise specified

Parameter	Test condition	Symbol	Value	Unit
Thermal resistance junction to ambient air		$R_{thJA}$	300 <sup>1)</sup>	$^{\circ}\text{C}/\text{W}$
Maximum junction temperature		$T_j$	175	$^{\circ}\text{C}$
Storage temperature range		$T_S$	- 65 to + 175	$^{\circ}\text{C}$

<sup>1)</sup> Valid provided that leads at a distance of 3/8 " from case are kept at ambient temperature

# 1N746A to 1N759A



Vishay Semiconductors

## Electrical Characteristics

Partnumber	Nominal Zener Voltage	Test Current	Maximum Dynamic Impedance	Maximum Regulator Current	Maximum Reverse Leakage Current $I_R @ V_R = 1 V$					
					$V_Z @ I_{ZT}^{(3)}$	$I_{ZT}$	$Z_{ZT} @ I_{ZT}^{(1)}$	$I_{ZM}^{(2)}$	$T_{amb} = 25\text{ }^\circ\text{C}$	$T_{amb} = 150\text{ }^\circ\text{C}$
					V	mA	$\Omega$	mA	$\mu\text{A}$	$\mu\text{A}$
1N746A	3.3	20	28	110	10	30				
1N747A	3.6	20	24	100	10	30				
1N748A	3.9	20	23	95	10	30				
1N749A	4.3	20	22	85	2	30				
1N750A	4.7	20	19	75	2	30				
1N751A	5.1	20	17	70	1	20				
1N752A	5.6	20	11	65	1	20				
1N753A	6.2	20	7	60	0.1	20				
1N754A	6.8	20	5	55	0.1	20				
1N755A	7.5	20	6	50	0.1	20				
1N756A	8.2	20	8	45	0.1	20				
1N757A	9.1	20	10	40	0.1	20				
1N758A	10	20	17	35	0.1	20				
1N759A	12	20	30	30	0.1	20				

<sup>1)</sup>The Zener impedance is derived from the 1 kHz AC voltage which results when an AC current having an RMS value equal to 10 % of the Zener current ( $I_{ZT}$ ) is superimposed on  $I_{ZT}$ . Zener impedance is measured at two points to insure a sharp knee on the breakdown curve and to eliminate unstable units.

<sup>2)</sup>Valid provided that leads at a distance of 3/8 " from case are kept at ambient temperature.

<sup>3)</sup>Measured with device junction in thermal equilibrium.

**DO-35 Package Dimension**  
see Package Section



## Small Signal Zener Diodes

### Features

- Very sharp reverse characteristic
- Siliconic Planar Power Zener Diodes.
- Very high stability
- Low reverse current level
- $V_Z$ -tolerance  $\pm 5\%$



### Applications

Voltage stabilization

### Mechanical Data

**Case:** DO-35 Glass case

**Weight:** approx. 125 mg

**Packaging codes/options:**

TR / 10 k per 13 " reel, 30 k/box

TAP / 10 k per Ammo tape (52 mm tape), 30 k/box

### Absolute Maximum Ratings

$T_{amb} = 25\text{ }^{\circ}\text{C}$ , unless otherwise specified

Parameter	Test condition	Symbol	Value	Unit
Zener current table (see Table " Characteristics ")				
Power dissipation		$P_{tot}$	500 <sup>1)</sup>	mW

<sup>1)</sup> Valid provided that leads at a distance of 3/8 " from case kept at ambient temperature.

### Thermal Characteristics

$T_{amb} = 25\text{ }^{\circ}\text{C}$ , unless otherwise specified

Parameter	Test condition	Symbol	Value	Unit
Thermal resistance junction to ambient air		$R_{thJA}$	300 <sup>1)</sup>	$^{\circ}\text{C/W}$
Junction temperature		$T_J$	175	$^{\circ}\text{C}$
Storage temperature range		$T_S$	- 65 to + 175	$^{\circ}\text{C}$

<sup>1)</sup> Valid provided that leads at a distance of 3/8 " from case kept at ambient temperature.

### Electrical Characteristics

Partnumber	Nominal Zener Voltage	Test Current	Maximum Zener Impedance <sup>1)</sup>			Maximum Regulator Current	Maximum Reverse Current	
			$Z_{ZT} @ I_{ZT}$	$Z_{ZK} @ I_{ZK}$	$I_{ZK}$		Maximum $I_R$	Test Voltage $V_{dc}$
			$V_Z$ <sup>3)</sup>	$I_{ZT}$	$I_{ZK}$			
V	mA	$\Omega$	$\Omega$	mA	mA	$\mu A$	V	
1N957B	6.8	18.5	4.5	700	1	58	150	5.2
1N958B	7.5	16.5	5.5	700	0.5	53	75	5.7
1N959B	8.2	15	6.5	700	0.5	47	50	6.2
1N960B	9.1	14	7.5	700	0.5	43	25	6.9
1N961B	10	12.5	8.5	700	0.25	40	10	7.6
1N962B	11	11.5	9.5	700	0.25	36	5	8.4
1N963B	12	10.5	11.5	700	0.25	32	5	9.1
1N964B	13	9.5	13	700	0.25	29	5	9.9
1N965B	15	8.5	16	700	0.25	27	5	11.4
1N966B	16	7.8	17	700	0.25	24	5	12.2
1N967B	18	7	21	750	0.25	21	5	13.7
1N968B	20	6.2	25	750	0.25	20	5	15.2
1N969B	22	5.6	29	750	0.25	18	5	16.7
1N970B	24	5.2	33	750	0.25	16	5	18.2
1N971B	27	4.6	41	750	0.25	14	5	20.6
1N972B	30	4.2	49	1000	0.25	13	5	22.8
1N973B	33	3.8	58	1000	0.25	12	5	25.1
1N974B	36	3.4	70	1000	0.25	11	5	27.4
1N975B	39	3.2	80	1000	0.25	10	5	29.7
1N976B	43	3	93	1500	0.25	9.2	5	32.7
1N977B	47	2.7	105	1500	0.25	8.5	5	35.8
1N978B	51	2.5	125	1500	0.25	7.8	5	38.8
1N979B	56	2.2	150	2000	0.25	6.9	5	42.6
1N980B	62	2	185	2000	0.25	6.3	5	47.1
1N981B	68	1.8	230	2000	0.25	5.7	5	51.7
1N982B	75	1.7	270	2000	0.25	5.2	5	56
1N983B	82	1.5	330	3000	0.25	4.7	5	62.2
1N984B	91	1.4	440	3000	0.25	4.3	5	69.2

<sup>1)</sup>The Zener Impedance is derived from the 1 kHz AC voltage which results when an AC current having an RMS value equal to 10 % of the Zener current ( $I_{ZT}$ ) is superimposed on  $I_{ZT}$ . Zener Impedance is measured at two points to insure a sharp knee on the breakdown curve and to eliminate unstable units.

<sup>2)</sup> Valid provided that leads at a distance of 3/8" from case are kept at 25 °C ambient temperature.

<sup>3)</sup> Measured with device junction in thermal equilibrium.

### DO-35 Package Dimension see Package Section

## Small Signal Zener Diodes, Dual

### Features

- These diodes are also available in other case styles and configurations including: the dual diode common cathode configuration with type designation DZ23, the single diode SOT-23 case with the type designation BZX84C, and the single diode SOD-123 case with the type designation BZT52C.
- Dual Silicon Planar Zener Diodes, Common Anode
- The Zener voltages are graded according to the international E 24 standard.
- The parameters are valid for both diodes in one case.  $\Delta V_Z$  and  $\Delta r_{zj}$  of the two diodes in one case is  $\leq 5\%$

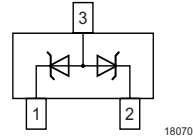
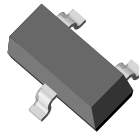

### Mechanical Data

**Case:** SOT-23 Plastic case

**Weight:** approx. 8.8 mg

**Packaging Codes/Options:**

GS18 / 10 k per 13 " reel, (8 mm tape), 10 k/box

GS08 / 3 k per 7 " reel, (8 mm tape), 15 K/box

### Absolute Maximum Ratings

$T_{amb} = 25\text{ }^\circ\text{C}$ , unless otherwise specified

Parameter	Test condition	Symbol	Value	Unit
Power dissipation		$P_{tot}$	300 <sup>1)</sup>	mW

<sup>1)</sup> Device on fiberglass substrate, see layout

### Thermal Characteristics

$T_{amb} = 25\text{ }^\circ\text{C}$ , unless otherwise specified

Parameter	Test condition	Symbol	Value	Unit
Thermal resistance junction to ambient air		$R_{thJA}$	420 <sup>1)</sup>	$^\circ\text{C/W}$
Junction temperature		$T_j$	150	$^\circ\text{C}$
Storage temperature range		$T_S$	- 65 to + 150	$^\circ\text{C}$

<sup>1)</sup> Device on fiberglass substrate, see layout



### Electrical Characteristics

Partnumber	Marking Code	Zener Voltage Range <sup>1)</sup>		Dynamic Resistance		Test Current	Temperature Coefficient of Zener Voltage		Reverse Voltage
		$V_Z @ I_{ZT}$		$r_{zj} @$ $I_{ZT} = 5 \text{ mA},$ $f = 1 \text{ kHz}$	$r_{zj} @$ $I_{ZT} = 1 \text{ mA},$ $f = 1 \text{ kHz}$		$I_{ZT}$	$\alpha_{VZ} @ I_{ZT}$	
		V		$\Omega$		mA	$10^{-4}/^{\circ}\text{C}$		V
		min	max				min	max	
AZ23C2V7	D1	2.5	2.9	75 (<83)	<500	5	-9	-4	-
AZ23C3V0	D2	2.8	3.2	80 (<95)	<500	5	-9	-3	-
AZ23C3V3	D3	3.1	3.5	80 (<95)	<500	5	-8	-3	-
AZ23C3V6	D4	3.4	3.8	80 (<95)	<500	5	-8	-3	-
AZ23C3V9	D5	3.7	4.1	80 (<95)	<500	5	-7	-3	-
AZ23C4V3	D6	4	4.6	80 (<95)	<500	5	-6	-1	-
AZ23C4V7	D7	4.4	5	70 (<78)	<500	5	-5	2	-
AZ23C5V1	D8	4.8	5.4	30 (<60)	<480	5	-3	4	>0.8
AZ23C5V6	D9	5.2	6	10 (<40)	<400	5	-2	6	>1
AZ23C6V2	D10	5.8	6.6	4.8 (<10)	<200	5	-1	7	>2
AZ23C6V8	D11	6.4	7.2	4.5 (<8)	<150	5	2	7	>3
AZ23C7V5	D12	7	7.9	4 (<7)	<50	5	-3	7	>5
AZ23C8V2	D13	7.7	8.7	4.5 (<7)	<50	5	4	7	>6
AZ23C9V1	D14	8.5	9.6	4.8 (<10)	<50	5	5	8	>7
AZ23C10	D15	9.4	10.6	5.2 (<15)	<70	5	5	8	>7.5
AZ23C11	D16	10.4	11.6	6 (<20)	<70	5	5	9	>8.5
AZ23C12	D17	11.4	12.7	7 (<20)	<90	5	6	9	>9
AZ23C13	D18	12.4	14.1	9 (<25)	<110	5	7	9	>10
AZ23C15	D19	13.8	15.6	11 (<30)	<110	5	7	9	>11
AZ23C16	D20	15.3	17.1	13 (<40)	<170	5	8	9.5	>12
AZ23C18	D21	16.8	19.1	18 (<50)	<170	5	8	9.5	>14
AZ23C20	D22	18.8	21.2	20 (<50)	<220	5	8	10	>15
AZ23C22	D23	20.8	23.3	25 (<55)	<220	5	8	10	>17
AZ23C24	D24	22.8	25.6	28 (<80)	<220	5	8	10	>18
AZ23C27	D25	25.1	28.9	30 (<80)	<250	5	8	10	>20
AZ23C30	D26	28	32	35 (<80)	<250	5	8	10	>22.5
AZ23C33	D27	31	35	40 (<80)	<250	5	8	10	>25
AZ23C36	D28	34	38	40 (<90)	<250	5	8	10	>27
AZ23C39	D29	37	41	50 (<90)	<300	5	10	12	>29
AZ23C43	D30	40	46	60 (<100)	<700	5	10	12	>32
AZ23C47	D31	44	50	70 (<100)	<750	5	10	12	>35
AZ23C51	D32	48	54	70 (<100)	<750	5	10	12	>38

<sup>1)</sup> Tested with pulses  $t_p = 5 \text{ ms}$

### Electrical Characteristics

Partnumber	Marking Code	Zener Voltage Range <sup>1)</sup>		Dynamic Resistance		Test Current	Temperature Coefficient of Zener Voltage		Reverse Voltage		
		$V_Z @ I_{ZT}$		$r_{zj} @$	$r_{zj} @$		$I_{ZT}$	$\alpha_{VZ} @ I_{ZT}$		$V_R @ I_R = 100 \text{ nA}$	
		V		$\Omega$				mA			$10^{-4}/^{\circ}\text{C}$
min	max				min	max					
AZ23B2V7	D1	2.65	2.75	75 (<83)	<500	5	-9	-4	-		
AZ23B3V0	D2	2.94	3.06	80 (<95)	<500	5	-9	-3	-		
AZ23B3V3	D3	3.23	3.37	80 (<95)	<500	5	-8	-3	-		
AZ23B3V6	D4	3.53	3.67	80 (<95)	<500	5	-8	-3	-		
AZ23B3V9	D5	3.82	3.98	80 (<95)	<500	5	-7	-3	-		
AZ23B4V3	D6	4.21	4.39	80 (<95)	<500	5	-6	-1	-		
AZ23B4V7	D7	4.61	4.79	70 (<78)	<500	5	-5	2	-		
AZ23B5V1	D8	5	5.2	30 (<60)	<480	5	-3	4	>0.8		
AZ23B5V6	D9	5.49	5.71	10 (<40)	<400	5	-2	6	>1		
AZ23B6V2	D10	6.08	6.32	4.8 (<10)	<200	5	-1	7	>2		
AZ23B6V8	D11	6.66	6.94	4.5 (<8)	<150	5	2	7	>3		
AZ23B7V5	D12	7.35	7.65	4 (<7)	<50	5	-3	7	>5		
AZ23B8V2	D13	8.04	8.36	4.5 (<7)	<50	5	4	7	>6		
AZ23B9V1	D14	8.92	9.28	4.8 (<15)	<50	5	5	8	>7		
AZ23B10	D15	9.8	10.2	5.2 (<10)	<70	5	5	8	>7.5		
AZ23B11	D16	10.8	11.2	6 (<20)	<70	5	5	9	>8.5		
AZ23B12	D17	11.8	12.2	7 (<20)	<90	5	6	9	>9		
AZ23B13	D18	12.7	13.3	9 (<25)	<110	5	7	9	>10		
AZ23B15	D19	14.7	15.3	11 (<30)	<110	5	7	9	>11		
AZ23B16	D20	15.7	16.3	13 (<40)	<170	5	8	0.5	>12		
AZ23B18	D21	17.6	18.4	18 (<50)	<170	5	8	0.5	>14		
AZ23B20	D22	19.6	20.4	20 (<50)	<220	5	8	10	>15		
AZ23B22	D23	21.6	22.4	25 (<55)	<220	5	8	10	>17		
AZ23B24	D24	23.5	24.5	28 (<80)	<220	5	8	10	>18		
AZ23B27	D25	26.5	27.5	30 (<80)	<250	5	8	10	>20		
AZ23B30	D26	29.4	30.6	35 (<80)	<250	5	8	10	>22.5		
AZ23B33	D27	32.3	33.7	40 (<80)	<250	5	8	10	>25		
AZ23B36	D28	35.3	36.7	40 (<90)	<250	5	8	10	>27		
AZ23B39	D29	38.2	39.8	50 (<90)	<300	5	10	12	>29		
AZ23B43	D30	42.1	43.9	60 (<100)	<700	5	10	12	>32		
AZ23B47	D31	46.1	47.9	70 (<100)	<750	5	10	12	>35		
AZ23B51	D32	50	52	70 (<100)	<750	5	10	12	>38		

<sup>1)</sup> Tested with pulses  $t_p = 5 \text{ ms}$

## Typical Characteristics ( $T_{amb} = 25\text{ }^{\circ}\text{C}$ unless otherwise specified)

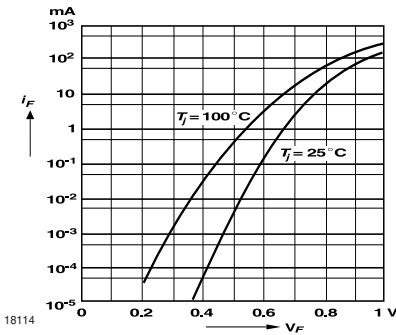

Figure 1. Forward characteristics

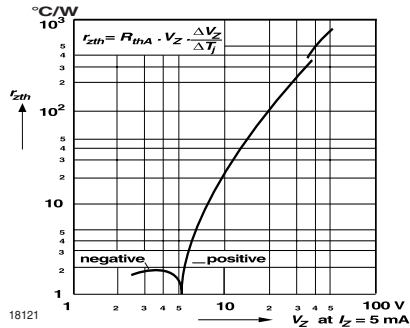

Figure 4. Thermal Differential Resistance vs. Zener Voltage

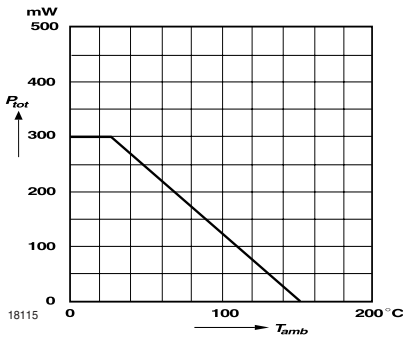

Figure 2. Admissible Power Dissipation vs. Ambient Temperature

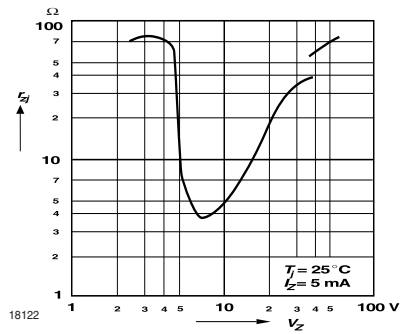

Figure 5. Dynamic Resistance vs. Zener Voltage

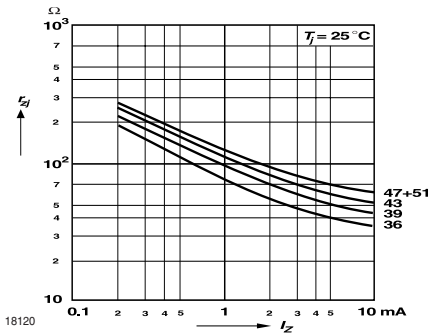

Figure 3. Dynamic Resistance vs. Zener Current

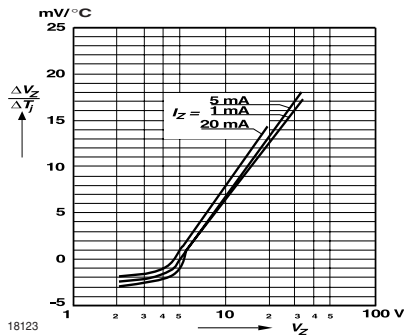

Figure 6. Temperature Dependence of Zener Voltage vs. Zener Voltage

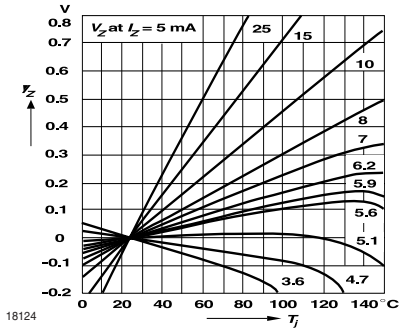

Figure 7. Change of Zener Voltage vs. Junction Temperature

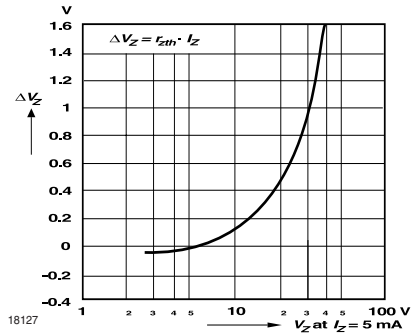

Figure 10. Change of Zener voltage from turn-on up to the point of thermal equilibrium vs. Zener voltage

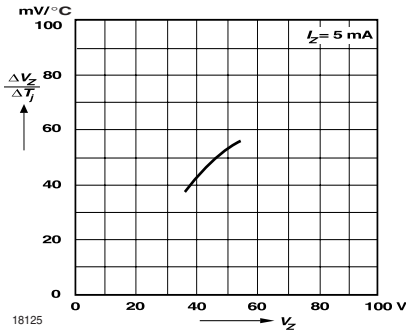

Figure 8. Temperature Dependence of Zener Voltage vs. Zener Voltage

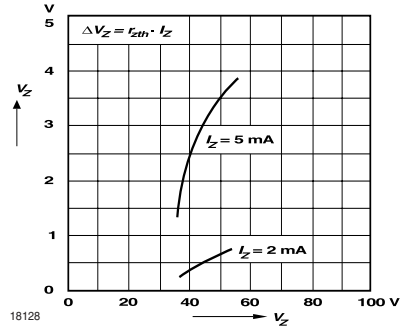

Figure 11. Change of Zener voltage from turn-on up to the point of thermal equilibrium vs. Zener voltage

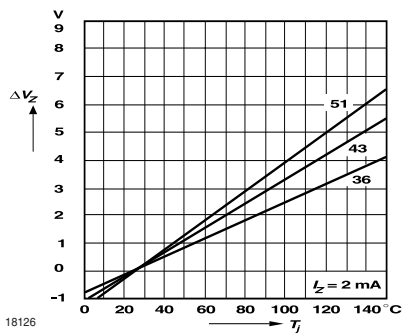

Figure 9. Change of Zener Voltage vs. Junction Temperature

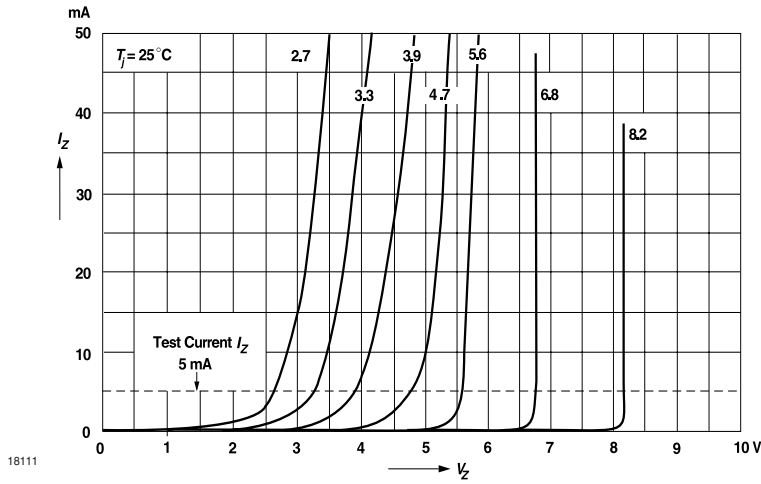

Figure 12. Breakdown Characteristics

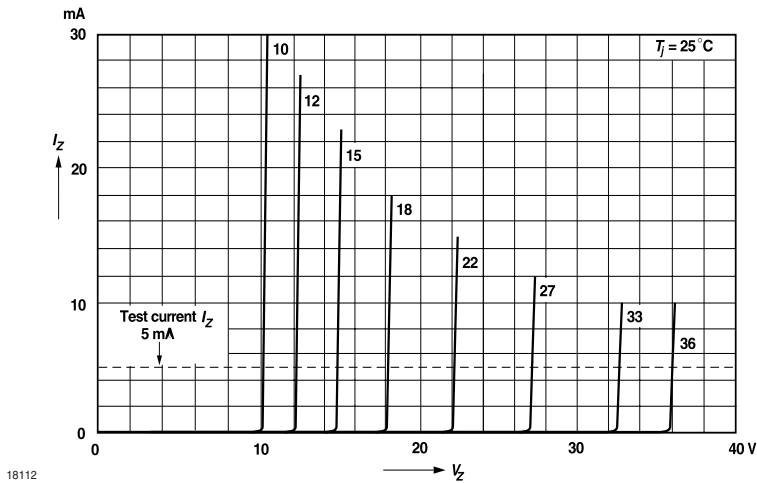
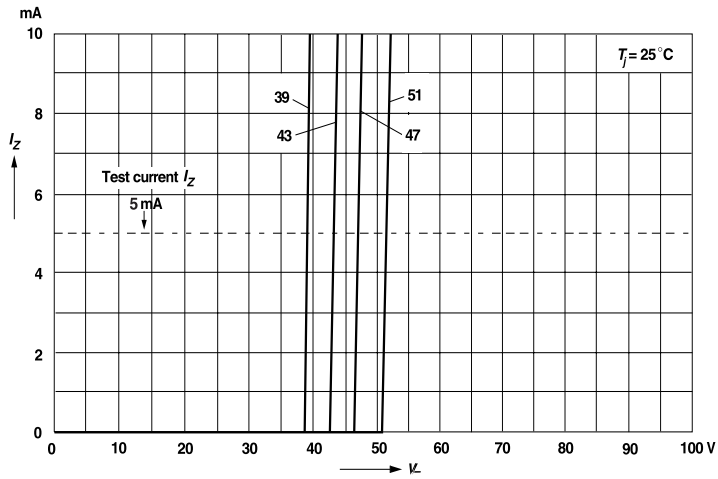

Figure 13. Breakdown Characteristics



18113

Figure 14. Breakdown Characteristics

**SOT-23 Package Dimension**  
see Package Section

# AZ23-Series

Vishay Semiconductors

---



## Zener Diodes with Surge Current Specification

### Features

- Silicon Planar Zener Diodes
- Low profile surface-mount package
- Zener and surge current specification
- Low leakage current
- Excellent stability
- High temperature soldering:  
260 °C/10 sec. at terminals

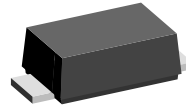

17249

### Mechanical Data

**Case:** JEDEC DO-219AB (SMF<sup>®</sup>) Plastic case

**Weight:** approx. 15 mg

#### Packaging codes/options:

GS18 / 10 k per 13 " reel, (8 mm tape), 50 k/box

GS08 / 3 k per 7 " reel, (8 mm tape), 30 k/box

### Absolute Maximum Ratings

T<sub>amb</sub> = 25 °C, unless otherwise specified

Parameter	Test condition	Symbol	Value	Unit
Power dissipation	T <sub>L</sub> = 80 °C	P <sub>tot</sub>	2.3	W
	T <sub>A</sub> = 25 °C	P <sub>tot</sub>	0.8 <sup>1)</sup>	W
Non-repetitive peak pulse power dissipation	100 μs square pulse <sup>2)</sup>	P <sub>ZSM</sub>	300	W
	10/1000 μs waveform (BZD27-C7V5P to BZD27-C100P) <sup>2)</sup>	P <sub>RSM</sub>	150	W
	10/1000 μs waveform (BZD27-C110P to BZD27-C200P) <sup>2)</sup>	P <sub>RSM</sub>	100	W

<sup>1)</sup> Mounted on epoxy-glass PCB with 3 x 3 mm Cu pads (≥ 40 μm thick)

<sup>2)</sup> T<sub>J</sub> = 25 °C prior to surge

### Thermal Characteristics

T<sub>amb</sub> = 25 °C, unless otherwise specified

Parameter	Test condition	Symbol	Value	Unit
Thermal resistance junction to ambient air <sup>1)</sup>		R <sub>thJA</sub>	180	K/W
Thermal resistance junction to lead		R <sub>thJL</sub>	30	K/W
Maximum junction temperature		T <sub>j</sub>	150	°C
Storage temperature range		T <sub>S</sub>	- 55 to + 150	°C

<sup>1)</sup> Mounted on epoxy-glass PCB with 3 x 3 mm Cu pads (≥ 40 μm thick)



# BZD27C3V6P to BZD27C200P



Vishay Semiconductors

## Electrical Characteristics

$T_{amb} = 25\text{ }^{\circ}\text{C}$ , unless otherwise specified

Parameter	Test condition	Symbol	Min	Typ.	Max	Unit
Forward voltage	$I_F = 0.2\text{ A}$	$V_F$			1.2	V



# BZD27C3V6P to BZD27C200P

Vishay Semiconductors

## Electrical Characteristics

When used as voltage regulator diodes ( $T_J = 25\text{ }^\circ\text{C}$  unless otherwise noted)

Partnumber	Marking Code	Working Voltage <sup>1)</sup>		Differential Resistance		Temperature Coefficient		Test Current	Reverse Current at Reverse Voltage	
		$V_Z @ I_{ZT}$		$r_{dif} @ I_Z$		$\alpha_Z @ I_Z$		$I_{ZT}$	$I_R$	$V_R$
		V		$\Omega$		%/°C		mA	$\mu\text{A}$	V
		min	max	typ	max	min	max		max	
BZD27C3V6P	D0	3.4	3.8	4	8	-0.14	-0.04	100	100	1
BZD27C3V9P	D1	3.7	4.1	4	8	-0.14	-0.04	100	50	1
BZD27C4V3P	D2	4	4.6	4	7	-0.12	-0.02	100	25	1
BZD27C4V7P	D3	4.4	5	3	7	-0.1	0	100	10	1
BZD27C5V1P	D4	4.8	5.4	3	6	-0.08	0.02	100	5	1
BZD27C5V6P	D5	5.2	6	2	4	-0.04	0.04	100	10	2
BZD27C6V2P	D6	5.8	6.6	2	3	-0.01	0.06	100	5	2
BZD27C6V8P	D7	6.4	7.2	1	3	0	0.07	100	10	3
BZD27C7V5P	D8	7	7.9	1	2	0	0.07	100	50	3
BZD27C8V2P	D9	7.7	8.7	1	2	0.03	0.08	100	10	3
BZD27C9V1P	E0	8.5	9.6	2	4	0.03	0.08	50	10	5
BZD27C10P	E1	9.4	10.6	2	4	0.05	0.09	50	7	7.5
BZD27C11P	E2	10.4	11.6	4	7	0.05	0.1	50	4	8.2
BZD27C12P	E3	11.4	12.7	4	7	0.05	0.1	50	3	9.1
BZD27C13P	E4	12.4	14.1	5	10	0.05	0.1	50	2	10
BZD27C15P	E5	13.8	15.6	5	10	0.05	0.1	50	1	11
BZD27C16P	E6	15.3	17.1	6	15	0.06	0.11	25	1	12
BZD27C18P	E7	16.8	19.1	6	15	0.06	0.11	25	1	13
BZD27C20P	E8	18.8	21.2	6	15	0.06	0.11	25	1	15
BZD27C22P	E9	20.8	23.3	6	15	0.06	0.11	25	1	16
BZD27C24P	F0	22.8	25.6	7	15	0.06	0.11	25	1	18
BZD27C27P	F1	25.1	28.9	7	15	0.06	0.11	25	1	20
BZD27C30P	F2	28	32	8	15	0.06	0.11	25	1	22
BZD27C33P	F3	31	35	8	15	0.06	0.11	25	1	24
BZD27C36P	F4	34	38	21	40	0.06	0.11	10	1	27
BZD27C39P	F5	37	41	21	40	0.06	0.11	10	1	30
BZD27C43P	F6	40	46	24	45	0.07	0.12	10	1	33
BZD27C47P	F7	44	50	24	45	0.07	0.12	10	1	36
BZD27C51P	F8	48	54	25	60	0.07	0.12	10	1	39
BZD27C56P	F9	52	60	25	60	0.07	0.12	10	1	43
BZD27C62P	G0	58	66	25	80	0.08	0.13	10	1	47
BZD27C68P	G1	64	72	25	80	0.08	0.13	10	1	51
BZD27C75P	G2	70	79	30	100	0.08	0.13	10	1	56
BZD27C82P	G3	77	87	30	100	0.08	0.13	10	1	62
BZD27C91P	G4	85	96	60	200	0.08	0.13	5	1	68
BZD27C100P	G5	94	106	60	200	0.09	0.13	5	1	75
BZD27C110P	G6	104	116	80	250	0.09	0.13	5	1	82
BZD27C120P	G7	114	127	80	250	0.09	0.13	5	1	91
BZD27C130P	G8	124	141	110	300	0.09	0.13	5	1	100
BZD27C150P	G9	138	156	130	300	0.09	0.13	5	1	110
BZD27C160P	H0	153	171	150	350	0.09	0.13	5	1	120
BZD27C180P	H1	168	191	180	400	0.09	0.13	5	1	130
BZD27C200P	H2	188	212	200	500	0.09	0.13	5	1	150

<sup>1)</sup> Pulse test:  $t_p \leq 5\text{ ms}$ .

# BZD27C3V6P to BZD27C200P



Vishay Semiconductors

## Electrical Characteristics

When used as protection diodes ( $T_J = 25\text{ }^\circ\text{C}$  unless otherwise noted)

Partnumber	Rev. Breakdown Voltage $V_{(BR)R}$ at $I_{test}$	Test Current $I_{test}$	Temperature Coefficient		Clamping Voltage		Reverse Current at Stand-Off Voltage	
			$\alpha_Z @ I_{test}$		$V_C$	at $I_{RSM}^{1)}$	$I_R$	at $V_{WM}$
			%/°C		V	A	$\mu\text{A}$	V
			min	max	max		max	
BZD27C7V5P	7	100	0	0.07	11.3	13.3	1500	6.2
BZD27C8V2P	7.7	100	0.03	0.08	12.3	12.2	1200	6.8
BZD27C9V1P	8.5	50	0.03	0.08	13.3	11.3	100	7.5
BZD27C10P	9.4	50	0.05	0.09	14.8	10.1	20	8.2
BZD27C11P	10.4	50	0.05	0.1	15.7	9.6	5	9.1
BZD27C12P	11.4	50	0.05	0.1	17	8.8	5	10
BZD27C13P	12.4	50	0.05	0.1	18.9	7.9	5	11
BZD27C15P	13.8	50	0.05	0.1	20.9	7.2	5	12
BZD27C16P	15.3	25	0.06	0.11	22.9	6.6	5	13
BZD27C18P	16.8	25	0.06	0.11	25.6	5.9	5	15
BZD27C20P	18.8	25	0.06	0.11	28.4	5.3	5	16
BZD27C22P	20.8	25	0.06	0.11	31	4.8	5	18
BZD27C24P	22.8	25	0.06	0.11	33.8	4.4	5	20
BZD27C27P	25.1	25	0.06	0.11	38.1	3.9	5	22
BZD27C30P	28	25	0.06	0.11	42.2	3.6	5	24
BZD27C33P	31	25	0.06	0.11	46.2	3.2	5	27
BZD27C36P	34	10	0.06	0.11	50.1	3	5	30
BZD27C39P	37	10	0.06	0.11	54.1	2.8	5	33
BZD27C43P	40	10	0.07	0.12	60.7	2.5	5	36
BZD27C47P	44	10	0.07	0.12	65.5	2.3	5	39
BZD27C51P	48	10	0.07	0.12	70.8	2.1	5	43
BZD27C56P	52	10	0.07	0.12	78.6	1.9	5	47
BZD27C62P	58	10	0.08	0.13	86.5	1.7	5	51
BZD27C68P	64	10	0.08	0.13	94.4	1.6	5	56
BZD27C75P	70	10	0.08	0.13	103.5	1.5	5	62
BZD27C82P	77	10	0.08	0.13	114	1.3	5	68
BZD27C91P	85	5	0.09	0.13	126	1.2	5	75
BZD27C100P	94	5	0.09	0.13	139	1.1	5	82
BZD27C110P	104	5	0.09	0.13	139	0.72	5	91
BZD27C120P	114	5	0.09	0.13	152	0.65	5	100
BZD27C130P	124	5	0.09	0.13	169	0.59	5	110
BZD27C150P	138	5	0.09	0.13	187	0.53	5	120
BZD27C160P	153	5	0.09	0.13	205	0.48	5	130
BZD27C180P	168	5	0.09	0.13	229	0.43	5	150
BZD27C200P	188	5	0.09	0.13	254	0.39	5	160

<sup>1)</sup> Non-repetitive peak reverse current in accordance with "IEC 60-1, Section 8" (10/1000  $\mu\text{s}$  pulse); see Fig. 5.

## Typical Characteristics ( $T_{amb} = 25\text{ }^{\circ}\text{C}$ unless otherwise specified)

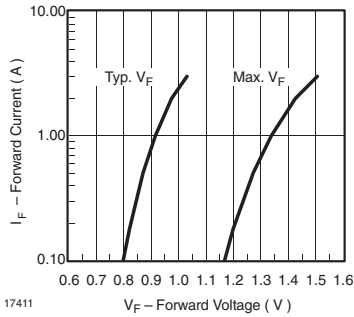

Figure 1. Forward Current vs. Forward Voltage

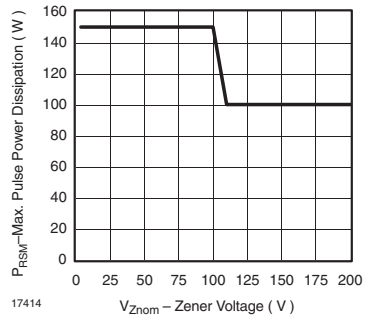

Figure 4. Maximum Pulse Power Dissipation vs. Zener Voltage

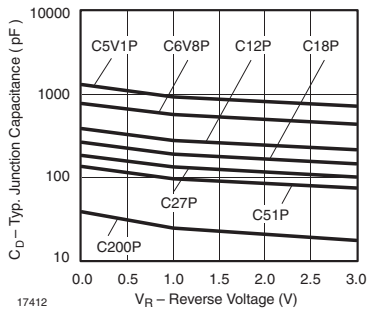

Figure 2. Typ. Diode Capacitance vs. Reverse Voltage

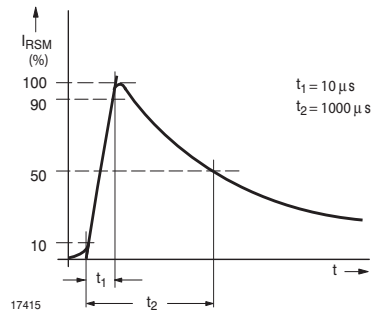

Figure 5. Non-Repetitive Peak Reverse Current Pulse Definition

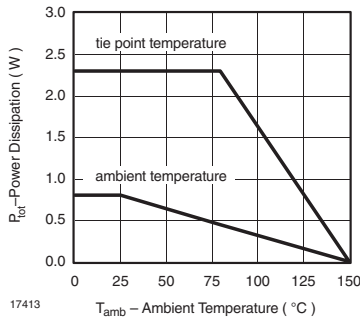

Figure 3. Power Dissipation vs. Ambient Temperature

## DO-219AB (SMF) Package Dimension see Package Section

# BZD27C3V6P to BZD27C200P

Vishay Semiconductors

---



## Zener Diodes

### Features

- Glass passivated junction
- High reliability
- Voltage range 10 V to 270 V
- Fits onto 5 mm SMD footpads
- Wave and reflow solderable

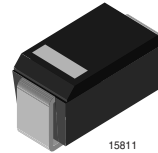

### Applications

Voltage stabilization

### Mechanical Data

**Case:** DO-214AC

**Weight:** approx. 77 mg

**Packaging Codes/Options:**

TR / 1.5 k 7 " reel

TR3 / 6 k 13 " reel 6 k/box

### Absolute Maximum Ratings

$T_{amb} = 25\text{ }^{\circ}\text{C}$ , unless otherwise specified

Parameter	Test condition	Symbol	Value	Unit
Power dissipation	$R_{thJA} < 25\text{ K/W}$ , $T_{amb} = 100\text{ }^{\circ}\text{C}$	$P_{diss}$	3	W
	$R_{thJA} < 100\text{ K/W}$ , $T_{amb} = 50\text{ }^{\circ}\text{C}$	$P_{diss}$	1.25	W
Non repetitive peak surge power dissipation	$t_p = 100\text{ }\mu\text{s}$ sq.pulse, $T_j = 25\text{ }^{\circ}\text{C}$ prior to surge	$P_{ZSM}$	600	W
Junction temperature		$T_j$	150	$^{\circ}\text{C}$
Storage temperature range		$T_{stg}$	- 65 to + 150	$^{\circ}\text{C}$

### Thermal Characteristics

$T_{amb} = 25\text{ }^{\circ}\text{C}$ , unless otherwise specified

Parameter	Test condition	Symbol	Value	Unit
Junction lead		$R_{thJL}$	25	K/W
Junction ambient	mounted on epoxy-glass hard tissue, Fig. 1a	$R_{thJA}$	150	K/W
	mounted on epoxy-glass hard tissue, Fig. 1b	$R_{thJA}$	125	K/W
	mounted on Al-oxid-ceramic ( $\text{Al}_2\text{O}_3$ ), Fig. 1b	$R_{thJA}$	100	K/W

### Electrical Characteristics

T<sub>amb</sub> = 25 °C, unless otherwise specified

Parameter	Test condition	Symbol	Min	Typ.	Max	Unit
Forward voltage	I <sub>F</sub> = 0.5 A	V <sub>F</sub>			1.2	V

### Electrical Characteristics

BZG03C...

Partnumber	Zener Voltage Range			Dynamic Resistance		Test Current	Temperature Coefficient of Zener Voltage		Reverse Leakage Current	
	V <sub>Z</sub> @ I <sub>ZT</sub>			r <sub>zj</sub> and TK <sub>VZ</sub> @ I <sub>ZT</sub>			I <sub>ZT</sub>	TK <sub>VZ</sub> @ I <sub>ZT</sub>		I <sub>R</sub> @ V <sub>R</sub>
	V			Ω		mA	%K		μA	V
	min	typ	max	typ	max		min	max	max	
BZG03C10	9.4	10	10.6	2	4	50	0.05	0.09	10	7.5
BZG03C11	10.4	11	11.6	4	7	50	0.05	0.1	4	8.2
BZG03C12	11.4	12	12.7	4	7	50	0.05	0.1	3	9.1
BZG03C13	12.4	13	14.1	5	10	50	0.05	0.1	2	10
BZG03C15	13.8	15	15.6	5	10	50	0.05	0.1	1	11
BZG03C16	15.3	16	17.1	6	15	25	0.06	0.11	1	12
BZG03C18	16.8	18	19.1	6	15	25	0.06	0.11	1	13
BZG03C20	18.8	20	21.2	6	15	25	0.06	0.11	1	15
BZG03C22	20.8	22	23.3	6	15	25	0.06	0.11	1	16
BZG03C24	22.8	24	25.6	7	15	25	0.06	0.11	1	18
BZG03C27	25.1	27	28.9	7	15	25	0.06	0.11	1	20
BZG03C30	28	30	32	8	15	25	0.06	0.11	1	22
BZG03C33	31	33	35	8	15	25	0.06	0.11	1	24
BZG03C36	34	36	38	21	40	10	0.06	0.11	1	27
BZG03C39	37	39	41	21	40	10	0.06	0.11	1	30
BZG03C43	40	43	46	24	45	10	0.07	0.12	1	33
BZG03C47	44	47	50	24	45	10	0.07	0.12	1	36
BZG03C51	48	51	54	25	60	10	0.07	0.12	1	39
BZG03C56	52	56	60	25	60	10	0.07	0.12	1	43
BZG03C62	58	62	66	25	80	10	0.08	0.13	1	47
BZG03C68	64	68	72	25	80	10	0.08	0.13	1	51
BZG03C75	70	75	79	30	100	10	0.08	0.13	1	56
BZG03C82	77	82	87	30	100	10	0.08	0.13	1	62
BZG03C91	85	91	96	60	200	5	0.09	0.13	1	68
BZG03C100	94	100	106	60	200	5	0.09	0.13	1	75
BZG03C110	104	110	116	80	250	5	0.09	0.13	1	82
BZG03C120	114	120	127	80	250	5	0.09	0.13	1	91
BZG03C130	124	130	141	110	300	5	0.09	0.13	1	100
BZG03C150	138	150	156	130	300	5	0.09	0.13	1	110
BZG03C160	158	160	171	150	350	5	0.09	0.13	1	120
BZG03C180	168	180	191	180	400	5	0.09	0.13	1	130
BZG03C200	188	200	212	200	500	5	0.09	0.13	1	150
BZG03C220	208	220	233	350	750	2	0.09	0.13	1	160
BZG03C240	228	240	256	400	850	2	0.09	0.13	1	180
BZG03C270	251	270	289	450	1000	2	0.09	0.13	1	200

## Typical Characteristics ( $T_{amb} = 25\text{ }^{\circ}\text{C}$ unless otherwise specified)

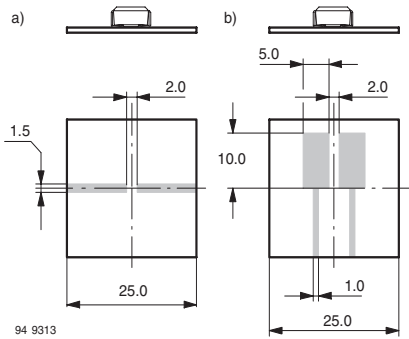

Figure 1. Boards for  $R_{thJA}$  definition (copper overlay  $35\mu$ )

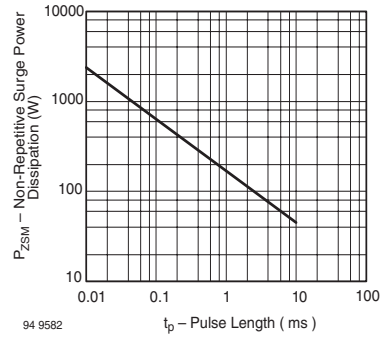

Figure 4. Non Repetitive Surge Power Dissipation vs. Pulse Length

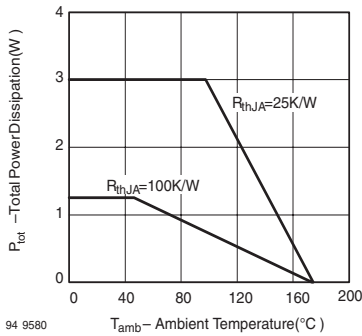

Figure 2. Total Power Dissipation vs. Ambient Temperature

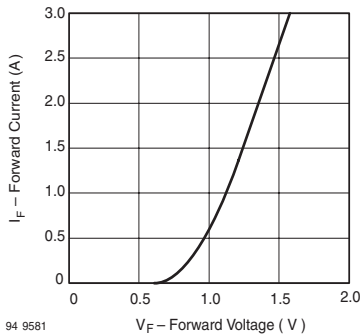

Figure 3. Forward Current vs. Forward Voltage



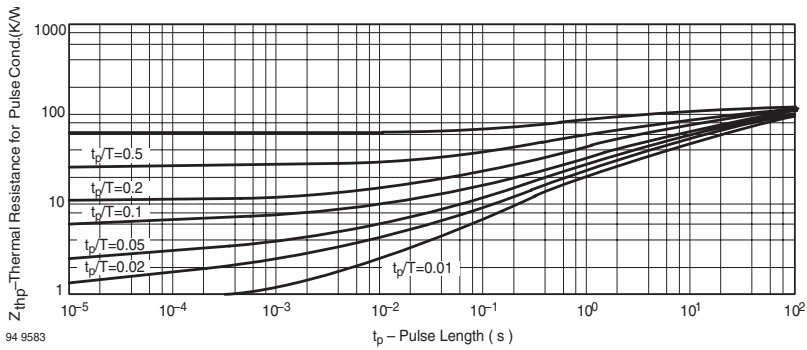

Figure 5. Thermal Response

**DO-214AC Package Dimension**  
see Package Section

## Zener Diodes with Surge Current Specification

### Features

- Glass passivated junction
- High reliability
- Stand-off Voltage range 8.2 V to 220 V
- Excellent clamping capability
- Fast response time (typ.  $\leq 1$  ps from 0 to  $V_{Zmin}$ )

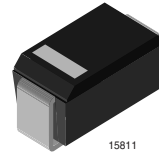

### Applications

Protection from high voltage, high energy transients

### Mechanical Data

**Case:** DO-214AC

**Weight:** approx. 77 mg

**Packaging Codes/Options:**

TR / 1.5 k 7 " reel

TR3 / 6 k 13 " reel 6 k/box

### Absolute Maximum Ratings

$T_{amb} = 25$  °C, unless otherwise specified

Parameter	Test condition	Symbol	Value	Unit
Power dissipation	$R_{thJA} < 25$ K/W, $T_{amb} = 100$ °C	$P_{diss}$	3	W
	$R_{thJA} < 100$ K/W, $T_{amb} = 50$ °C	$P_{diss}$	1.25	W
Non repetitive peak surge power dissipation	$t_p = 10/1000$ $\mu$ s sq.pulse, $T_j = 25$ °C prior to surge	$P_{ZSM}$	300	W
Peak forward surge current	10 ms single half sine wave	$I_{FSM}$	50	A
Junction temperature		$T_j$	150	°C
Storage temperature range		$T_{stg}$	- 65 to + 150	°C

### Thermal Characteristics

$T_{amb} = 25$  °C, unless otherwise specified

Parameter	Test condition	Symbol	Value	Unit
Junction lead		$R_{thJL}$	25	K/W
Junction ambient	mounted on epoxy-glass hard tissue, Fig. 1a	$R_{thJA}$	150	K/W
	mounted on epoxy-glass hard tissue, Fig. 1b	$R_{thJA}$	125	K/W
	mounted on Al-oxid-ceramic ( $Al_2O_3$ ), Fig. 1b	$R_{thJA}$	100	K/W

### Electrical Characteristics

T<sub>amb</sub> = 25 °C, unless otherwise specified

Parameter	Test condition	Symbol	Min	Typ.	Max	Unit
Forward voltage	I <sub>F</sub> = 0.5 A	V <sub>F</sub>			1.2	V

### Electrical Characteristics

Partnumber	Standoff Voltage		Breakdown Voltage		TK <sub>VZ</sub> @ I <sub>R</sub>		Clamping Voltage		Junction Capacitance C <sub>J</sub> @ V <sub>R</sub> = 0 V, f = 1 MHz
	V <sub>R</sub>	I <sub>R</sub>	V <sub>(BR)</sub> @ I <sub>R</sub>				V <sub>CL(R)</sub> @ I <sub>PP</sub>	@ I <sub>ZT</sub>	
	V	μA	V	mA	%K		V <sup>*)</sup>	A <sup>*)</sup>	pF
BZG04-8V2	8.2	20	9.4	50	0.05	0.09	14.8	20.3	1200
BZG04-9V1	9.1	5	10.4	50	0.05	0.1	15.7	19.1	1100
BZG04-10	10	5	11.4	50	0.05	0.1	17	17.7	1000
BZG04-11	11	5	12.4	50	0.05	0.1	18.9	15.9	850
BZG04-12	12	5	13.8	50	0.05	0.1	20.9	14.4	815
BZG04-13	13	5	15.3	25	0.06	0.11	22.9	13.1	785
BZG04-15	15	5	16.8	25	0.06	0.11	25.6	11.7	710
BZG04-16	16	5	18.8	25	0.06	0.11	28.4	10.6	655
BZG04-18	18	5	20.8	25	0.06	0.11	31	9.7	610
BZG04-20	20	5	22.8	25	0.06	0.11	33.8	8.9	570
BZG04-22	22	5	25.1	25	0.06	0.11	38.1	7.9	545
BZG04-24	24	5	28	25	0.06	0.11	42.2	7.1	505
BZG04-27	27	5	31	25	0.06	0.11	46.2	6.5	475
BZG04-30	30	5	34	10	0.06	0.11	50.1	6.0	450
BZG04-33	33	5	37	10	0.06	0.11	54.1	5.5	420
BZG04-36	36	5	40	10	0.07	0.12	60.7	4.9	390
BZG04-39	39	5	44	10	0.07	0.12	65.5	4.6	370
BZG04-43	43	5	48	10	0.07	0.12	70.8	4.2	350
BZG04-47	47	5	52	10	0.07	0.12	78.6	3.8	330
BZG04-51	51	5	58	10	0.08	0.13	86.5	3.5	310
BZG04-56	56	5	64	10	0.08	0.13	94.4	3.2	291
BZG04-62	62	5	70	10	0.08	0.13	103.5	2.9	280
BZG04-68	68	5	77	10	0.08	0.13	114	2.6	275
BZG04-75	75	5	85	5	0.09	0.13	126	2.4	260
BZG04-82	82	5	94	5	0.09	0.13	139	2.2	250
BZG04-91	91	5	104	5	0.09	0.13	152	2.0	243
BZG04-100	100	5	114	5	0.09	0.13	167	1.8	170
BZG04-110	110	5	124	5	0.09	0.13	185	1.6	153
BZG04-120	120	5	138	5	0.09	0.13	204	1.5	150
BZG04-130	130	5	153	5	0.09	0.13	224	1.3	145
BZG04-150	150	5	168	5	0.09	0.13	249	1.2	140
BZG04-160	160	5	188	5	0.09	0.13	276	1.1	135
BZG04-180	180	5	208	2	0.09	0.13	305	1.0	131
BZG04-200	200	5	228	2	0.09	0.13	336	0.9	122
BZG04-220	220	5	251	2	0.09	0.13	380	0.8	120

<sup>\*)</sup> 10/1000 μs pulse

## Typical Characteristics ( $T_{amb} = 25\text{ }^{\circ}\text{C}$ unless otherwise specified)

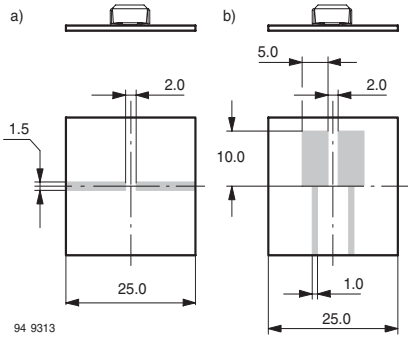

Figure 1. Boards for  $R_{thJA}$  definition (copper overlay  $35\mu$ )

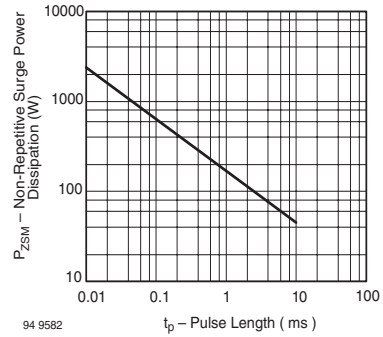

Figure 4. Non Repetitive Surge Power Dissipation vs. Pulse Length

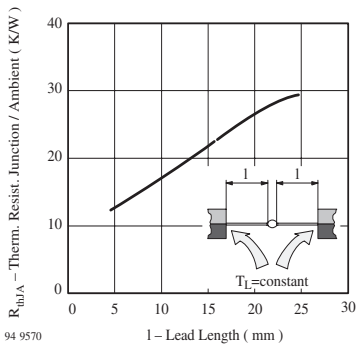

Figure 2. Typ. Thermal Resistance vs. Lead Length

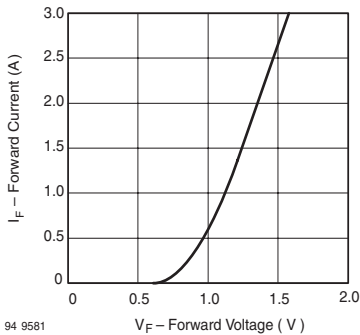
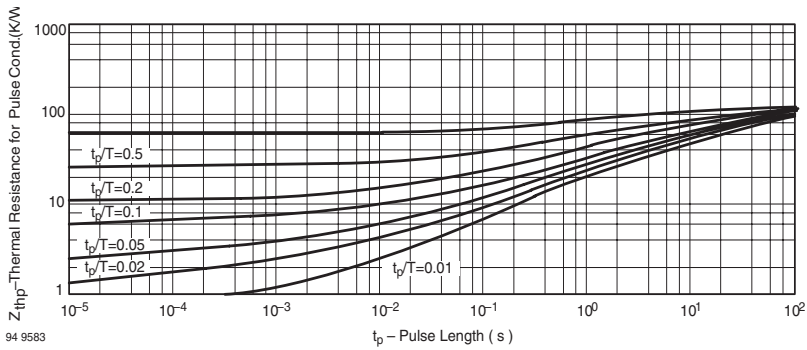

Figure 3. Forward Current vs. Forward Voltage



94 9583

Figure 5. Thermal Response

**DO-214AC Package Dimension**  
see Package Section

## Zener Diodes

### Features

- Glass passivated junction
- High reliability
- Voltage range 3.3 V to 100 V
- Fits onto 5 mm SMD footpads
- Wave and reflow solderable

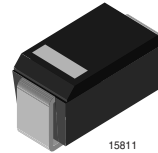

### Applications

Voltage stabilization

### Mechanical Data

**Case:** DO-214AC

**Weight:** approx. 77 mg

**Packaging Codes/Options:**

TR / 1.5 k 7 " reel

TR3 / 6 k 13 " reel 6 k/box

### Absolute Maximum Ratings

$T_{amb} = 25\text{ }^{\circ}\text{C}$ , unless otherwise specified

Parameter	Test condition	Symbol	Value	Unit
Power dissipation	$R_{thJA} < 30\text{ K/W}$ , $T_{amb} = 60\text{ }^{\circ}\text{C}$	$P_{diss}$	3	W
	$R_{thJA} < 100\text{ K/W}$ , $T_{amb} = 25\text{ }^{\circ}\text{C}$	$P_{diss}$	1.25	W
Non repetitive peak surge power dissipation	$t_p = 100\text{ }\mu\text{s}$ sq.pulse, $T_j = 25\text{ }^{\circ}\text{C}$ prior to surge	$P_{ZSM}$	60	W
Junction temperature		$T_j$	150	$^{\circ}\text{C}$
Storage temperature range		$T_{stg}$	- 65 to + 150	$^{\circ}\text{C}$

### Thermal Characteristics

$T_{amb} = 25\text{ }^{\circ}\text{C}$ , unless otherwise specified

Parameter	Test condition	Symbol	Value	Unit
Junction lead		$R_{thJL}$	30	K/W
Junction ambient	mounted on epoxy-glass hard tissue, Fig. 1a	$R_{thJA}$	150	K/W
	mounted on epoxy-glass hard tissue, Fig. 1b	$R_{thJA}$	125	K/W
	mounted on Al-oxid-ceramic ( $\text{Al}_2\text{O}_3$ ), Fig. 1b	$R_{thJA}$	100	K/W

### Electrical Characteristics

T<sub>amb</sub> = 25 °C, unless otherwise specified

Parameter	Test condition	Symbol	Min	Typ.	Max	Unit
Forward voltage	I <sub>F</sub> = 0.2 A	V <sub>F</sub>			1.2	V

### Electrical Characteristics

Partnumber	Zener Voltage			Maximum Dynamic Resistance		Test Current	Temp. Coefficient of Zener Voltage		Test Current	Max. Reverse Leakage Current	Reverse Voltage
	V <sub>Z</sub> @ I <sub>ZT</sub>			r <sub>zT</sub> @ I <sub>ZT</sub>	r <sub>zK</sub> @ I <sub>ZK</sub>		@ I <sub>ZT</sub>				
	min	typ	max	Ω		mA	%K		mA	μA	V
BZG05C3V3	3.1	3.3	3.5	20	400	80	-0.08	-0.05	1	40	1
BZG05C3V6	3.4	3.6	3.8	20	500	60	-0.08	-0.05	1	20	1
BZG05C3V9	3.7	3.9	4.1	15	500	60	-0.07	-0.02	1	10	1
BZG05C4V3	4.0	4.3	4.6	13	500	50	-0.07	-0.01	1	3	1
BZG05C4V7	4.4	4.7	5.0	13	600	45	-0.03	0.04	1	3	1
BZG05C5V1	4.8	5.1	5.4	10	500	45	-0.01	0.04	1	1	1.5
BZG05C5V6	5.2	5.6	6.0	7	400	45	0	0.045	1	1	2
BZG05C6V2	5.8	6.2	6.6	4	300	35	0.01	0.055	1	1	3
BZG05C6V8	6.4	6.8	7.2	3.5	300	35	0.015	0.06	1	1	4
BZG05C7V5	7.0	7.5	7.9	3	200	35	0.02	0.065	0.5	1	4.5
BZG05C8V2	7.7	8.2	8.7	5	200	25	0.03	0.07	0.5	1	6.2
BZG05C9V1	8.5	9.1	9.6	5	200	25	0.035	0.075	0.5	1	6.8
BZG05C10	9.4	10	10.6	7	200	25	0.04	0.08	0.5	0.5	7
BZG05C11	10.4	11	11.6	8	300	20	0.045	0.08	0.5	0.5	8.2
BZG05C12	11.4	12	12.7	9	350	20	0.045	0.085	0.5	0.5	9.1
BZG05C13	12.4	13	14.1	10	400	20	0.05	0.085	0.5	0.5	10
BZG05C15	13.8	15	15.6	15	500	15	0.055	0.09	0.5	0.5	11
BZG05C16	15.3	16	17.1	15	500	15	0.055	0.09	0.5	0.5	12
BZG05C18	16.8	18	19.1	20	500	15	0.06	0.09	0.5	0.5	13
BZG05C20	18.8	20	21.2	24	600	10	0.06	0.09	0.5	0.5	15
BZG05C22	20.8	22	23.3	25	600	10	0.06	0.095	0.5	0.5	16
BZG05C24	22.8	24	25.6	25	600	10	0.06	0.095	0.5	0.5	18
BZG05C27	25.1	27	28.9	30	750	8	0.06	0.095	0.25	0.5	20
BZG05C30	28	30	32	30	1000	8	0.06	0.095	0.25	0.5	22
BZG05C33	31	33	35	35	1000	8	0.06	0.095	0.25	0.5	24
BZG05C36	34	36	38	40	1000	8	0.06	0.095	0.25	0.5	27
BZG05C39	37	39	41	50	1000	6	0.06	0.095	0.25	0.5	30
BZG05C43	40	43	46	50	1000	6	0.06	0.095	0.25	0.5	33
BZG05C47	44	47	50	90	1500	4	0.06	0.095	0.25	0.5	36
BZG05C51	48	51	54	115	1500	4	0.06	0.095	0.25	0.5	39
BZG05C56	52	56	60	120	2000	4	0.06	0.095	0.25	0.5	43
BZG05C62	58	62	66	125	2000	4	0.06	0.095	0.25	0.5	47
BZG05C68	64	68	72	130	2000	4	0.06	0.095	0.25	0.5	51
BZG05C75	70	75	79	135	2000	4	0.06	0.095	0.25	0.5	56
BZG05C82	77	82	87	200	3000	2.7	0.06	0.095	0.25	0.5	62
BZG05C91	85	91	96	250	3000	2.7	0.06	0.095	0.25	0.5	68
BZG05C100	95	105	106	350	3000	2.7	0.06	0.095	0.25	0.5	75

## Typical Characteristics ( $T_{amb} = 25\text{ }^{\circ}\text{C}$ unless otherwise specified)

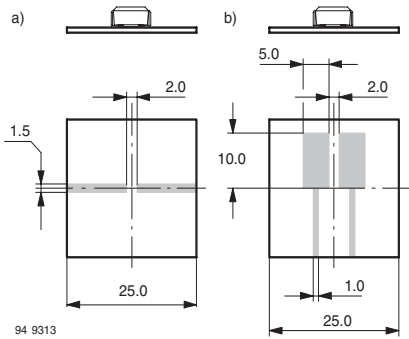

Figure 1. Boards for  $R_{thJA}$  definition (copper overlay  $35\mu$ )

## DO-214AC(T) Package Dimension see Package Section



# BZG05C-Series

Vishay Semiconductors

---



## Small Signal Zener Diodes

### Features

- Saving space
- Hermetic sealed parts
- Electrical data identical with the devices BZT55..Series / TZM..Series
- Fits onto SOD-323 / SOD-110 footprints
- Very sharp reverse characteristic
- Low reverse current level
- Very high stability
- Low noise
- Available with tighter tolerances

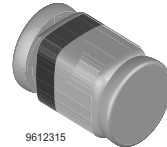

### Applications

Voltage stabilization

### Mechanical Data

**Case:** MicroMELF

**Weight:** approx. 12 mg

**Packaging codes/options:**

TR / 2.5 k per 7" reel, 12.5 k/box

TR3 / 10 k per 13" reel, 10 k/box

### Absolute Maximum Ratings

$T_{amb} = 25\text{ }^{\circ}\text{C}$ , unless otherwise specified

Parameter	Test condition	Symbol	Value	Unit
Power dissipation	$R_{thJA} \leq 300\text{ K/W}$	$P_V$	500	mW
Z-current		$I_Z$	$P_V/V_Z$	mA
Junction temperature		$T_j$	175	$^{\circ}\text{C}$
Storage temperature range		$T_{stg}$	- 65 to + 175	$^{\circ}\text{C}$

### Thermal Characteristics

$T_{amb} = 25\text{ }^{\circ}\text{C}$ , unless otherwise specified

Parameter	Test condition	Symbol	Value	Unit
Junction ambient	mounted on epoxy-glass hard tissue, Fig. 1	$R_{thJA}$	500	K/W
Junction tie point	35 $\mu\text{m}$ copper clad, 0.9 $\text{mm}^2$ copper area per electrode	$R_{thJL}$	300	K/W

### Electrical Characteristics

$T_{amb} = 25\text{ }^{\circ}\text{C}$ , unless otherwise specified

Parameter	Test condition	Symbol	Min	Typ.	Max	Unit
Forward voltage	$I_F = 200\text{ mA}$	$V_F$			1.5	V

### Electrical Characteristics

#### BZM55C..

Partnumber	Zener Voltage Range <sup>1)</sup>		Dynamic Resistance		Test Current	Temperature Coefficient		Test Current	Reverse Leakage Current		
	$V_Z @ I_{ZT}$		$r_{zT} @ I_{ZT}$ f = 1k Hz	$r_{zK} @ I_{ZK}$ f = 1k Hz	$I_{ZT}$	TK <sub>VZ</sub>		$I_{ZK}$	$I_R @ T_{amb} = 25\text{ °C}$	$I_R @ T_{amb} = 150\text{ °C}$	$@ V_R$
	min	max	Ω		mA	min	max	mA	μA		V
BZM55C2V4	2.28	2.56	< 85	< 600	5	-0.09	-0.06	1	< 50	< 100	1
BZM55C2V7	2.5	2.9	< 85	< 600	5	-0.09	-0.06	1	< 10	< 50	1
BZM55C3V0	2.8	3.2	< 90	< 600	5	-0.08	-0.05	1	< 4	< 40	1
BZM55C3V3	3.1	3.5	< 90	< 600	5	-0.08	-0.05	1	< 2	< 40	1
BZM55C3V6	3.4	3.8	< 90	< 600	5	-0.08	-0.05	1	< 2	< 40	1
BZM55C3V9	3.7	4.1	< 90	< 600	5	-0.08	-0.05	1	< 2	< 40	1
BZM55C4V3	4	4.6	< 90	< 600	5	-0.06	-0.03	1	< 1	< 20	1
BZM55C4V7	4.4	5	< 80	< 600	5	-0.05	0.02	1	< 0.5	< 10	1
BZM55C5V1	4.8	5.4	< 60	< 550	5	-0.02	0.02	1	< 0.1	< 2	1
BZM55C5V6	5.2	6	< 40	< 450	5	-0.05	0.05	1	< 0.1	< 2	1
BZM55C6V2	5.8	6.6	< 10	< 200	5	0.03	0.06	1	< 0.1	< 2	2
BZM55C6V8	6.4	7.2	< 8	< 150	5	0.03	0.07	1	< 0.1	< 2	3
BZM55C7V5	7	7.9	< 7	< 50	5	0.03	0.07	1	< 0.1	< 2	5
BZM55C8V2	7.7	8.7	< 7	< 50	5	0.03	0.08	1	< 0.1	< 2	6.2
BZM55C9V1 *	8.5	9.6	< 10	< 50	5	0.03	0.09	1	< 0.1	< 2	6.8
BZM55C10 *	9.4	0.6	< 15	< 70	5	0.03	0.1	1	< 0.1	< 2	7.5
BZM55C11 *	10.4	11.6	< 20	< 70	5	0.03	0.11	1	< 0.1	< 2	8.2
BZM55C12 *	11.4	12.7	< 20	< 90	5	0.03	0.11	1	< 0.1	< 2	9.1
BZM55C13 *	12.4	14.1	< 26	< 110	5	0.03	0.11	1	< 0.1	< 2	10
BZM55C15 *	13.8	15.6	< 30	< 110	5	0.03	0.11	1	< 0.1	< 2	11
BZM55C16 *	15.3	17.1	< 40	< 170	5	0.03	0.11	1	< 0.1	< 2	12
BZM55C18 *	16.8	19.1	< 50	< 170	5	0.03	0.11	1	< 0.1	< 2	13
BZM55C20 *	18.8	21.2	< 55	< 220	5	0.03	0.11	1	< 0.1	< 2	15
BZM55C22 *	20.8	23.3	< 55	< 220	5	0.04	0.12	1	< 0.1	< 2	16
BZM55C24 *	22.8	25.6	< 80	< 220	5	0.04	0.12	1	< 0.1	< 2	18
BZM55C27 *	25.1	28.9	< 80	< 220	5	0.04	0.12	1	< 0.1	< 2	20
BZM55C30 *	28	32	< 80	< 220	5	0.04	0.12	1	< 0.1	< 2	22
BZM55C33 *	31	35	< 80	< 220	5	0.04	0.12	1	< 0.1	< 2	24
BZM55C36 *	34	38	< 80	< 220	5	0.04	0.12	1	< 0.1	< 2	27
BZM55C39 *	37	41	< 90	< 500	2.5	0.04	0.12	0.5	< 0.1	< 5	30
BZM55C43 *	40	46	< 90	< 600	2.5	0.04	0.12	0.5	< 0.1	< 5	33
BZM55C47 *	44	50	110	< 700	2.5	0.04	0.12	0.5	< 0.1	< 5	36
BZM55C51 *	48	54	125	< 700	2.5	0.04	0.12	0.5	< 0.1	< 10	39
BZM55C56 *	52	60	135	< 1000	2.5	0.04	0.12	0.5	< 0.1	< 10	43
BZM55C62 *	58	66	150	< 1000	2.5	0.04	0.12	0.5	< 0.1	< 10	47
BZM55C68 *	64	72	200	< 1000	2.5	0.04	0.12	0.5	< 0.1	< 10	51
BZM55C75 *	70	79	250	< 1500	2.5	0.04	0.12	0.5	< 0.1	< 10	56

<sup>1)</sup>  $t_p \leq 10\text{ ms}$ ,  $T/t_p > 1000$ .

<sup>2)</sup> Additional measurement of Voltage group 9V1 to 75 at 95 %  $V_{zmin} \leq 35\text{ nA}$  at  $T_j 25\text{ °C}$

### Electrical Characteristics

#### BZM55B..

Partnumber	Zener Voltage Range <sup>1)</sup>		Dynamic Resistance		Test Current	Temperature Coefficient		Test Current	Reverse Leakage Current		
	$V_Z @ I_{ZT}$		$r_{zT} @ I_{ZT}$ f = 1k Hz	$r_{zK} @ I_{ZK}$ f = 1k Hz		$I_{ZT}$	TK <sub>VZ</sub>		$I_{R} @ T_{amb} = 25^{\circ}C$	$I_{R} @ T_{amb} = 150^{\circ}C$	$@ V_R$
	min	max	Ω		mA	min	max	mA	μA	V	
BZM55B2V4	2.35	2.45	< 85	< 600	5	-0.09	-0.06	1	< 50	< 100	1
BZM55B2V7	2.64	2.76	< 85	< 600	5	-0.09	-0.06	1	< 10	< 50	1
BZM55B3V0	2.94	3.06	< 90	< 600	5	-0.08	-0.05	1	< 4	< 40	1
BZM55B3V3	3.24	3.36	< 90	< 600	5	-0.08	-0.05	1	< 2	< 40	1
BZM55B3V6	3.52	3.68	< 90	< 600	5	-0.08	-0.05	1	< 2	< 40	1
BZM55B3V9	3.82	3.98	< 90	< 600	5	-0.08	-0.05	1	< 2	< 40	1
BZM55B4V3	4.22	4.38	< 90	< 600	5	-0.06	-0.03	1	< 1	< 20	1
BZM55B4V7	4.6	4.80	< 80	< 600	5	-0.05	0.02	1	< 0.5	< 10	1
BZM55B5V1	5	5.20	< 60	< 550	5	-0.02	0.02	1	< 0.1	< 2	1
BZM55B5V6	5.48	5.72	< 40	< 450	5	-0.05	0.05	1	< 0.1	< 2	1
BZM55B6V2	6.08	6.32	< 10	< 200	5	0.03	0.06	1	< 0.1	< 2	2
BZM55B6V8	6.66	6.94	< 8	< 150	5	0.03	0.07	1	< 0.1	< 2	3
BZM55B7V5	7.35	7.65	< 7	< 50	5	0.03	0.07	1	< 0.1	< 2	5
BZM55B8V2	8.04	8.36	< 7	< 50	5	0.03	0.08	1	< 0.1	< 2	6.2
BZM55B9V1 *	8.92	9.28	< 10	< 50	5	0.03	0.09	1	< 0.1	< 2	6.8
BZM55B10 *	9.8	10.20	< 15	< 70	5	0.03	0.1	1	< 0.1	< 2	7.5
BZM55B11 *	10.78	11.22	< 20	< 70	5	0.03	0.11	1	< 0.1	< 2	8.2
BZM55B12 *	11.76	12.24	< 20	< 90	5	0.03	0.11	1	< 0.1	< 2	9.1
BZM55B13 *	12.74	13.26	< 26	< 110	5	0.03	0.11	1	< 0.1	< 2	10
BZM55B15 *	14.7	15.30	< 30	< 110	5	0.03	0.11	1	< 0.1	< 2	11
BZM55B16 *	15.7	16.30	< 40	< 170	5	0.03	0.11	1	< 0.1	< 2	12
BZM55B18 *	17.64	18.36	< 50	< 170	5	0.03	0.11	1	< 0.1	< 2	13
BZM55B20 *	19.6	20.40	< 55	< 220	5	0.03	0.11	1	< 0.1	< 2	15
BZM55B22 *	21.55	22.45	< 55	< 220	5	0.04	0.12	1	< 0.1	< 2	16
BZM55B24 *	23.5	24.5	< 80	< 220	5	0.04	0.12	1	< 0.1	< 2	18
BZM55B27 *	26.4	27.6	< 80	< 220	5	0.04	0.12	1	< 0.1	< 2	20
BZM55B30 *	29.4	30.6	< 80	< 220	5	0.04	0.12	1	< 0.1	< 2	22
BZM55B33 *	32.4	33.6	< 80	< 220	5	0.04	0.12	1	< 0.1	< 2	24
BZM55B36 *	35.3	36.7	< 80	< 220	5	0.04	0.12	1	< 0.1	< 2	27
BZM55B39 *	38.2	39.8	< 90	< 500	2.5	0.04	0.12	1	< 0.1	< 5	30
BZM55B43 *	42.1	43.9	< 90	< 600	2.5	0.04	0.12	0.5	< 0.1	< 5	33
BZM55B47 *	46.1	47.9	< 110	< 700	2.5	0.04	0.12	0.5	< 0.1	< 5	36
BZM55B51 *	50	52.0	< 125	< 700	2.5	0.04	0.12	0.5	< 0.1	< 10	39
BZM55B56 *	54.9	57.1	< 135	< 1000	2.5	0.04	0.12	0.5	< 0.1	< 10	43
BZM55B62 *	60.8	63.2	< 150	< 1000	2.5	0.04	0.12	0.5	< 0.1	< 10	47
BZM55B68 *	66.6	69.4	< 200	< 1000	2.5	0.04	0.12	0.5	< 0.1	< 10	51
BZM55C75 *	73.5	76.5	< 250	< 1500	2.5	0.04	0.12	0.5	< 0.1	< 10	56

<sup>1)</sup>  $t_p \leq 10$  ms,  $T/t_p > 1000$ .

<sup>\*)</sup> Additional measurement of Voltage group 9V1 to 75 at 95 %  $V_{zmin} \leq 35$  nA at  $T_j 25^{\circ}C$

## Typical Characteristics ( $T_{amb} = 25\text{ }^{\circ}\text{C}$ unless otherwise specified)

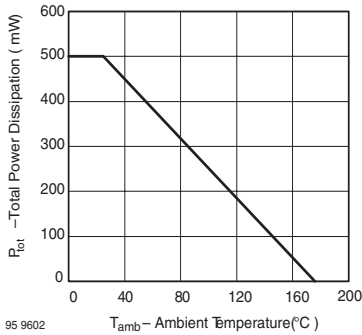

Figure 1. Total Power Dissipation vs. Ambient Temperature

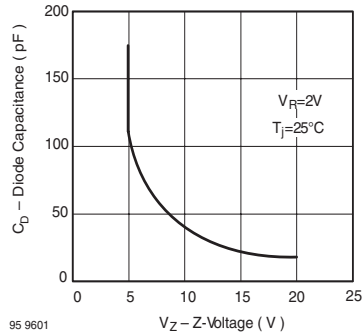

Figure 4. Diode Capacitance vs. Z-Voltage

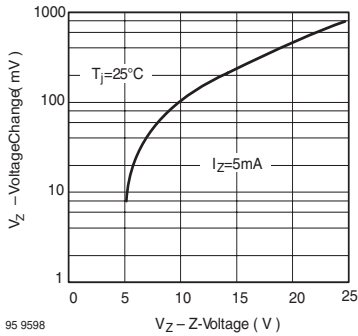

Figure 2. Typical Change of Working Voltage under Operating Conditions at  $T_{amb}=25\text{ }^{\circ}\text{C}$

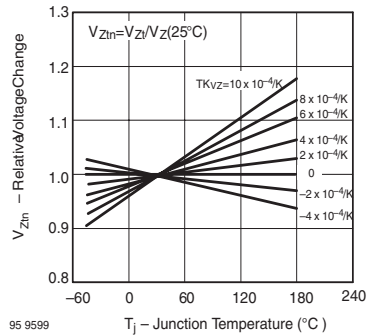

Figure 5. Typical Change of Working Voltage vs. Junction Temperature

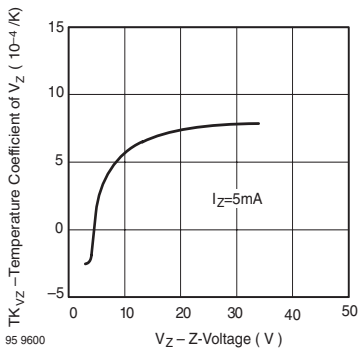

Figure 3. Temperature Coefficient of  $V_Z$  vs. Z-Voltage

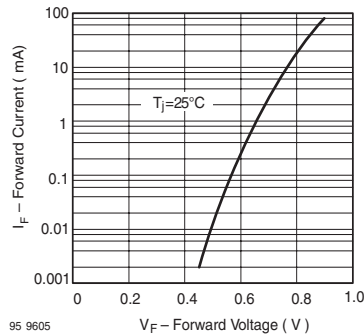

Figure 6. Forward Current vs. Forward Voltage

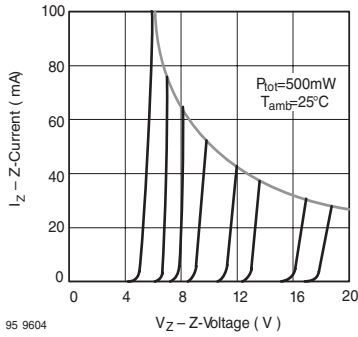

Figure 7. Z-Current vs. Z-Voltage

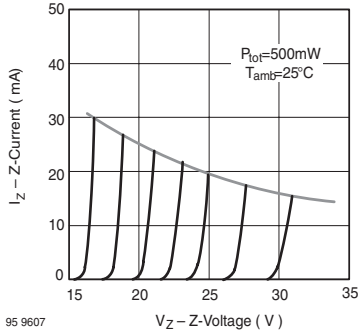

Figure 8. Z-Current vs. Z-Voltage

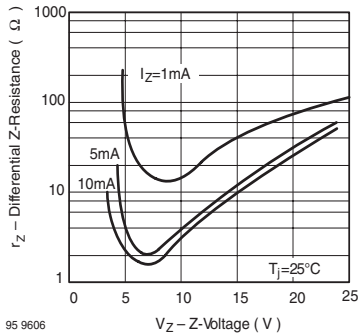

Figure 9. Differential Z-Resistance vs. Z-Voltage

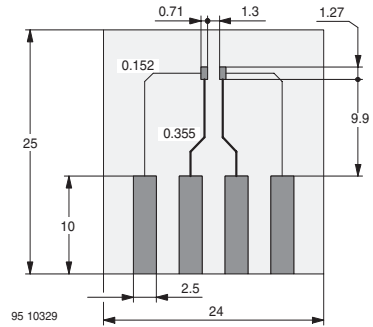

Figure 10. Board for  $R_{thJA}$  definition (in mm)

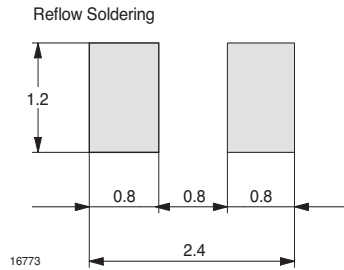

Figure 11. Recommended foot pads (in mm)

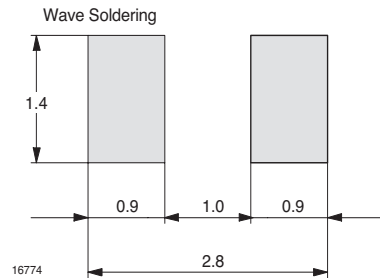

Figure 12. Recommended foot pads (in mm)

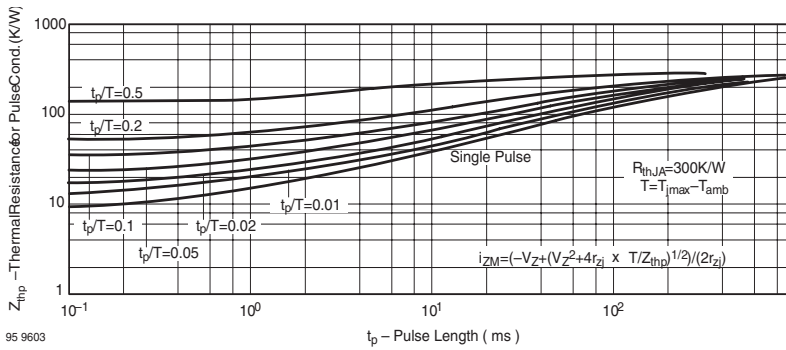

Figure 13. Thermal Response

**MicroMELF Package Dimension**  
 see Package Section

## Zener Diodes with Surge Current Specification

### Features

- Glass passivated junction
- Hermetically sealed package
- Clamping time in picoseconds

### Applications

Medium power voltage regulators and medium power transient suppression circuits

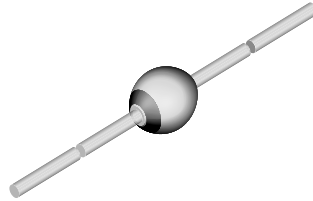

949539

### Mechanical Data

**Case:** SOD-57 Sintered glass case

**Weight:** approx. 369 mg

**Packaging Codes/Options:**

TAP / 5 k Ammopack (52 mm tape) / 25 k/box

TR / 5 k 10" reel

### Absolute Maximum Ratings

$T_{amb} = 25\text{ }^{\circ}\text{C}$ , unless otherwise specified

Parameter	Test condition	Symbol	Value	Unit
Power dissipation	$I = 10\text{ mm}$ , $T_L = 25\text{ }^{\circ}\text{C}$	$P_V$	3.25	W
	$T_{amb} = 25\text{ }^{\circ}\text{C}$	$P_V$	1.3	W
Repetitive peak reverse power dissipation		$P_{ZRM}$	10	W
Non repetitive peak surge power dissipation	$t_p = 100\text{ }\mu\text{s}$ , $T_j = 25\text{ }^{\circ}\text{C}$	$P_{ZSM}$	600	W
Junction temperature		$T_j$	175	$^{\circ}\text{C}$
Storage temperature range		$T_{stg}$	- 65 to + 175	$^{\circ}\text{C}$

### Thermal Characteristics

$T_{amb} = 25\text{ }^{\circ}\text{C}$ , unless otherwise specified

Parameter	Test condition	Symbol	Value	Unit
Junction ambient	$I = 10\text{ mm}$ , $T_L = \text{constant}$	$R_{thJA}$	46	K/W
	on PC board with spacing 25 mm	$R_{thJA}$	100	K/W

### Electrical Characteristics

$T_{amb} = 25\text{ }^{\circ}\text{C}$ , unless otherwise specified

Parameter	Test condition	Symbol	Min	Typ.	Max	Unit
Forward voltage	$I_F = 0.5\text{ A}$	$V_F$			1.2	V



### Electrical Characteristics

BZT03C...

Partnumber	Zener Voltage Range			Dynamic Resistance		Test Current	Temperature Coefficient of Zener Voltage		Reverse Leakage Current		Clamping		Stand-off	
	$V_Z @ I_{ZT}$			$r_{zj}$ and $TK_{VZ} @ I_Z$			$I_{ZT}$	$TC_{VZ} @ I_{ZT}$		$I_R @ V_R$		$V_{(CL)R}^{(1)} @ I_{RMS}$		$I_R @ V_R^{(2)}$
	V			$\Omega$		mA	%K		$\mu A$	V	V	A	$\mu A$	V
	min	typ	max	typ	max		min	max	max		max		max	
BZT03C6V2	5.8	6.2	6.6	1	2	100	0	0.07	1500	4.7	9.3	34.0	3000	5.1
BZT03C6V8	6.4	6.8	7.2	1	2	100	0	0.07	1000	5.1	10.2	31.0	2000	5.6
BZT03C7V5	7	7.5	7.9	1	2	100	0	0.07	750	5.6	11.3	26.5	1500	6.2
BZT03C8V2	7.7	8.2	8.7	1	2	100	0.03	0.08	600	6.2	12.3	24.4	1200	6.8
BZT03C9V1	8.5	9.1	9.6	2	4	50	0.03	0.08	20	6.8	13.3	22.7	50	7.5
BZT03C10	9.4	10	10.6	2	4	50	0.05	0.09	10	7.5	14.8	20.3	20	8.2
BZT03C11	10.4	11	11.6	4	7	50	0.05	0.1	4	8.2	15.7	19.1	5	9.1
BZT03C12	11.4	12	12.7	4	7	50	0.05	0.1	3	9.1	17.0	17.7	5	10
BZT03C13	12.4	13	14.1	5	10	50	0.05	0.1	2	10	18.9	15.9	5	11
BZT03C15	13.8	15	15.6	5	10	50	0.05	0.1	1	11	20.9	14.4	5	12
BZT03C16	15.3	16	17.1	6	15	25	0.06	0.11	1	12	22.9	13.1	5	13
BZT03C18	16.8	18	19.1	6	15	25	0.06	0.11	1	13	25.6	11.7	5	15
BZT03C20	18.8	20	21.2	6	15	25	0.06	0.11	1	15	28.4	10.6	5	16
BZT03C22	20.8	22	23.3	6	15	25	0.06	0.11	1	16	31.0	9.7	5	18
BZT03C24	22.8	24	25.6	7	15	25	0.06	0.11	1	18	33.8	8.9	5	20
BZT03C27	25.1	27	28.9	7	15	25	0.06	0.11	1	20	38.1	7.9	5	22
BZT03C30	28	30	32	8	15	25	0.06	0.11	1	22	42.2	7.1	5	24
BZT03C33	31	33	35	8	15	25	0.06	0.11	1	24	46.2	6.5	5	27
BZT03C36	34	36	38	21	40	10	0.06	0.11	1	27	50.1	6.0	5	30
BZT03C39	37	39	41	21	40	10	0.06	0.11	1	30	54.1	5.5	5	33
BZT03C43	40	43	46	24	45	10	0.07	0.12	1	33	60.7	4.9	5	36
BZT03C47	44	47	50	24	45	10	0.07	0.12	1	36	65.5	4.6	5	39
BZT03C51	48	51	54	25	60	10	0.07	0.12	1	39	70.8	4.2	5	43
BZT03C56	52	56	60	25	60	10	0.07	0.12	1	43	78.6	3.8	5	47
BZT03C62	58	62	66	25	80	10	0.08	0.13	1	47	86.5	3.5	5	51
BZT03C68	64	68	72	25	80	10	0.08	0.13	1	51	94.4	3.2	5	56
BZT03C75	70	75	79	30	100	10	0.08	0.13	1	56	103.5	2.9	5	62
BZT03C82	77	82	87	30	100	10	0.08	0.13	1	62	114	2.6	5	68
BZT03C91	85	91	96	60	200	5	0.09	0.13	1	68	126	2.4	5	75
BZT03C100	94	100	106	60	200	5	0.09	0.13	1	75	139	2.2	5	82
BZT03C110	104	110	116	80	250	5	0.09	0.13	1	82	152	2.0	5	91
BZT03C120	114	120	127	80	250	5	0.09	0.13	1	91	167	1.8	5	100
BZT03C130	124	130	141	110	300	5	0.09	0.13	1	100	185	1.6	5	110
BZT03C150	138	150	156	130	300	5	0.09	0.13	1	110	204	1.5	5	120
BZT03C160	153	160	171	150	350	5	0.09	0.13	1	120	224	1.3	5	130
BZT03C180	168	180	191	180	400	5	0.09	0.13	1	130	249	1.2	5	150
BZT03C200	188	200	212	200	500	5	0.09	0.13	1	150	276	1.1	5	160
BZT03C220	208	220	233	350	750	2	0.09	0.13	1	160	305	1.0	5	180
BZT03C240	228	240	256	400	850	2	0.09	0.13	1	180	336	0.9	5	200
BZT03C270	251	270	289	450	1000	2	0.09	0.13	1	200	380	0.8	5	220

<sup>1)</sup> 10/1000 exp. falling pulse  $t_p = 1000 \mu s$  down to 50 %

<sup>2)</sup> Stand-off voltage = recommended supply voltage



## Electrical Characteristics

BZT03D...

Partnumber	Zener Voltage Range			Dynamic Resistance		Test Current	Temperature Coefficient of Zener Voltage		Reverse Leakage Current		Clamping		Stand-off	
	$V_Z @ I_{ZT}$			$r_{zj}$ and $TK_{VZ} @ I_Z$			$I_{ZT}$	$TC_{VZ} @ I_{ZT}$		$I_R @ V_R$		$V_{(CL)R}^{(1)} @ I_{RMS}$		$I_R @ V_R^{(2)}$
	V			$\Omega$		mA	%K		$\mu A$	V	V	A	$\mu A$	V
	min	typ	max	typ	max		min	max	max		max		max	
BZT03D6V2	5.6	6.2	6.8	1	2	100	0	0.07	1500	4.4	9.5	34.0	3000	4.8
BZT03D6V8	6.1	6.8	7.5	1	2	100	0	0.07	1000	4.8	10.5	31.0	2000	5.3
BZT03D7V5	6.75	7.5	8.25	1	2	100	0	0.07	750	5.3	11.6	26.5	1500	5.9
BZT03D8V2	7.4	8.2	9	1	2	100	0.03	0.08	600	5.9	12.6	24.4	1200	6.5
BZT03D9V1	8.2	9.1	10	2	4	50	0.03	0.08	20	6.5	13.7	22.7	50	7.1
BZT03D10	9	10	11	2	4	50	0.05	0.09	10	7.1	15.2	20.3	20	7.9
BZT03D11	9.9	11	12.1	4	7	50	0.05	0.1	4	7.9	16.2	19.1	5	8.6
BZT03D12	10.8	12	13.2	4	7	50	0.05	0.1	3	8.6	17.5	17.7	5	9.3
BZT03D13	11.7	13	14.3	5	10	50	0.05	0.1	2	9.3	19.1	15.9	5	10.6
BZT03D15	13.5	15	16.5	5	10	50	0.05	0.1	1	10.6	21.8	14.4	5	11.6
BZT03D16	14.4	16	17.6	6	15	25	0.06	0.11	1	11.6	23.4	13.1	5	12.6
BZT03D18	16.2	18	19.8	6	15	25	0.06	0.11	1	12.6	26.3	11.7	5	14.4
BZT03D20	18	20	22	6	15	25	0.06	0.11	1	14.4	29.2	10.6	5	15.8
BZT03D22	29.8	22	24.2	6	15	25	0.06	0.11	1	15.8	31.9	9.7	5	17.2
BZT03D24	21.6	24	26.4	7	15	25	0.06	0.11	1	17.2	34.6	8.9	5	19.4
BZT03D27	24.3	27	29.7	7	15	25	0.06	0.11	1	19.4	39	7.9	5	21.5
BZT03D30	27	30	33	8	15	25	0.06	0.11	1	21.5	43.5	7.1	5	23.5
BZT03D33	29.7	33	36.3	8	15	25	0.06	0.11	1	23.5	47.5	6.5	5	25.8
BZT03D36	32.4	36	39.6	21	40	10	0.06	0.11	1	25.8	51.5	6.0	5	28
BZT03D39	35.1	39	42.9	21	40	10	0.06	0.11	1	28	56	5.5	5	31
BZT03D43	38.7	43	47.3	24	45	10	0.07	0.12	1	31	62	4.9	5	33.5
BZT03D47	42.3	47	51.7	24	45	10	0.07	0.12	1	33.5	67.5	4.6	5	36.5
BZT03D51	45.9	51	56.1	25	60	10	0.07	0.12	1	36.5	73	4.2	5	40
BZT03D56	50.4	56	61.6	25	60	10	0.07	0.12	1	40	81	3.8	5	44.5
BZT03D62	55.8	62	68.2	25	80	10	0.08	0.13	1	44.5	89	3.5	5	49
BZT03D68	61.2	68	74.8	25	80	10	0.08	0.13	1	49	97	3.2	5	54
BZT03D75	67.5	75	82.5	30	100	10	0.08	0.13	1	54	107	2.9	5	59
BZT03D82	73.8	82	90.2	30	100	10	0.08	0.13	1	59	117	2.6	5	65
BZT03D91	81.9	91	100	60	200	5	0.09	0.13	1	65	130	2.4	5	71
BZT03D100	90	100	110	60	200	5	0.09	0.13	1	71	143	2.2	5	79
BZT03D110	99	110	121	80	250	5	0.09	0.13	1	79	157	2.0	5	86
BZT03D120	108	120	132	80	250	5	0.09	0.13	1	86	172	1.8	5	93
BZT03D130	117	130	143	110	300	5	0.09	0.13	1	93	187	1.6	5	106
BZT03D150	135	150	165	130	300	5	0.09	0.13	1	106	213	1.5	5	116
BZT03D160	144	160	176	150	350	5	0.09	0.13	1	116	229	1.3	5	126
BZT03D180	162	180	198	180	400	5	0.09	0.13	1	126	256	1.2	5	144
BZT03D200	180	200	220	200	500	5	0.09	0.13	1	144	284	1.1	5	158
BZT03D220	198	220	242	350	750	2	0.09	0.13	1	158	314	1.0	5	172
BZT03D240	216	240	264	400	850	2	0.09	0.13	1	172	364	0.9	5	194
BZT03D270	243	270	297	450	1000	2	0.09	0.13	1	194	388	0.8	5	215

<sup>1)</sup> 10/1000 exp. falling pulse tp = 1000  $\mu s$  down to 50 %

<sup>2)</sup> Stand-off voltage = recommended supply voltage

## Typical Characteristics ( $T_{amb} = 25\text{ }^{\circ}\text{C}$ unless otherwise specified)

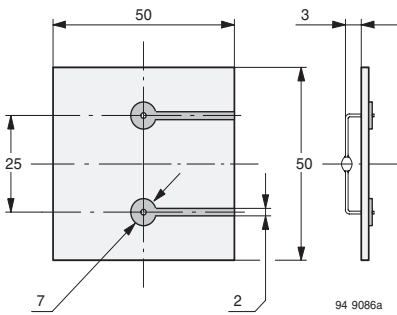

Figure 1. Epoxy Glass Hard Tissue, Board Thickness 1.5 mm,  
 $R_{thJA} \leq 100\text{ K/W}$

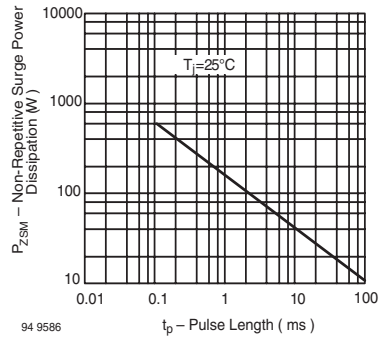

Figure 4. Non Repetitive Surge Power Dissipation vs. Pulse Length

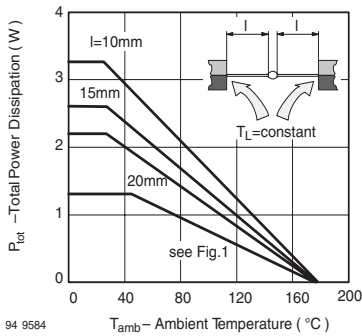

Figure 2. Total Power Dissipation vs. Ambient Temperature

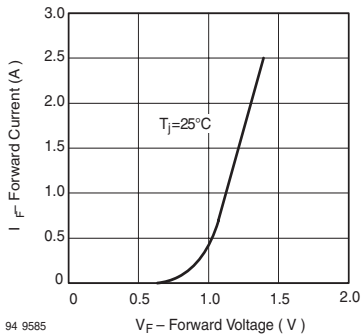

Figure 3. Forward Current vs. Forward Voltage

## SOD-57 Package Dimension see Package Section

## Small Signal Zener Diodes

### Features

- Silicon Planar Power Zener Diodes
- These diodes are also available in other case styles and other configurations including: the SOT-23 case with type designation BZX84 series, the dual zener diode common anode configuration in the SOT-23 case with type designation AZ23 series and the dual zener diode common cathode configuration in the SOT-23 case with type designation DZ23 series.
- The Zener voltages are graded according to the international E 24 standard.

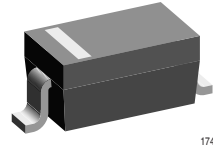

### Mechanical Data

**Case:** SOD-123 Plastic case

**Weight:** approx. 9.3 mg

**Packaging Codes/Options:**

GS18 / 10 k per 13 " reel (8 mm tape), 10 k/box

GS08 / 3 k per 7 " reel (8 mm tape), 15 k/box

### Absolute Maximum Ratings

$T_{amb} = 25\text{ }^{\circ}\text{C}$ , unless otherwise specified

Parameter	Test condition	Symbol	Value	Unit
Zener current see table "Characteristics "				
Power dissipation		$P_{tot}$	410 <sup>1)</sup>	mW

<sup>1)</sup> Diode on ceramic substrate 0.7 mm; 2.5 mm<sup>2</sup> area

### Thermal Characteristics

$T_{amb} = 25\text{ }^{\circ}\text{C}$ , unless otherwise specified

Parameter	Test condition	Symbol	Value	Unit
Thermal resistance junction to ambient air		$R_{thJA}$	300 <sup>1)</sup>	$^{\circ}\text{C/W}$
Junction temperature		$T_J$	150	$^{\circ}\text{C}$
Storage temperature range		$T_S$	- 65 to + 150	$^{\circ}\text{C}$

<sup>1)</sup> Valid provided that electrodes are kept at ambient temperature

### Electrical Characteristics

Partnumber	Marking Code	Zener Voltage Range <sup>1)</sup>		Dynamic Resistance		Test Current	Temp. Coefficient	Reverse Voltage	Admissible Zener Current <sup>4)</sup>	
		$V_Z @ I_{ZT1}$	$V_Z @ I_{ZT1}$	$r_{zj} @ I_{ZT1}$	$r_{zj} @ I_{ZT2}$				$I_{ZT1}$	$I_Z @ T_{amb} = 45^\circ C,$
		V		$\Omega$		mA	$\alpha_{VZ}$ ( $10^{-4}/^\circ C$ )	V	mA	
		min	max							
BZT52C2V4	W1	2.2	2.6	85	600	5	- 9 to - 4	-	-	-
BZT52C2V7	W2	2.5	2.9	75 (< 83)	< 500	5	- 9 to - 4	-	113	134
BZT52C3	W3	2.8	3.2	80 (< 95)	< 500	5	- 9 to - 3	-	98	118
BZT52C3V3	W4	3.1	3.5	80 (< 95)	< 500	5	- 8 to - 3	-	92	109
BZT52C3V6	W5	3.4	3.8	80 (< 95)	< 500	5	- 8 to - 3	-	85	100
BZT52C3V9	W6	3.7	4.1	80 (< 95)	< 500	5	- 7 to - 3	-	77	92
BZT52C4V3	W7	4	4.6	80 (< 95)	< 500	5	- 6 to - 1	-	71	84
BZT52C4V7	W8	4.4	5	70 (< 78)	< 500	5	- 5 to +2	-	64	76
BZT52C5V1	W9	4.8	5.4	30 (< 60)	< 480	5	- 3 to +4	> 0.8	56	67
BZT52C5V6	WA	5.2	6	10 (< 40)	< 400	5	- 2 to +6	> 1	50	59
BZT52C6V2	WB	5.8	6.6	4.8 (< 10)	< 200	5	- 1 to +7	> 2	45	54
BZT52C6V8	WC	6.4	7.2	4.5 (< 8)	< 150	5	+2 to +7	> 3	41	49
BZT52C7V5	WD	7	7.9	4 (< 7)	< 50	5	+3 to +7	> 5	37	44
BZT52C8V2	WE	7.7	8.7	4.5 (< 7)	< 50	5	+4 to +7	> 6	34	40
BZT52C9V1	WF	8.5	9.6	4.8 (< 10)	< 50	5	+5 to +8	> 7	30	36
BZT52C10	WG	9.4	10.6	5.2 (< 15)	< 70	5	+5 to +8	> 7.5	28	33
BZT52C11	WH	10.4	11.6	6 (< 20)	< 70	5	+5 to +9	> 8.5	25	30
BZT52C12	WI	11.4	12.7	7 (< 20)	< 90	5	+6 to +9	> 9	23	28
BZT52C13	WK	12.4	14.1	9 (< 25)	< 110	5	+7 to +9	> 10	21	25
BZT52C15	WL	13.8	15.6	11 (< 30)	< 110	5	+7 to +9	> 11	19	23
BZT52C16	WM	15.3	17.1	13 (< 40)	< 170	5	+8 to +9.5	> 12	17	20
BZT52C18	WN	16.8	19.1	18 (< 50)	< 170	5	+8 to +9.5	> 14	15	18
BZT52C20	WO	18.8	21.2	20 (< 50)	< 220	5	+8 to +10	> 15	14	17
BZT52C22	WP	20.8	23.3	25 (< 55)	< 220	5	+8 to +10	> 17	13	16
BZT52C24	WR	22.8	25.6	28 (< 80)	< 220	5	+8 to +10	> 18	11	13
BZT52C27	WS	25.1	28.9	30 (< 80)	< 250	5	+8 to +10	> 20	10	12
BZT52C30	WT	28	32	35 (< 80)	< 250	5	+8 to +10	> 22.5	9	10
BZT52C33	WU	31	35	40 (< 80)	< 250	5	+8 to +10	> 25	8	9
BZT52C36	WW	34	38	40 (< 90)	< 250	5	+8 to +10	> 27	8	9
BZT52C39	WX	37	41	50 (< 90)	< 300	5	+10 to +12	> 29	7	8
BZT52C43	WY	40	46	60 (< 100)	< 700	5	+10 to +12	> 32	6	7
BZT52C47	WZ	44	50	70 (< 100)	< 750	5	+10 to +12	> 35	5	6
BZT52C51	X1	48	54	70 (< 100)	< 750	5	+10 to +12	> 38	5	6
BZT52C56	X2	52	60	< 135 <sup>(2)</sup>	< 1000 <sup>(3)</sup>	2.5	typ. +10 <sup>(2)</sup>	-	-	-
BZT52C62	X3	58	66	< 150 <sup>(2)</sup>	< 1000 <sup>(3)</sup>	2.5	typ. +10 <sup>(2)</sup>	-	-	-
BZT52C68	X4	64	72	< 200 <sup>(2)</sup>	< 1000 <sup>(3)</sup>	2.5	typ. +10 <sup>(2)</sup>	-	-	-
BZT52C75	X5	70	79	< 250 <sup>(2)</sup>	< 1500 <sup>(3)</sup>	2.5	typ. +10 <sup>(2)</sup>	-	-	-

$I_{ZT1} = 5 \text{ mA}$ ,  $I_{ZT2} = 1 \text{ mA}$

(1) Measured with pulses  $T_p = 5 \text{ ms}$

(2) =  $I_{ZT1} = 2.5 \text{ mA}$

(3) =  $I_{ZT2} = 0.5 \text{ mA}$

(4) Valid provided that electrodes are kept at ambient temperature.

### Electrical Characteristics

Partnumber	Marking Code	Zener Voltage Range <sup>1)</sup>		Dynamic Resistance		Test Current	Temp. Coefficient @ I <sub>ZT1</sub>	Reverse Voltage V <sub>R</sub> @ I <sub>R</sub> = 100 nA,	Admissible Zener Current <sup>4)</sup>		
		V <sub>Z</sub> @ I <sub>ZT1</sub>		r <sub>zj</sub> @ I <sub>ZT1</sub>	r <sub>zj</sub> @ I <sub>ZT2</sub>				I <sub>ZT1</sub>	I <sub>Z</sub> @ T <sub>amb</sub> = 45 °C,	I <sub>Z</sub> @ T <sub>amb</sub> = 25 °C,
		V		Ω					mA	mA	
		min	max				α <sub>VZ</sub> (10 <sup>-4</sup> /°C)	V			
BZT52B2V4	W1	2.35	2.45	85	600	5	- 9 to - 4	-	-	-	
BZT52B2V7	W2	2.65	2.75	75 (< 83)	< 500	5	- 9 to - 4	-	113	134	
BZT52B3	W3	2.94	3.06	80 (< 95)	< 500	5	- 9 to - 3	-	98	118	
BZT52B3V3	W4	3.23	3.37	80 (< 95)	< 500	5	- 8 to - 3	-	92	109W5	
BZT52B3V6	W5	3.53	3.67	80 (< 95)	< 500	5	- 8 to - 3	-	85	100	
BZT52B3V9	W6	3.82	3.98	80 (< 95)	< 500	5	- 7 to - 3	-	77	92	
BZT52B4V3	W7	4.21	4.39	80 (< 95)	< 500	5	- 6 to - 1	-	71	84	
BZT52B4V7	W8	4.61	4.79	70 (< 78)	< 500	5	- 5 to + 2	-	64	76	
BZT52B5V1	W9	5	5.2	30 (< 60)	< 480	5	- 3 to + 4	> 0.8	56	67	
BZT52B5V6	WA	5.49	5.71	10 (< 40)	< 400	5	- 2 to + 6	> 1	50	59	
BZT52B6V2	WB	6.08	6.32	4.8 (< 10)	< 200	5	- 1 to + 7	> 2	45	54	
BZT52B6V8	WC	6.66	6.94	4.5 (< 8)	< 150	5	+ 2 to + 7	> 3	41	49	
BZT52B7V5	WD	7.35	7.65	4 (< 7)	< 50	5	+ 3 to + 7	> 5	37	44	
BZT52B8V2	WE	8.04	8.36	4.5 (< 7)	< 50	5	+ 4 to + 7	> 6	34	40	
BZT52B9V1	WF	8.92	9.28	4.8 (< 10)	< 50	5	+ 5 to + 8	> 7	30	36	
BZT52B10	WG	9.8	10.2	5.2 (< 15)	< 70	5	+ 5 to + 8	> 7.5	28	33	
BZT52B11	WH	10.8	11.2	6 (< 20)	< 70	5	+ 5 to + 9	> 8.5	25	30	
BZT52B12	WI	11.8	12.2	7 (< 20)	< 90	5	+ 6 to + 9	> 9	23	28	
BZT52B13	WK	12.7	13.3	9 (< 25)	< 110	5	+ 7 to + 9	> 10	21	25	
BZT52B15	WL	14.7	15.3	11 (< 30)	< 110	5	+ 7 to + 9	> 11	19	23	
BZT52B16	WM	15.7	16.3	13 (< 40)	< 170	5	+ 8 to + 9.5	> 12	17	20	
BZT52B18	WN	17.6	18.4	18 (< 50)	< 170	5	+ 8 to + 9.5	> 14	15	18	
BZT52B20	WO	19.6	20.4	20 (< 50)	< 220	5	+ 8 to + 10	> 15	14	17	
BZT52B22	WP	21.6	22.4	25 (< 55)	< 220	5	+ 8 to + 10	> 17	13	16	
BZT52B24	WR	23.5	24.5	28 (< 80)	< 220	5	+ 8 to + 10	> 18	11	13	
BZT52B27	WS	26.5	27.5	30 (< 80)	< 250	5	+ 8 to + 10	> 20	10	12	
BZT52B30	WT	29.4	30.6	35 (< 80)	< 250	5	+ 8 to + 10	> 22.5	9	10	
BZT52B33	WU	32.3	33.7	40 (< 80)	< 250	5	+ 8 to + 10	> 25	8	9	
BZT52B36	WW	35.3	36.7	40 (< 90)	< 250	5	+ 8 to + 10	> 27	8	9	
BZT52B39	WX	38.2	39.8	50 (< 90)	< 300	5	+ 10 to + 12	> 29	7	8	
BZT52B43	WY	42.1	43.9	60 (< 100)	< 700	5	+ 10 to + 12	> 32	6	7	
BZT52B47	WZ	46.1	47.9	70 (< 100)	< 750	5	+ 10 to + 12	> 35	5	6	
BZT52B51	X1	50	52	70 (< 100)	< 750	5	+ 10 to + 12	> 38	5	6	
BZT52B56	X2	54.9	57.1	< 135 <sup>(2)</sup>	< 1000 <sup>(3)</sup>	2.5	typ. + 10 <sup>(2)</sup>	-	-	-	
BZT52B62	X3	60.8	63.2	< 150 <sup>(2)</sup>	< 1000 <sup>(3)</sup>	2.5	typ. + 10 <sup>(2)</sup>	-	-	-	
BZT52B68	X4	66.6	69.4	< 200 <sup>(2)</sup>	< 1000 <sup>(3)</sup>	2.5	typ. + 10 <sup>(2)</sup>	-	-	-	
BZT52B75	X5	73.5	76.5	< 250 <sup>(2)</sup>	< 1500 <sup>(3)</sup>	2.5	typ. + 10 <sup>(2)</sup>	-	-	-	

I<sub>ZT1</sub> = 5 mA, I<sub>ZT2</sub> = 1 mA

<sup>1)</sup> Measured with pulses T<sub>p</sub> = 5 ms

<sup>2)</sup> = I<sub>ZT1</sub> = 2.5 mA

<sup>3)</sup> = I<sub>ZT2</sub> = 0.5 mA

<sup>4)</sup> Valid provided that electrodes are kept at ambient temperature.

## Typical Characteristics ( $T_{amb} = 25\text{ }^{\circ}\text{C}$ unless otherwise specified)

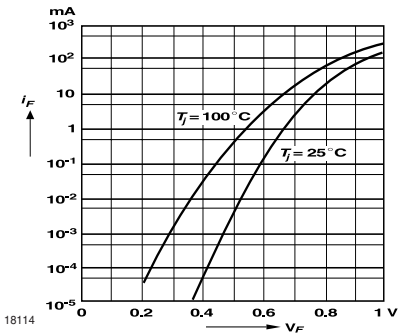

Figure 1. Forward characteristics

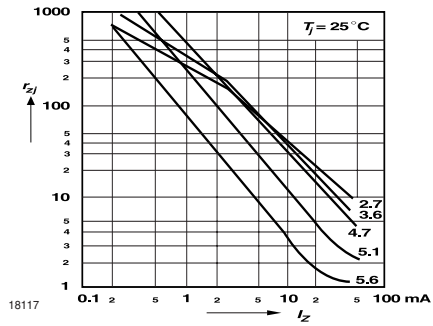

Figure 4. Dynamic Resistance vs. Zener Current

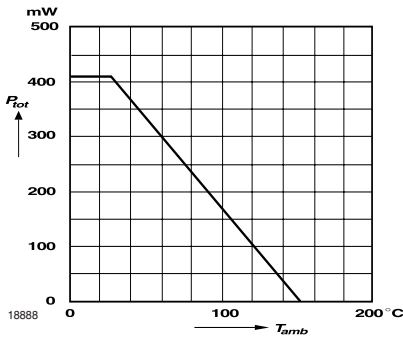

Figure 2. Admissible Power Dissipation vs. Ambient Temperature

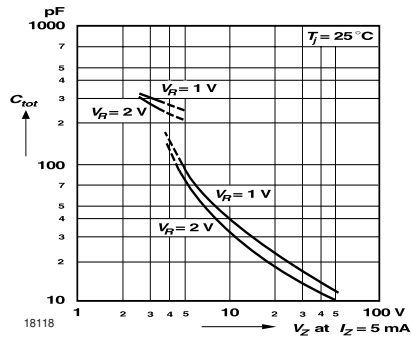

Figure 5. Capacitance vs. Zener Voltage

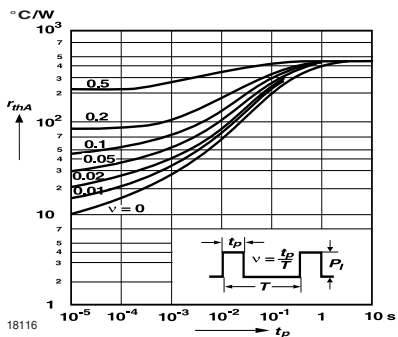

Figure 3. Pulse Thermal Resistance vs. Pulse Duration

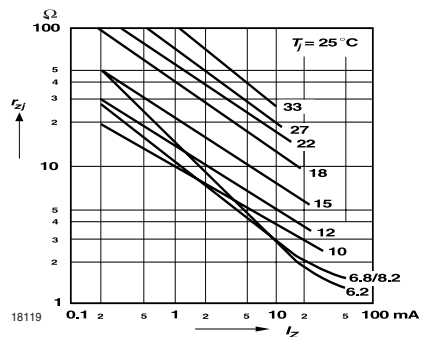

Figure 6. Dynamic Resistance vs. Zener Current

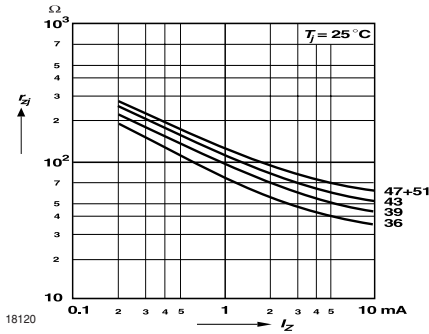

Figure 7. Dynamic Resistance vs. Zener Current

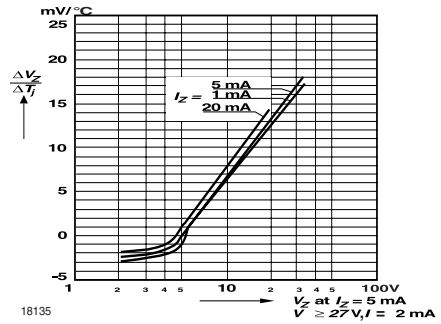

Figure 10. Temperature Dependence of Zener Voltage vs. Zener Voltage

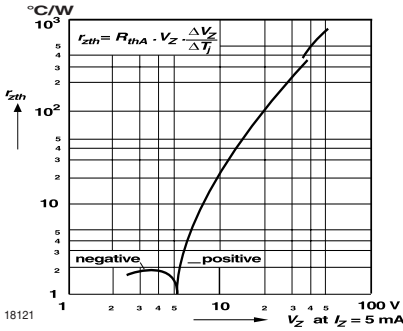

Figure 8. Thermal Differential Resistance vs. Zener Voltage

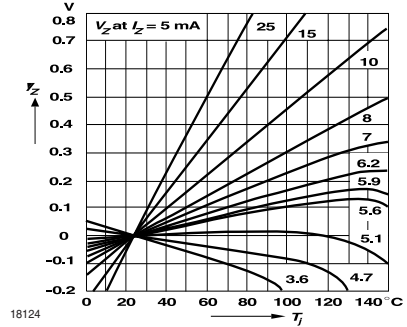

Figure 11. Change of Zener Voltage vs. Junction Temperature

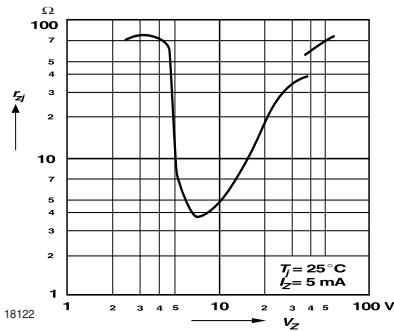

Figure 9. Dynamic Resistance vs. Zener Voltage

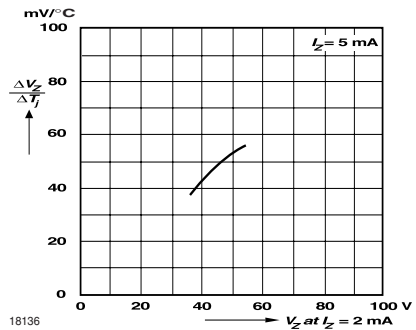

Figure 12. Temperature Dependence of Zener Voltage vs. Zener Voltage



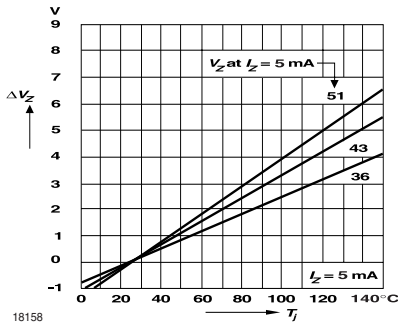

Figure 13. Change of Zener Voltage vs. Junction Temperature

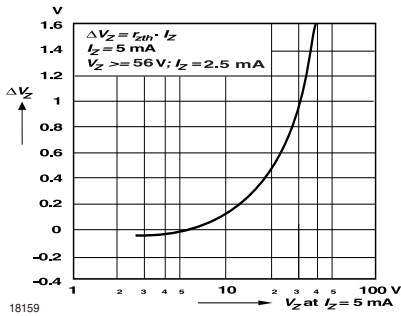

Figure 14. Change of Zener voltage from turn-on up to the point of thermal equilibrium vs. Zener voltage

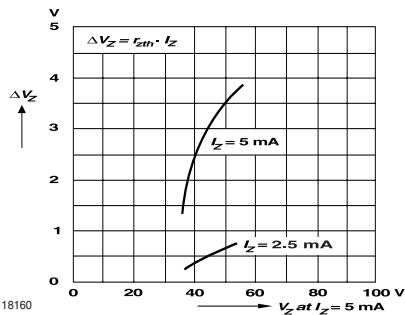

Figure 15. Change of Zener voltage from turn-on up to the point of thermal equilibrium vs. Zener voltage

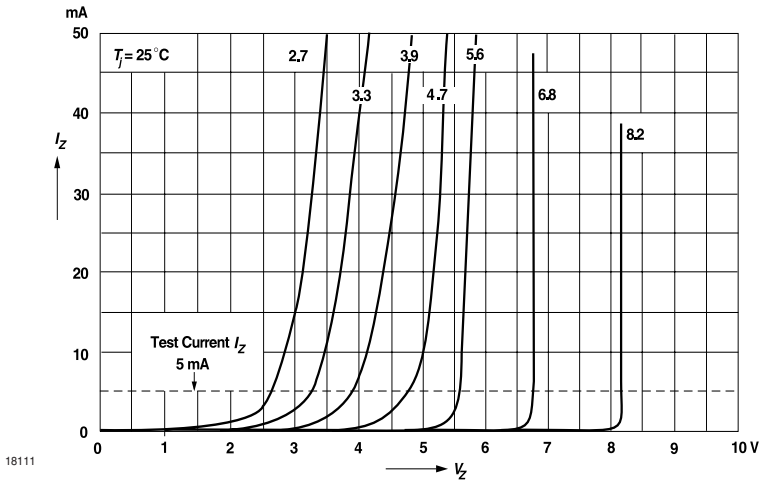

Figure 16. Breakdown Characteristics

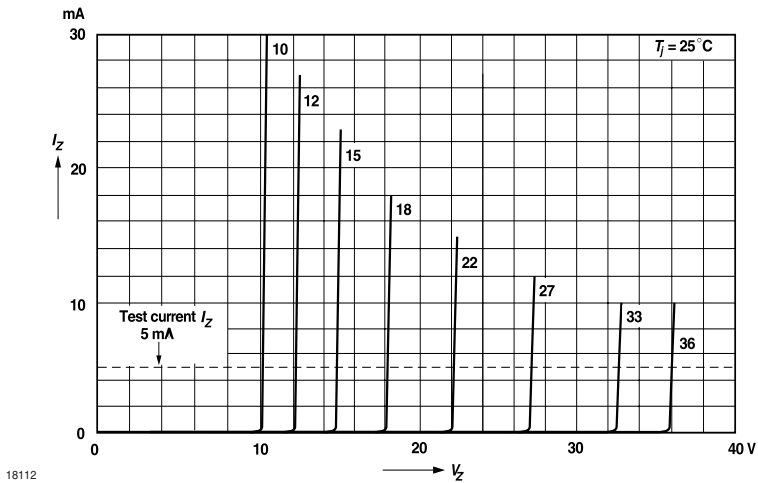
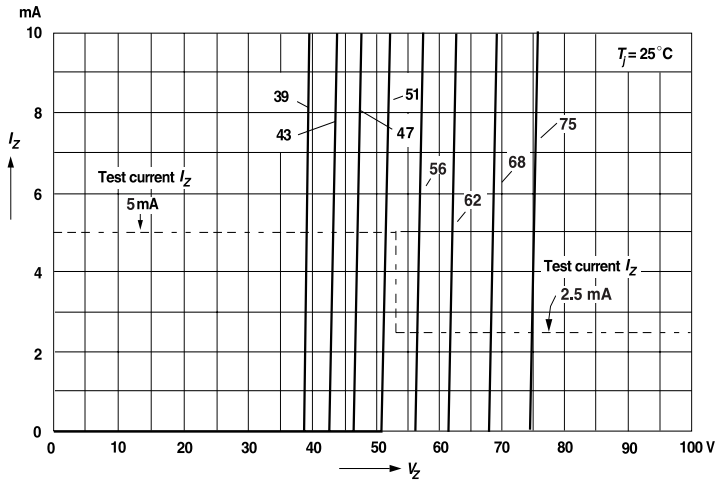

Figure 17. Breakdown Characteristics



18157

Figure 18. Breakdown Characteristics

**SOD-123 Package Dimension**  
see Package Section

## Small Signal Zener Diodes

### Features

- Very sharp reverse characteristic
- Low reverse current level
- Available with tighter tolerances
- Very high stability
- Low noise

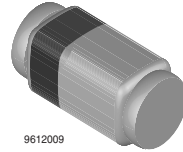

### Applications

Voltage stabilization

### Mechanical Data

**Case:** QuadMELF Glass case (SOD-80)

**Weight:** approx. 34 mg

**Packaging Codes/Options:**

GS08 / 2.5 k per 7" reel 12.5 k/box

GS18 / 10 k per 13" reel 10 k/box

### Absolute Maximum Ratings

$T_{amb} = 25\text{ }^{\circ}\text{C}$ , unless otherwise specified

Parameter	Test condition	Symbol	Value	Unit
Power dissipation	$R_{thJA} \leq 300\text{ K/W}$	$P_V$	500	mW
Z-current		$I_Z$	$P_V/V_Z$	mA
Junction temperature		$T_j$	175	$^{\circ}\text{C}$
Storage temperature range		$T_{stg}$	- 65 to + 175	$^{\circ}\text{C}$

### Thermal Characteristics

$T_{amb} = 25\text{ }^{\circ}\text{C}$ , unless otherwise specified

Parameter	Test condition	Symbol	Value	Unit
Junction ambient	on PC board 50 mm x 50 mm x 1.6 mm	$R_{thJA}$	500	K/W

### Electrical Characteristics

$T_{amb} = 25\text{ }^{\circ}\text{C}$ , unless otherwise specified

Parameter	Test condition	Symbol	Min	Typ.	Max	Unit
Forward voltage	$I_F = 200\text{ mA}$	$V_F$			1.5	V

### Electrical Characteristics

BZT55C..

Partnumber	Zener Voltage <sup>1)</sup>		Dynamic Resistance		Test Current	Temperature Coefficient		Test Current	Reverse Leakage Current		
	$V_Z @ I_{ZT}$		$r_{zj} @ I_{ZT}$		$I_{ZT}$	$TK_{VZ}$		$I_{ZK}$	$I_R @ T_{amb} = 25^{\circ}C$	$I_R @ T_{amb} = 150^{\circ}C$	$@ V_R$
	min	max	$\Omega$	$\Omega$	mA	min	max	mA	$\mu A$	$\mu A$	V
BZT55C2V4	2.28	2.56	< 85	< 600	5	-0.09	-0.06	1	< 50	< 100	1
BZT55C2V7	2.5	2.9	< 85	< 600	5	-0.09	-0.06	1	< 10	< 50	1
BZT55C3V0	2.8	3.2	< 90	< 600	5	-0.08	-0.05	1	< 4	< 40	1
BZT55C3V3	3.1	3.5	< 90	< 600	5	-0.08	-0.05	1	< 2	< 40	1
BZT55C3V6	3.4	3.8	< 90	< 600	5	-0.08	-0.05	1	< 2	< 40	1
BZT55C3V9	3.7	4.1	< 90	< 600	5	-0.08	-0.05	1	< 2	< 40	1
BZT55C4V3	4	4.6	< 90	< 600	5	-0.06	-0.03	1	< 1	< 20	1
BZT55C4V7	4.4	5	< 80	< 600	5	-0.05	0.02	1	< 0.5	< 10	1
BZT55C5V1	4.8	5.4	< 60	< 550	5	-0.02	0.02	1	< 0.1	< 2	1
BZT55C5V6	5.2	6	< 40	< 450	5	-0.05	+0.05	1	< 0.1	< 2	1
BZT55C6V2	5.8	6.6	< 10	< 200	5	0.03	0.06	1	< 0.1	< 2	2
BZT55C6V8	6.4	7.2	< 8	< 150	5	0.03	0.07	1	< 0.1	< 2	3
BZT55C7V5	7	7.9	< 7	< 50	5	0.03	0.07	1	< 0.1	< 2	5
BZT55C8V2	7.7	8.7	< 7	< 50	5	0.03	0.08	1	< 0.1	< 2	6.2
BZT55C9V1 *	8.5	9.6	< 10	< 50	5	0.03	0.09	1	< 0.1	< 2	6.8
BZT55C10 *	9.4	10.6	< 15	< 70	5	0.03	0.1	1	< 0.1	< 2	7.5
BZT55C11 *	10.4	11.6	< 20	< 70	5	0.03	0.11	1	< 0.1	< 2	8.2
BZT55C12 *	11.4	12.7	< 20	< 90	5	0.03	0.11	1	< 0.1	< 2	9.1
BZT55C13 *	12.4	14.1	< 26	< 110	5	0.03	0.11	1	< 0.1	< 2	10
BZT55C15 *	13.8	15.6	< 30	< 110	5	0.03	0.11	1	< 0.1	< 2	11
BZT55C16 *	15.3	17.1	< 40	< 170	5	0.03	0.11	1	< 0.1	< 2	12
BZT55C18 *	16.8	19.1	< 50	< 170	5	0.03	0.11	1	< 0.1	< 2	13
BZT55C20 *	18.8	21.2	< 55	< 220	5	0.03	0.11	1	< 0.1	< 2	15
BZT55C22 *	20.8	23.3	< 55	< 220	5	0.04	0.12	1	< 0.1	< 2	16
BZT55C24 *	22.8	25.6	< 80	< 220	5	0.04	0.12	1	< 0.1	< 2	18
BZT55C27 *	25.1	28.9	< 80	< 220	5	0.04	0.12	1	< 0.1	< 2	20
BZT55C30 *	28	32	< 80	< 220	5	0.04	0.12	1	< 0.1	< 2	22
BZT55C33 *	31	35	< 80	< 220	5	0.04	0.12	1	< 0.1	< 2	24
BZT55C36 *	34	38	< 80	< 220	5	0.04	0.12	1	< 0.1	< 2	27
BZT55C39 *	37	41	< 90	< 500	2.5	0.04	0.12	0.5	< 0.1	< 5	30
BZT55C43 *	40	46	< 90	< 600	2.5	0.04	0.12	0.5	< 0.1	< 5	33
BZT55C47 *	44	50	< 110	< 700	2.5	0.04	0.12	0.5	< 0.1	< 5	36
BZT55C51 *	48	54	< 125	< 700	2.5	0.04	0.12	0.5	< 0.1	< 10	39
BZT55C56 *	52	60	< 135	< 1000	2.5	0.04	0.12	0.5	< 0.1	< 10	43
BZT55C62 *	58	66	< 150	< 1000	2.5	0.04	0.12	0.5	< 0.1	< 10	47
BZT55C68 *	64	72	< 200	< 1000	2.5	0.04	0.12	0.5	< 0.1	< 10	51
BZT55C75 *	70	79	< 250	< 1500	2.5	0.04	0.12	0.5	< 0.1	< 10	56

<sup>1)</sup>  $t_p \leq 10$  ms,  $T/t_p > 1000$ .

<sup>2)</sup> Additional measurement of Voltage group 9V1 to 75 at 95 %  $V_{Zmin} \leq 35$  nA at  $T_j 25^{\circ}C$



## Electrical Characteristics

BZT55B..

Partnumber	Zener Voltage <sup>1)</sup>		Dynamic Resistance		Test Current	Temperature Coefficient of Zener Voltage		Test Current	Reverse Leakage Current		
	$V_Z @ I_{ZT}$		$r_{zj} @ I_{ZT}, f = 1 \text{ kHz}$			$I_{ZT}$	TK <sub>VZ</sub>		$I_{ZK}$	$I_R @ T_{amb} = 25^\circ\text{C}$	$I_R @ T_{amb} = 150^\circ\text{C}$
	V		Ω		mA	%/K		mA	μA	V	
	min	max				min	max				
BZT55B2V4	2.35	2.45	< 85	< 600	5	-0.09	-0.06	1	< 50	< 100	1
BZT55B2V7	2.64	2.76	< 85	< 600	5	-0.09	-0.06	1	< 10	< 50	1
BZT55B3V0	2.94	3.06	< 90	< 600	5	-0.08	-0.05	1	< 4	< 40	1
BZT55B3V3	3.24	3.36	< 90	< 600	5	-0.08	-0.05	1	< 2	< 40	1
BZT55B3V6	3.52	3.68	< 90	< 600	5	-0.08	-0.05	1	< 2	< 40	1
BZT55B3V9	3.82	3.98	< 90	< 600	5	-0.08	-0.05	1	< 2	< 40	1
BZT55B4V3	4.22	4.38	< 90	< 600	5	-0.06	-0.03	1	< 1	< 20	1
BZT55B4V7	4.6	4.8	< 80	< 600	5	-0.05	0.02	1	< 0.5	< 10	1
BZT55B5V1	5	5.2	< 60	< 550	5	-0.02	0.02	1	< 0.1	< 2	1
BZT55B5V6	5.48	5.72	< 40	< 450	5	-0.05	0.05	1	< 0.1	< 2	1
BZT55B6V2	6.08	6.32	< 10	< 200	5	0.03	0.06	1	< 0.1	< 2	2
BZT55B6V8	6.66	6.94	< 8	< 150	5	0.03	0.07	1	< 0.1	< 2	3
BZT55B7V5	7.35	7.65	< 7	< 50	5	0.03	0.07	1	< 0.1	< 2	5
BZT55B8V2	8.04	8.36	< 7	< 50	5	0.03	0.08	1	< 0.1	< 2	6.2
BZT55B9V1 *	8.92	9.28	< 10	< 50	5	0.03	0.09	1	< 0.1	< 2	6.8
BZT55B10 *	9.8	10.2	< 15	< 70	5	0.03	0.1	1	< 0.1	< 2	7.5
BZT55B11 *	10.78	11.22	< 20	< 70	5	0.03	0.11	1	< 0.1	< 2	8.2
BZT55B12 *	11.76	12.24	< 20	< 90	5	0.03	0.11	1	< 0.1	< 2	9.1
BZT55B13 *	12.74	13.26	< 26	< 110	5	0.03	0.11	1	< 0.1	< 2	10
BZT55B15 *	14.7	15.3	< 30	< 110	5	0.03	0.11	1	< 0.1	< 2	11
BZT55B16 *	15.7	16.3	< 40	< 170	5	0.03	0.11	1	< 0.1	< 2	12
BZT55B18 *	17.64	18.36	< 50	< 170	5	0.03	0.11	1	< 0.1	< 2	13
BZT55B20 *	19.6	20.4	< 55	< 220	5	0.03	0.11	1	< 0.1	< 2	15
BZT55B22 *	21.55	22.45	< 55	< 220	5	0.04	0.12	1	< 0.1	< 2	16
BZT55B24 *	23.5	24.5	< 80	< 220	5	0.04	0.12	1	< 0.1	< 2	18
BZT55B27 *	26.4	27.6	< 80	< 220	5	0.04	0.12	1	< 0.1	< 2	20
BZT55B30 *	29.4	30.6	< 80	< 220	5	0.04	0.12	1	< 0.1	< 2	22
BZT55B33 *	32.4	33.6	< 80	< 220	5	0.04	0.12	1	< 0.1	< 2	24
BZT55B36 *	35.3	36.7	< 80	< 220	5	0.04	0.12	1	< 0.1	< 2	27
BZT55B39 *	38.2	39.8	< 90	< 500	2.5	0.04	0.12	1	< 0.1	< 5	30
BZT55B43 *	42.1	43.9	< 90	< 600	2.5	0.04	0.12	0.5	< 0.1	< 5	33
BZT55B47 *	46.1	47.9	< 110	< 700	2.5	0.04	0.12	0.5	< 0.1	< 5	36
BZT55B51 *	50	52	< 125	< 700	2.5	0.04	0.12	0.5	< 0.1	< 10	39
BZT55B56 *	54.9	57.1	< 135	< 1000	2.5	0.04	0.12	0.5	< 0.1	< 10	43
BZT55B62 *	60.8	63.2	< 150	< 1000	2.5	0.04	0.12	0.5	< 0.1	< 10	47
BZT55B68 *	66.6	69.4	< 200	< 1000	2.5	0.04	0.12	0.5	< 0.1	< 10	51
BZT55B75 *	73.5	76.5	< 250	< 1500	2.5	0.04	0.12	0.5	< 0.1	< 10	56

<sup>1)</sup>  $t_p \leq 10 \text{ ms}, T/t_p > 1000.$

<sup>2)</sup> Additional measurement of Voltage group 9V1 to 75 at 95 %  $V_{zmin} \leq 35 \text{ nA}$  at  $T_j 25^\circ\text{C}$

### Typical Characteristics ( $T_{amb} = 25\text{ }^{\circ}\text{C}$ unless otherwise specified)

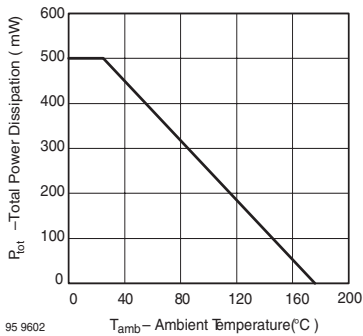

Figure 1. Total Power Dissipation vs. Ambient Temperature

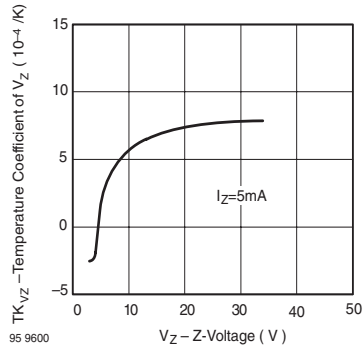

Figure 4. Temperature Coefficient of  $V_Z$  vs. Z-Voltage

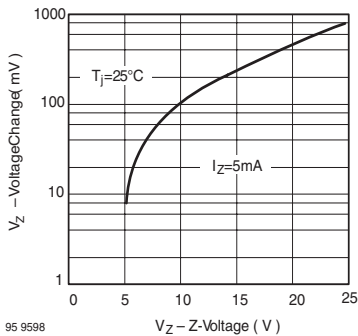

Figure 2. Typical Change of Working Voltage under Operating Conditions at  $T_{amb}=25\text{ }^{\circ}\text{C}$

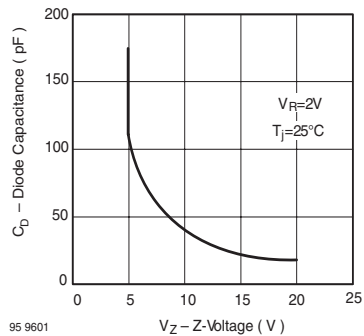

Figure 5. Diode Capacitance vs. Z-Voltage

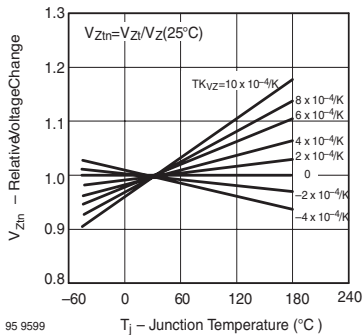

Figure 3. Typical Change of Working Voltage vs. Junction Temperature

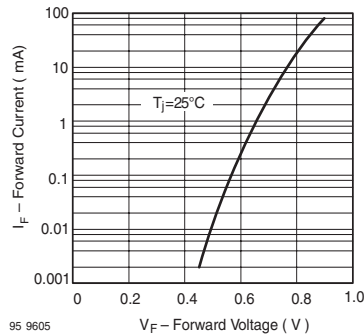

Figure 6. Forward Current vs. Forward Voltage

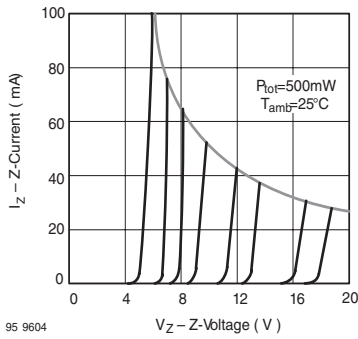

Figure 7. Z-Current vs. Z-Voltage

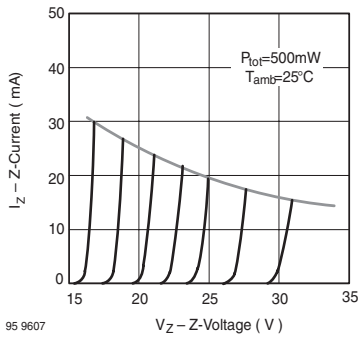

Figure 8. Z-Current vs. Z-Voltage

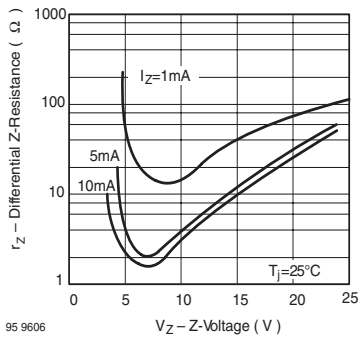

Figure 9. Differential Z-Resistance vs. Z-Voltage



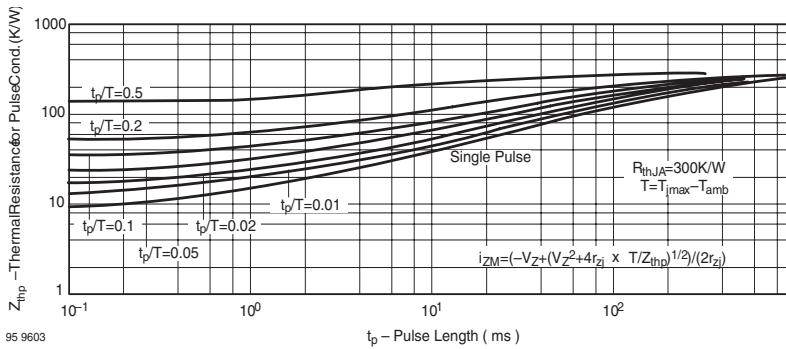

Figure 10. Thermal Response

**QuadromELF SOD-80  
Package Dimension  
see Package Section**

## Zener Diodes with Surge Current Specification

### Features

- Glass passivated junction
- Hermetically sealed package
- Clamping time in picoseconds

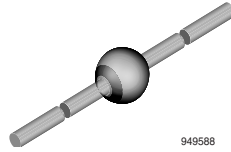

### Applications

Voltage regulators and transient suppression circuits

### Mechanical Data

**Case:** SOD-64 Sintered glass case

**Weight:** approx. 858 mg

**Packaging Codes/Options:**

TAP / 2.5 k Ammopack (52 mm tape), 12.5 k/box

TR / 2.5 k 10 " reel

### Absolute Maximum Ratings

$T_{amb} = 25\text{ }^{\circ}\text{C}$ , unless otherwise specified

Parameter	Test condition	Symbol	Value	Unit
Power dissipation	$I = 10\text{ mm}$ , $T_L = 25\text{ }^{\circ}\text{C}$	$P_{diss}$	6.0	W
	$T_{amb} = 45\text{ }^{\circ}\text{C}$	$P_{diss}$	1.85	W
Repetitive peak reverse power dissipation		$P_{ZRM}$	20	W
Non repetitive peak surge power dissipation	$t_p = 100\text{ }\mu\text{s}$ , $T_j = 25\text{ }^{\circ}\text{C}$	$P_{ZSM}$	1000	W
Junction temperature		$T_j$	175	$^{\circ}\text{C}$
Storage temperature range		$T_{stg}$	- 65 to + 175	$^{\circ}\text{C}$

### Thermal Characteristics

$T_{amb} = 25\text{ }^{\circ}\text{C}$ , unless otherwise specified

Parameter	Test condition	Symbol	Value	Unit
Junction ambient	$I = 25\text{ mm}$ , $T_L = \text{constant}$	$R_{thJA}$	30	K/W
	on PC board with spacing 37.5 mm	$R_{thJA}$	70	K/W

### Electrical Characteristics

$T_{amb} = 25\text{ }^{\circ}\text{C}$ , unless otherwise specified

Parameter	Test condition	Symbol	Min	Typ.	Max	Unit
Forward voltage	$I_F = 1\text{ A}$	$V_F$			1.2	V

### Electrical Characteristics

BZW03C...

Partnumber	Zener Voltage Range			Dynamic Resistance		Test Current	Temperature Coefficient of Zener Voltage		Reverse Leakage Current		Clamping		Stand off	
	$V_Z @ I_Z$			$r_{zj}$ and $TK_{V_Z} @ I_Z$		$I_Z$	$TC_{V_Z} @ I_{ZT}$		$I_R @ V_R$		$V_{(CL)R}^1 @ I_{RMS}$		$I_R @ V_R^2$	
	V			$\Omega$		mA	%K		$\mu A$	V	V	A	$\mu A$	V
	min	typ	max	typ	max		min	max	max		max		max	
BZW03C6V8	6.4	6.8	7.2	0.7	1.5	175	0	0.07	2000	5.1	10.3	48.5	4000	5.6
BZW03C7V5	7.0	7.5	7.9	0.7	1.5	175	0	0.07	1500	5.6	11.3	44.2	3000	6.2
BZW03C8V2	7.7	8.2	8.7	0.8	1.5	150	0.03	0.08	1200	6.2	12.3	40.6	2400	6.8
BZW03C9V1	8.5	9.1	9.6	0.9	2	150	0.03	0.08	40	6.8	13.3	37.6	100	7.5
BZW03C10	9.4	10	10.6	1	2	125	0.05	0.09	20	7.5	14.8	34	40	8.2
BZW03C11	10.4	11	11.6	1.1	2.5	125	0.05	0.1	15	8.2	15.7	31.8	30	9.1
BZW03C12	11.4	12	12.7	1.1	2.5	100	0.05	0.1	10	9.1	17.0	29.4	20	10
BZW03C13	12.4	14	14.1	1.2	2.5	100	0.05	0.1	4	10	18.9	26.4	10	11
BZW03C15	13.8	15	15.6	1.2	2.5	75	0.05	0.1	2	11	20.9	23.9	10	12
BZW03C16	15.3	16	17.1	1.3	2.5	75	0.06	0.11	2	12	22.9	21.8	10	13
BZW03C18	16.8	18	19.1	1.3	2.5	65	0.06	0.11	2	13	25.6	19.5	10	15
BZW03C20	18.8	20	21.2	1.5	3	65	0.06	0.11	2	15	28.4	17.6	10	16
BZW03C22	20.8	22	23.3	1.6	3.5	50	0.06	0.11	2	16	31.0	16.1	10	18
BZW03C24	22.8	24	25.6	1.8	3.5	50	0.06	0.11	2	18	33.8	14.8	10	20
BZW03C27	25.1	27	28.9	2.5	5	50	0.06	0.11	2	20	38.1	13.1	10	22
BZW03C30	28	30	32	4	8	40	0.06	0.11	2	22	42.2	11.8	10	24
BZW03C33	31	33	35	5	10	40	0.06	0.11	2	24	46.2	10.8	10	27
BZW03C36	34	36	38	6	11	30	0.06	0.11	2	27	50.1	10	10	30
BZW03C39	37	39	41	7	14	30	0.06	0.11	2	30	54.1	9.2	10	33
BZW03C43	40	43	46	10	20	30	0.07	0.12	2	33	60.7	8.2	10	36
BZW03C47	44	47	50	12	25	25	0.07	0.12	2	36	65.5	7.6	10	39
BZW03C51	48	51	54	14	27	25	0.07	0.12	2	39	70.8	7.0	10	43
BZW03C56	52	56	60	18	35	20	0.07	0.12	2	43	78.6	6.3	10	47
BZW03C62	58	62	66	20	42	20	0.08	0.13	2	47	86.5	5.8	10	51
BZW03C68	64	68	72	22	44	20	0.08	0.13	2	51	94.4	5.3	10	56
BZW03C75	70	75	79	25	45	20	0.08	0.13	2	56	103.5	4.8	10	62
BZW03C82	77	82	87	30	65	15	0.08	0.13	2	62	114	4.3	10	68
BZW03C91	85	91	96	40	75	15	0.09	0.13	2	68	126	3.9	10	75
BZW03C100	94	100	106	45	90	12	0.09	0.13	2	75	139	3.6	10	82
BZW03C110	104	110	116	65	125	12	0.09	0.13	2	82	152	3.3	10	91
BZW03C120	114	120	127	90	170	10	0.09	0.13	2	91	167	3.0	10	100
BZW03C130	124	130	141	100	190	10	0.09	0.13	2	100	185	2.7	10	110
BZW03C150	138	150	156	150	330	8	0.09	0.13	2	110	204	2.4	10	120
BZW03C160	153	160	171	180	350	8	0.09	0.13	2	120	224	2.2	10	130
BZW03C180	168	180	191	210	430	5	0.09	0.13	2	130	249	2.0	10	150
BZW03C200	188	200	212	250	500	5	0.09	0.13	2	150	276	1.8	10	160
BZW03C220	208	220	233	350	700	5	0.09	0.13	2	160	305	1.6	10	180
BZW03C240	228	240	256	450	900	5	0.09	0.13	2	180	336	1.5	10	200
BZW03C270	251	270	289	600	1200	5	0.09	0.13	2	200	380	1.3	10	220

<sup>1)</sup> Exp. falling pulse,  $t_p = 500 \mu s$  down to 37 %

<sup>2)</sup> Stand-off reverse voltage = recommended supply voltage



## Electrical Characteristics

BZW03D...

Partnumber	Zener Voltage Range			Dynamic Resistance		Test Current	Temperature Coefficient of Zener Voltage		Reverse Leakage Current		Clamping		Stand off	
	$V_Z @ I_Z$			$r_{zj}$ and $TK_{VZ}@I_Z$		$I_{ZT}$	@ $I_{ZT}$ , $TC_{VZ}$		$I_R @ V_R$		$V_{(CL)R}^{(1)} @ I_{RMS}$		$I_R @ V_R^{(2)}$	
	V			$\Omega$		mA	%K		$\mu A$	V	V	A	$\mu A$	V
	min	typ	max	typ	typ		min	max	max		max		max	
BZW03D6V8	6.1	6.8	7.5	0.7	1.5	175	0	0.07	2000	4.8	10.6	48.5	4000	5.3
BZW03D7V5	6.75	7.5	8.25	0.7	1.5	175	0	0.07	1500	5.3	11.7	44.2	3000	5.8
BZW03D8V2	7.4	8.2	9	0.8	1.5	150	0.03	0.08	1200	5.8	12.6	40.6	2400	6.5
BZW03D9V1	8.2	9.1	10	0.9	2	150	0.03	0.08	40	6.5	13.6	37.6	100	7.1
BZW03D10	9	10	11	1	2	125	0.05	0.09	20	7.1	15.2	34	40	7.9
BZW03D11	9.9	11	12.1	1.1	2.5	125	0.05	0.1	15	7.9	16.2	31.8	30	8.6
BZW03D12	10.8	12	13.2	1.1	2.5	100	0.05	0.1	10	8.6	17.5	29.4	20	9.3
BZW03D13	11.7	13	14.3	1.2	2.5	100	0.05	0.1	4	9.3	19.1	26.4	10	10.6
BZW03D15	13.5	15	16.5	1.2	2.5	75	0.05	0.1	2	10.6	21.8	23.9	10	11.6
BZW03D16	14.4	16	17.6	1.3	2.5	75	0.06	0.11	2	11.6	23.4	21.8	10	12.6
BZW03D18	16.2	18	19.8	1.3	2.5	65	0.06	0.11	2	12.6	26.3	19.5	10	14.4
BZW03D20	18	20	22	1.5	3	65	0.06	0.11	2	14.4	29.2	17.6	10	15.8
BZW03D22	20.8	22	24.2	1.6	3.5	50	0.06	0.11	2	15.8	32	16.1	10	17.2
BZW03D24	21.6	24	26.4	1.8	3.5	50	0.06	0.11	2	17.2	34.6	14.8	10	19.4
BZW03D27	24.3	27	29.7	2.5	5	50	0.06	0.11	2	19.4	39	13.1	10	21.5
BZW03D30	27	30	33	4	8	40	0.06	0.11	2	21.5	43.2	11.8	10	23.5
BZW03D33	29.7	33	36.3	5	10	40	0.06	0.11	2	23.5	47	10.8	10	25.8
BZW03D36	32.4	36	39.6	6	11	30	0.06	0.11	2	25.8	51.7	10	10	28
BZW03D39	25.1	39	42.9	7	14	30	0.06	0.11	2	28	56	9.2	10	31
BZW03D43	38.7	43	47.3	10	20	30	0.07	0.12	2	31	62	8.2	10	33.5
BZW03D47	42.3	47	51.7	12	25	25	0.07	0.12	2	33.5	66.7	7.6	10	36.5
BZW03D51	45.9	51	56.1	14	27	25	0.07	0.12	2	36.5	73	7.0	10	40
BZW03D56	50.4	56	61.6	18	35	20	0.07	0.12	2	40	80.2	6.3	10	44.5
BZW03D62	55.8	62	68.2	20	42	20	0.08	0.13	2	44.5	88.7	5.8	10	49
BZW03D68	61.2	68	74.8	22	44	20	0.08	0.13	2	49	97.2	5.3	10	54
BZW03D75	67.5	75	82.5	25	45	20	0.08	0.13	2	54	107	4.8	10	59
BZW03D82	73.8	82	90.2	30	65	15	0.08	0.13	2	59	117	4.3	10	65
BZW03D91	81.9	91	100	40	75	15	0.09	0.13	2	65	130	3.9	10	71
BZW03D100	90	100	110	45	90	12	0.09	0.13	2	71	143	3.6	10	79
BZW03D110	99	110	121	65	125	12	0.09	0.13	2	79	157	3.3	10	86
BZW03D120	108	120	132	90	170	10	0.09	0.13	2	86	172	3.0	10	93
BZW03D130	117	130	143	100	190	10	0.09	0.13	2	93	187	2.7	10	106
BZW03D150	135	150	165	150	330	8	0.09	0.13	2	106	213	2.4	10	116
BZW03D160	144	160	176	180	350	8	0.09	0.13	2	116	229	2.2	10	126
BZW03D180	162	180	198	210	430	5	0.09	0.13	2	126	256	2.0	10	144
BZW03D200	180	200	220	250	500	5	0.09	0.13	2	144	284	1.8	10	158
BZW03D220	198	220	242	350	700	5	0.09	0.13	2	158	314	1.6	10	172
BZW03D240	216	240	264	450	900	5	0.09	0.13	2	172	344	1.5	10	194
BZW03D270	243	270	297	600	1200	5	0.09	0.13	2	194	388	1.3	10	215

<sup>1)</sup> Exp. falling pulse,  $t_p = 500 \mu s$  down to 37 %

<sup>2)</sup> Stand-off reverse voltage = recommended supply voltage

### Typical Characteristics ( $T_{amb} = 25\text{ }^{\circ}\text{C}$ unless otherwise specified)

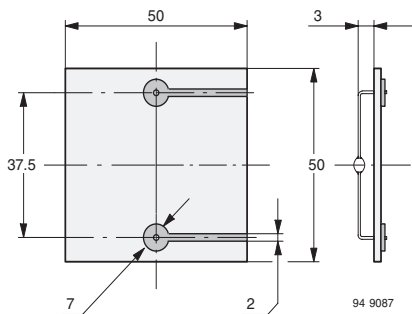

Figure 1. Epoxy Glass Hard Tissue, Board Thickness 1.5 mm,  $R_{thJA} \leq 70\text{ K/W}$

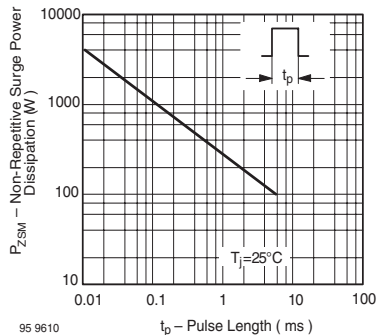

Figure 4. Non Repetitive Surge Power Dissipation vs. Pulse Length

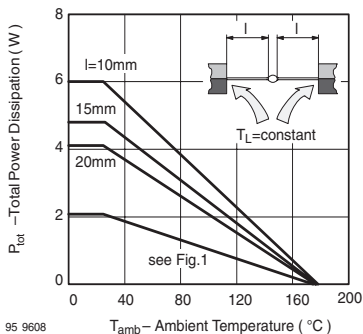

Figure 2. Total Power Dissipation vs. Ambient Temperature

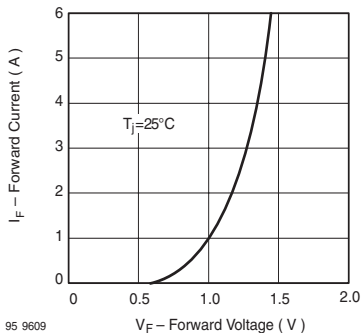

Figure 3. Forward Current vs. Forward Voltage

### SOD-64 Package Dimension see Package Section

## Small Signal Zener Diodes

### Features

- Very sharp reverse characteristic
- Low reverse current level
- Very high stability
- Low noise
- Available with tighter tolerances



### Applications

Voltage stabilization

### Mechanical Data

**Case:** DO-35 Glass case

**Weight:** approx. 125 mg

**Packaging Codes/Options:**

TR / 10 k per 13 " reel, 30 k/box

TAP / 10 k per Ammopack (52 mm tape), 30 k/box

### Absolute Maximum Ratings

$T_{amb} = 25\text{ }^{\circ}\text{C}$ , unless otherwise specified

Parameter	Test condition	Symbol	Value	Unit
Power dissipation	$l = 4\text{ mm}$ , $T_L = 25\text{ }^{\circ}\text{C}$	$P_V$	500	mW
Z-current		$I_Z$	$P_V/V_Z$	mA
Junction temperature		$T_j$	175	$^{\circ}\text{C}$
Storage temperature range		$T_{stg}$	- 65 to + 175	$^{\circ}\text{C}$

### Thermal Characteristics

$T_{amb} = 25\text{ }^{\circ}\text{C}$ , unless otherwise specified

Parameter	Test condition	Symbol	Value	Unit
Junction ambient	$l = 4\text{ mm}$ , $T_L = \text{constant}$	$R_{thJA}$	300	K/W

### Electrical Characteristics

$T_{amb} = 25\text{ }^{\circ}\text{C}$ , unless otherwise specified

Parameter	Test condition	Symbol	Min	Typ.	Max	Unit
Forward voltage	$I_F = 200\text{ mA}$	$V_F$			1.5	V

### Electrical Characteristics

#### BZX55C..

Partnumber	Zener Voltage Range <sup>1)</sup>		Dynamic Resistance		Test Current	Temperature Coefficient		Test Current	Reverse Leakage Current		
	$V_Z @ I_{ZT}$		$r_{zT} @ I_{ZT}$	$r_{zK} @ I_{ZK}$		$I_{ZT}$	TK <sub>VZ</sub>		$I_{ZK}$	$I_R @ T_{amb} = 25^\circ C$	$I_R @ T_{amb} = 150^\circ C$
	V		$\Omega$		mA		%K			mA	$\mu A$
	min	max				min	max				
BZX55C2V4	2.28	2.56	< 85	< 600	5	-0.09	-0.06	1	< 50	< 100	1
BZX55C2V7	2.5	2.9	< 85	< 600	5	-0.09	-0.06	1	< 10	< 50	1
BZX55C3V0	2.8	3.2	< 85	< 600	5	-0.08	-0.05	1	< 4	< 40	1
BZX55C3V3	3.1	3.5	< 85	< 600	5	-0.08	-0.05	1	< 2	< 40	1
BZX55C3V6	3.4	3.8	< 85	< 600	5	-0.08	-0.05	1	< 2	< 40	1
BZX55C3V9	3.7	4.1	< 85	< 600	5	-0.08	-0.05	1	< 2	< 40	1
BZX55C4V3	4	4.6	< 75	< 600	5	-0.06	-0.03	1	< 1	< 20	1
BZX55C4V7	4.4	5	< 60	< 600	5	-0.05	0.02	1	< 0.5	< 10	1
BZX55C5V1	4.8	5.4	< 35	< 550	5	-0.02	0.02	1	< 0.1	< 2	1
BZX55C5V6	5.2	6	< 25	< 450	5	-0.05	0.05	1	< 0.1	< 2	1
BZX55C6V2	5.8	6.6	< 10	< 200	5	0.03	0.06	1	< 0.1	< 2	2
BZX55C6V8	6.4	7.2	< 8	< 150	5	0.03	0.07	1	< 0.1	< 2	3
BZX55C7V5	7	7.9	< 7	< 50	5	0.03	0.07	1	< 0.1	< 2	5
BZX55C8V2	7.7	8.7	< 7	< 50	5	0.03	0.08	1	< 0.1	< 2	6.2
BZX55C9V1	8.5	9.6	< 10	< 50	5	0.03	0.09	1	< 0.1	< 2	6.8
BZX55C10	9.4	10.6	< 15	< 70	5	0.03	0.1	1	< 0.1	< 2	7.5
BZX55C11	10.4	11.6	< 20	< 70	5	0.03	0.11	1	< 0.1	< 2	8.2
BZX55C12	11.4	12.7	< 20	< 90	5	0.03	0.11	1	< 0.1	< 2	9.1
BZX55C13	12.4	14.1	< 26	< 110	5	0.03	0.11	1	< 0.1	< 2	10
BZX55C15	13.8	15.6	< 30	< 110	5	0.03	0.11	1	< 0.1	< 2	11
BZX55C16	15.3	17.1	< 40	< 170	5	0.03	0.11	1	< 0.1	< 2	12
BZX55C18	16.8	19.1	< 50	< 170	5	0.03	0.11	1	< 0.1	< 2	13
BZX55C20	18.8	21.2	< 55	< 220	5	0.03	0.11	1	< 0.1	< 2	15
BZX55C22	20.8	23.3	< 55	< 220	5	0.04	0.12	1	< 0.1	< 2	16
BZX55C24	22.8	25.6	< 80	< 220	5	0.04	0.12	1	< 0.1	< 2	18
BZX55C27	25.1	28.9	< 80	< 220	5	0.04	0.12	1	< 0.1	< 2	20
BZX55C30	28	32	< 80	< 220	5	0.04	0.12	1	< 0.1	< 2	22
BZX55C33	31	35	< 80	< 220	5	0.04	0.12	1	< 0.1	< 2	24
BZX55C36	34	38	< 80	< 220	5	0.04	0.12	1	< 0.1	< 2	27
BZX55C39	37	41	< 90	< 500	2.5	0.04	0.12	0.5	< 0.1	< 5	30
BZX55C43	40	46	< 90	< 600	2.5	0.04	0.12	0.5	< 0.1	< 5	33
BZX55C47	44	50	< 110	< 700	2.5	0.04	0.12	0.5	< 0.1	< 5	36
BZX55C51	48	54	< 125	< 700	2.5	0.04	0.12	0.5	< 0.1	< 10	39
BZX55C56	52	60	< 135	< 1000	2.5	0.04	0.12	0.5	< 0.1	< 10	43
BZX55C62	58	66	< 150	< 1000	2.5	0.04	0.12	0.5	< 0.1	< 10	47
BZX55C68	64	72	< 200	< 1000	2.5	0.04	0.12	0.5	< 0.1	< 10	51
BZX55C75	70	79	< 250	< 1500	2.5	0.04	0.12	0.5	< 0.1	< 10	56

<sup>1)</sup> Other tolerances available on request:

BZX55A...  $\pm 1\%$  of  $V_{Znom}$ , BZX55F...  $\pm 3\%$  of  $V_{Znom}$



## Electrical Characteristics

### BZX55B..

Partnumber	Zener Voltage Range <sup>1)</sup>		Dynamic Resistance		Test Current	Temperature Coefficient		Test Current	Reverse Leakage Current		
	$V_Z @ I_{ZT}$		$r_{zT} @ I_{ZT}$	$r_{zK} @ I_{ZK}$		$TK_{VZ}$	$I_{ZK}$		$I_R @ T_{amb} = 25\text{ }^\circ\text{C}$	$I_R @ T_{amb} = 150\text{ }^\circ\text{C}$	$@ V_R$
	min	max	$\Omega$		mA			min	max	mA	$\mu\text{A}$
BZX55B2V7	2.64	2.76	< 85	< 600	5	-0.09	-0.06	1	< 10	< 50	1
BZX55B3V0	2.94	3.06	< 90	< 600	5	-0.08	-0.05	1	< 4	< 40	1
BZX55B3V3	3.24	3.36	< 90	< 600	5	-0.08	-0.05	1	< 2	< 40	1
BZX55B3V6	3.52	3.68	< 90	< 600	5	-0.08	-0.05	1	< 2	< 40	1
BZX55B3V9	3.82	3.98	< 90	< 600	5	-0.08	-0.05	1	< 2	< 40	1
BZX55B4V3	4.22	4.38	< 90	< 600	5	-0.06	-0.03	1	< 1	< 20	1
BZX55B4V7	4.6	4.8	< 80	< 600	5	-0.05	0.02	1	< 0.5	< 10	1
BZX55B5V1	5	5.2	< 60	< 550	5	-0.02	0.02	1	< 0.1	< 2	1
BZX55B5V6	5.48	5.72	< 40	< 450	5	-0.05	0.05	1	< 0.1	< 2	1
BZX55B6V2	6.08	6.32	< 10	< 200	5	0.03	0.06	1	< 0.1	< 2	2
BZX55B6V8	6.66	6.94	< 8	< 150	5	0.03	0.07	1	< 0.1	< 2	3
BZX55B7V5	7.35	7.65	< 7	< 50	5	0.03	0.07	1	< 0.1	< 2	5
BZX55B8V2	8.04	8.36	< 7	< 50	5	0.03	0.08	1	< 0.1	< 2	6.2
BZX55B9V1	8.92	9.28	< 10	< 50	5	0.03	0.09	1	< 0.1	< 2	6.8
BZX55B10	9.8	10.2	< 15	< 70	5	0.03	0.1	1	< 0.1	< 2	7.5
BZX55B11	10.78	11.22	< 20	< 70	5	0.03	0.11	1	< 0.1	< 2	8.2
BZX55B12	11.76	12.24	< 20	< 90	5	0.03	0.11	1	< 0.1	< 2	9.1
BZX55B13	12.74	13.26	< 26	< 110	5	0.03	0.11	1	< 0.1	< 2	10
BZX55B15	14.7	15.3	< 30	< 110	5	0.03	0.11	1	< 0.1	< 2	11
BZX55B16	15.7	16.3	< 40	< 170	5	0.03	0.11	1	< 0.1	< 2	12
BZX55B18	17.64	18.36	< 50	< 170	5	0.03	0.11	1	< 0.1	< 2	13
BZX55B20	19.6	20.4	< 55	< 220	5	0.03	0.11	1	< 0.1	< 2	15
BZX55B22	21.55	22.45	< 55	< 220	5	0.04	0.12	1	< 0.1	< 2	16
BZX55B24	23.5	24.5	< 80	< 220	5	0.04	0.12	1	< 0.1	< 2	18
BZX55B27	26.4	27.6	< 80	< 220	5	0.04	0.12	1	< 0.1	< 2	20
BZX55B30	29.4	30.6	< 80	< 220	5	0.04	0.12	1	< 0.1	< 2	22
BZX55B33	32.4	33.6	< 80	< 220	5	0.04	0.12	1	< 0.1	< 2	24
BZX55B36	35.3	36.7	< 80	< 220	5	0.04	0.12	1	< 0.1	< 2	27
BZX55B39	38.2	39.8	< 90	< 500	2.5	0.04	0.12	0.5	< 0.1	< 5	30
BZX55B43	42.1	43.9	< 90	< 600	2.5	0.04	0.12	0.5	< 0.1	< 5	33
BZX55B47	46.1	47.9	< 110	< 700	2.5	0.04	0.12	0.5	< 0.1	< 5	36
BZX55B51	50	52	< 125	< 700	2.5	0.04	0.12	0.5	< 0.1	< 10	39
BZX55B56	54.9	57.1	< 135	< 1000	2.5	0.04	0.12	0.5	< 0.1	< 10	43
BZX55B62	60.8	63.2	< 150	< 1000	2.5	0.04	0.12	0.5	< 0.1	< 10	47
BZX55B68	66.6	69.4	< 200	< 1000	2.5	0.04	0.12	0.5	< 0.1	< 10	51
BZX55B75	73	76.5	< 250	< 1500	2.5	0.04	0.12	0.5	< 0.1	< 10	56

<sup>1)</sup> Other tolerances available on request:  
 BZX55A...  $\pm 1\%$  of  $V_{Znom}$ , BZX55F...  $\pm 3\%$  of  $V_{Znom}$



### Typical Characteristics ( $T_{amb} = 25\text{ }^{\circ}\text{C}$ unless otherwise specified)

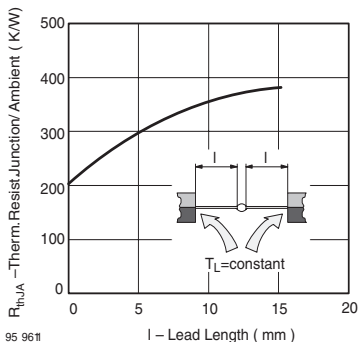

Figure 1. Thermal Resistance vs. Lead Length

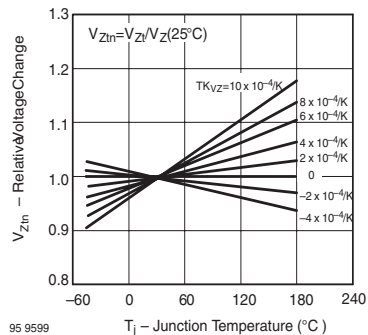

Figure 4. Typical Change of Working Voltage vs. Junction Temperature

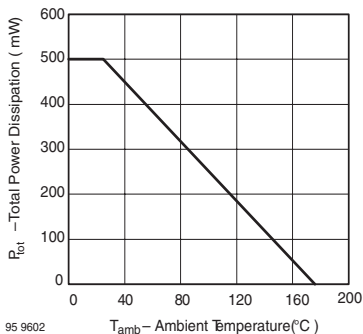

Figure 2. Total Power Dissipation vs. Ambient Temperature

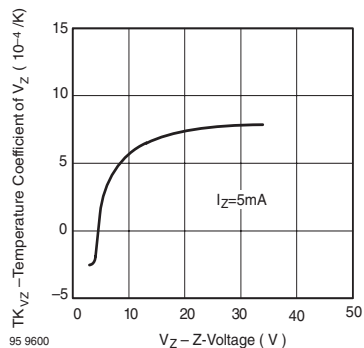

Figure 5. Temperature Coefficient of  $V_Z$  vs. Z-Voltage

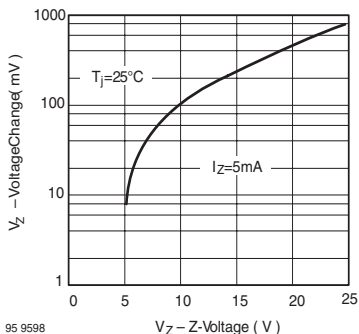

Figure 3. Typical Change of Working Voltage under Operating Conditions at  $T_{amb}=25\text{ }^{\circ}\text{C}$

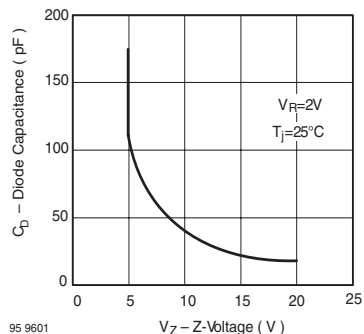

Figure 6. Diode Capacitance vs. Z-Voltage

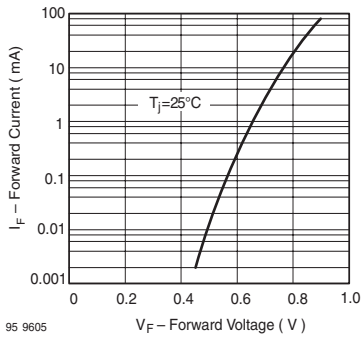

Figure 7. Forward Current vs. Forward Voltage

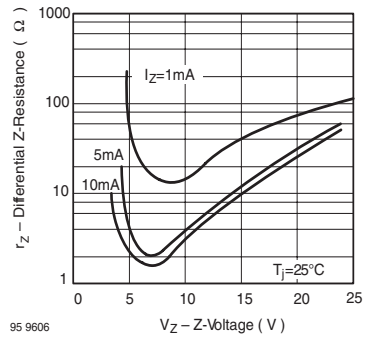

Figure 10. Differential Z-Resistance vs. Z-Voltage

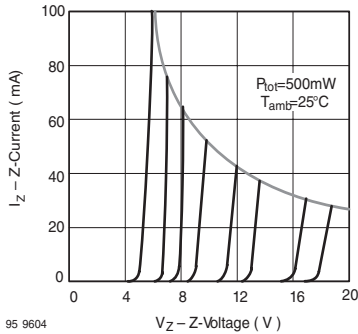

Figure 8. Z-Current vs. Z-Voltage

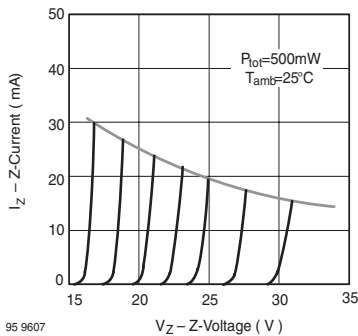

Figure 9. Z-Current vs. Z-Voltage

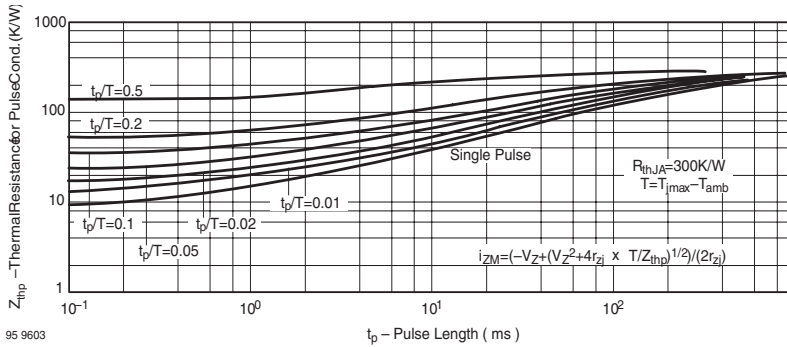

Figure 11. Thermal Response

**DO-35 Package Dimension**  
**see Package Section**

## Small Signal Zener Diodes

### Features

- These diodes are also available in other case styles and other configurations including: the SOD-123 case with type designation BZT52 series, the dual zener diode common anode configuration in the SOT-23 case with type designation AZ23 series and the dual zener diode common cathode configuration in the SOT-23 case with type designation DZ23 series.

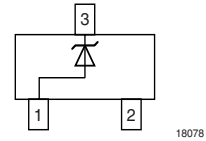
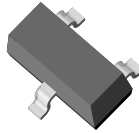

- The Zener voltages are graded according to the international E 24 standard. Standard Zener voltage tolerance is  $\pm 5\%$ . Replace "C" with "B" for  $\pm 2\%$  tolerance.
- Silicon Planar Power Zener Diodes

### Mechanical Data

**Case:** SOT-23 Plastic case

**Weight:** approx. 8.8 mg

**Packaging Codes/Options:**

GS18 / 10 k per 13" reel (8 mm tape), 10 k/box

GS08 / 3 k per 7" reel (8 mm tape), 15 k/box

### Absolute Maximum Ratings

$T_{amb} = 25\text{ }^{\circ}\text{C}$ , unless otherwise specified

Parameter	Test condition	Symbol	Value	Unit
Power dissipation		$P_{tot}$	300 <sup>1)</sup>	mW

<sup>1)</sup> Device on fiberglass substrate, see layout.

### Thermal Characteristics

$T_{amb} = 25\text{ }^{\circ}\text{C}$ , unless otherwise specified

Parameter	Test condition	Symbol	Value	Unit
Thermal resistance junction to ambient air		$R_{thJA}$	420 <sup>1)</sup>	$^{\circ}\text{C/W}$
Junction temperature		$T_j$	150	$^{\circ}\text{C}$
Storage temperature range		$T_S$	- 65 to + 150	$^{\circ}\text{C}$

<sup>1)</sup> Device on fiberglass substrate, see layout.



## Electrical Characteristics

Partnumber	Marking Code	Zener Voltage Range		Dynamic Resistance		Test Current	Temp. Coefficient of Zener Voltage		Test Current	Reverse Leakage Current			
		$V_Z @ I_{ZT1}$		$r_{zj} @ I_{ZT1}$	$r_{zj} @ I_{ZT2}$		$I_{ZT1}$	$\alpha_{VZ} @ I_{ZT1}$		$I_{ZT2}$	$I_R$	@ $V_R$	
		V		$\Omega$			mA	$10^{-4}/^{\circ}C$		mA	$\mu A$	V	
		min	max				min	max					
BZX84C2V4	Z11	2.2	2.6	70 ( $\leq 100$ )	275	5	-9.0	-4.0	1	50	1		
BZX84C2V7	Z12	2.5	2.9	75 ( $\leq 100$ )	300 ( $\leq 600$ )	5	-9.0	-4.0	1	20	1		
BZX84C3	Z13	2.8	3.2	80 ( $\leq 95$ )	325 ( $\leq 600$ )	5	-9.0	-3.0	1	10	1		
BZX84C3V3	Z14	3.1	3.5	85 ( $\leq 95$ )	350 ( $\leq 600$ )	5	-8.0	-3.0	1	5	1		
BZX84C3V6	Z15	3.4	3.8	85 ( $\leq 90$ )	375 ( $\leq 600$ )	5	-8.0	-3.0	1	5	1		
BZX84C3V9	Z16	3.7	4.1	85 ( $\leq 90$ )	400 ( $\leq 600$ )	5	-7.0	-3.0	1	3	1		
BZX84C4V3	Z17	4	4.6	80 ( $\leq 90$ )	410 ( $\leq 600$ )	5	-6.0	-1.0	1	3	1		
BZX84C4V7	Z1	4.4	5	50 ( $\leq 80$ )	425 ( $\leq 500$ )	5	-5.0	+2.0	1	3	2		
BZX84C5V1	Z2	4.8	5.4	40 ( $\leq 60$ )	400 ( $\leq 480$ )	5	-3.0	+4.0	1	2	2		
BZX84C5V6	Z3	5.2	6	15 ( $\leq 40$ )	80 ( $\leq 400$ )	5	-2.0	+6.0	1	1	2		
BZX84C6V2	Z4	5.8	6.6	6.0 ( $\leq 10$ )	40 ( $\leq 150$ )	5	-1.0	+7.0	1	3	4		
BZX84C6V8	Z5	6.4	7.2	6.0 ( $\leq 15$ )	30 ( $\leq 80$ )	5	+2.0	+7.0	1	2	4		
BZX84C7V5	Z6	7	7.9	6.0 ( $\leq 15$ )	30 ( $\leq 80$ )	5	+3.0	+7.0	1	1	5		
BZX84C8V2	Z7	7.7	8.7	6.0 ( $\leq 15$ )	40 ( $\leq 80$ )	5	+4.0	+7.0	1	0.7	5		
BZX84C9V1	Z8	8.5	9.6	6.0 ( $\leq 15$ )	40 ( $\leq 100$ )	5	+5.0	+8.0	1	0.5	6		
BZX84C10	Z9	9.4	10.6	8.0 ( $\leq 20$ )	50 ( $\leq 150$ )	5	+5.0	+8.0	1	0.2	7		
BZX84C11	Y1	10.4	11.6	10 ( $\leq 20$ )	50 ( $\leq 150$ )	5	+5.0	+9.0	1	0.1	8		
BZX84C12	Y2	11.4	12.7	10 ( $\leq 25$ )	50 ( $\leq 150$ )	5	+6.0	+9.0	1	0.1	8		
BZX84C13	Y3	12.4	14.1	10 ( $\leq 30$ )	50 ( $\leq 170$ )	5	+7.0	+9.0	1	0.1	8		
BZX84C15	Y4	13.8	15.6	10 ( $\leq 30$ )	50 ( $\leq 200$ )	5	+7.0	+9.0	1	0.05	0.7 $V_{Znom}$		
BZX84C16	Y5	15.3	17.1	10 ( $\leq 40$ )	50 ( $\leq 200$ )	5	+8.0	+9.5	1	0.05	0.7 $V_{Znom}$		
BZX84C18	Y6	16.8	19.1	10 ( $\leq 45$ )	50 ( $\leq 225$ )	5	+8.0	+9.5	1	0.05	0.7 $V_{Znom}$		
BZX84C20	Y7	18.8	21.2	15 ( $\leq 55$ )	60 ( $\leq 225$ )	5	+8.0	+10	1	0.05	0.7 $V_{Znom}$		
BZX84C22	Y8	20.8	23.3	20 ( $\leq 55$ )	60 ( $\leq 250$ )	5	+8.0	+10	1	0.05	0.7 $V_{Znom}$		
BZX84C24	Y9	22.8	25.6	25 ( $\leq 70$ )	60 ( $\leq 250$ )	5	+8.0	+10	1	0.05	0.7 $V_{Znom}$		
BZX84C27	Y10	25.1	28.9	25 ( $\leq 80$ )	65 ( $\leq 300$ )	2	+8.0	+10	0.5	0.05	0.7 $V_{Znom}$		
BZX84C30	Y11	28	32	30 ( $\leq 80$ )	70 ( $\leq 300$ )	2	+8.0	+10	0.5	0.05	0.7 $V_{Znom}$		
BZX84C33	Y12	31	35	35 ( $\leq 80$ )	75 ( $\leq 325$ )	2	+8.0	+10	0.5	0.05	0.7 $V_{Znom}$		
BZX84C36	Y13	34	38	35 ( $\leq 90$ )	80 ( $\leq 350$ )	2	+8.0	+10	0.5	0.05	0.7 $V_{Znom}$		
BZX84C39	Y14	37	41	40 ( $\leq 130$ )	80 ( $\leq 350$ )	2	+10	+12	0.5	0.05	0.7 $V_{Znom}$		
BZX84C43	Y15	40	46	45 ( $\leq 150$ )	85 ( $\leq 375$ )	2	+10	+12	0.5	0.05	0.7 $V_{Znom}$		
BZX84C47	Y16	44	50	50 ( $\leq 170$ )	85 ( $\leq 375$ )	2	+10	+12	0.5	0.05	0.7 $V_{Znom}$		
BZX84C51	Y17	48	54	60 ( $\leq 180$ )	85 ( $\leq 400$ )	2	+10	+12	0.5	0.05	0.7 $V_{Znom}$		
BZX84C56	Y18	52	60	70 ( $\leq 200$ )	100 ( $\leq 425$ )	2	+9.0	+11	0.5	0.05	0.7 $V_{Znom}$		
BZX84C62	Y19	58	66	80 ( $\leq 215$ )	100 ( $\leq 450$ )	2	+9.0	+12	0.5	0.05	0.7 $V_{Znom}$		
BZX84C68	Y20	64	72	90 ( $\leq 240$ )	150 ( $\leq 475$ )	2	+10	+12	0.5	0.05	0.7 $V_{Znom}$		
BZX84C75	Y21	70	79	95 ( $\leq 255$ )	170 ( $\leq 500$ )	2	+10	+12	0.5	0.05	0.7 $V_{Znom}$		



## Electrical Characteristics

Partnumber	Marking Code	Zener Voltage Range		Dynamic Resistance		Test Current	Temp. Coefficient of Zener Voltage		Test Current	Reverse Leakage Current	
		$V_Z @ I_{ZT1}$		$r_{zj} @ I_{ZT1}$	$r_{zj} @ I_{ZT2}$		$I_{ZT1}$	$\alpha_{VZ} @ I_{ZT1}$		$I_{ZT2}$	$I_R$
		V		$\Omega$		mA	$10^{-4}/^{\circ}\text{C}$		mA	$\mu\text{A}$	V
		min	max				min	max			
BZX84B2V4	Z50	2.35	2.45	70 ( $\leq 100$ )	275	5	-9	-4	1	50	1
BZX84B2V7	Z51	2.65	2.75	75 ( $\leq 100$ )	300 ( $\leq 600$ )	5	-9	-4	1	20	1
BZX84B3	Z52	2.94	3.06	80 ( $\leq 95$ )	325 ( $\leq 600$ )	5	-9	-3	1	10	1
BZX84B3V3	Z53	3.23	3.37	85 ( $\leq 95$ )	350 ( $\leq 600$ )	5	-8	-3	1	5	1
BZX84B3V6	Z54	3.53	3.67	85 ( $\leq 90$ )	375 ( $\leq 600$ )	5	-8	-3	1	5	1
BZX84B3V9	Z55	3.82	3.98	85 ( $\leq 90$ )	400 ( $\leq 600$ )	5	-7	-3	1	3	1
BZX84B4V3	Z56	4.21	4.39	80 ( $\leq 90$ )	410 ( $\leq 600$ )	5	-6	-1	1	3	1
BZX84B4V7	Z57	4.61	4.79	50 ( $\leq 80$ )	425 ( $\leq 500$ )	5	-5	2	1	3	2
BZX84B5V1	Z58	5	5.2	40 ( $\leq 60$ )	400 ( $\leq 480$ )	5	-3	4	1	2	2
BZX84B5V6	Z59	5.49	5.71	15 ( $\leq 40$ )	80 ( $\leq 400$ )	5	-2	6	1	1	2
BZX84B6V2	Z60	6.08	6.32	6.0 ( $\leq 10$ )	40 ( $\leq 150$ )	5	-1	7	1	3	4
BZX84B6V8	Z61	6.66	6.94	6.0 ( $\leq 15$ )	30 ( $\leq 80$ )	5	2	7	1	2	4
BZX84B7V5	Z62	7.35	7.65	6.0 ( $\leq 15$ )	30 ( $\leq 80$ )	5	3	7	1	1	5
BZX84B8V2	Z63	8.04	8.36	6.0 ( $\leq 15$ )	40 ( $\leq 80$ )	5	4	7	1	0.7	5
BZX84B9V1	Z64	8.92	9.28	6.0 ( $\leq 15$ )	40 ( $\leq 100$ )	5	5	8	1	0.5	6
BZX84B10	Z65	9.8	10.2	8.0 ( $\leq 20$ )	50 ( $\leq 150$ )	5	5	8	1	0.2	7
BZX84B11	Z66	10.8	11.2	10 ( $\leq 20$ )	50 ( $\leq 150$ )	5	5	9	1	0.1	8
BZX84B12	Z67	11.8	12.2	10 ( $\leq 25$ )	50 ( $\leq 150$ )	5	6	9	1	0.1	8
BZX84B13	Z68	12.7	13.3	10 ( $\leq 30$ )	50 ( $\leq 170$ )	5	7	9	1	0.1	8
BZX84B15	Z69	14.7	15.3	10 ( $\leq 30$ )	50 ( $\leq 200$ )	5	7	9	1	0.05	$0.7 V_{Znom.}$
BZX84B16	Z70	15.7	16.3	10 ( $\leq 40$ )	50 ( $\leq 200$ )	5	8	9.5	1	0.05	$0.7 V_{Znom.}$
BZX84B18	Z71	17.6	18.4	10 ( $\leq 45$ )	50 ( $\leq 225$ )	5	8	9.5	1	0.05	$0.7 V_{Znom.}$
BZX84B20	Z72	19.6	20.4	15 ( $\leq 55$ )	60 ( $\leq 225$ )	5	8	10	1	0.05	$0.7 V_{Znom.}$
BZX84B22	Z73	21.6	22.4	20 ( $\leq 55$ )	60 ( $\leq 250$ )	5	8	10	1	0.05	$0.7 V_{Znom.}$
BZX84B24	Z74	23.5	24.5	25 ( $\leq 70$ )	60 ( $\leq 250$ )	5	8	10	1	0.05	$0.7 V_{Znom.}$
BZX84B27	Z75	26.5	27.5	25 ( $\leq 80$ )	65 ( $\leq 300$ )	2	8	10	0.5	0.05	$0.7 V_{Znom.}$
BZX84B30	Z76	29.4	30.6	30 ( $\leq 80$ )	70 ( $\leq 300$ )	2	8	10	0.5	0.05	$0.7 V_{Znom.}$
BZX84B33	Z77	32.3	33.7	35 ( $\leq 80$ )	75 ( $\leq 325$ )	2	8	10	0.5	0.05	$0.7 V_{Znom.}$
BZX84B36	Z78	35.3	36.7	35 ( $\leq 90$ )	80 ( $\leq 350$ )	2	8	10	0.5	0.05	$0.7 V_{Znom.}$
BZX84B39	Z79	38.2	39.8	40 ( $\leq 130$ )	80 ( $\leq 350$ )	2	10	12	0.5	0.05	$0.7 V_{Znom.}$
BZX84B43	Z80	42.1	43.9	45 ( $\leq 150$ )	85 ( $\leq 375$ )	2	10	12	0.5	0.05	$0.7 V_{Znom.}$
BZX84B47	Z81	46.1	47.9	50 ( $\leq 170$ )	85 ( $\leq 375$ )	2	10	12	0.5	0.05	$0.7 V_{Znom.}$
BZX84B51	Z82	50	52	60 ( $\leq 180$ )	85 ( $\leq 400$ )	2	10	12	0.5	0.05	$0.7 V_{Znom.}$
BZX84B56	Z83	54.9	57.1	70 ( $\leq 200$ )	100 ( $\leq 425$ )	2	9	11	0.5	0.05	$0.7 V_{Znom.}$
BZX84B62	Z84	60.8	63.2	80 ( $\leq 215$ )	100 ( $\leq 450$ )	2	9	12	0.5	0.05	$0.7 V_{Znom.}$
BZX84B68	Z85	66.6	69.4	90 ( $\leq 240$ )	150 ( $\leq 475$ )	2	10	12	0.5	0.05	$0.7 V_{Znom.}$
BZX84B75	Z86	73.5	76.5	95 ( $\leq 255$ )	170 ( $\leq 500$ )	2	10	12	0.5	0.05	$0.7 V_{Znom.}$

## Typical Characteristics ( $T_{amb} = 25\text{ }^{\circ}\text{C}$ unless otherwise specified)

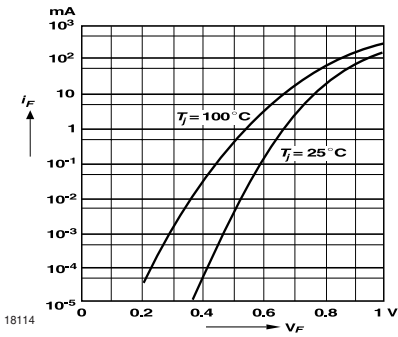

Figure 1. Forward characteristics

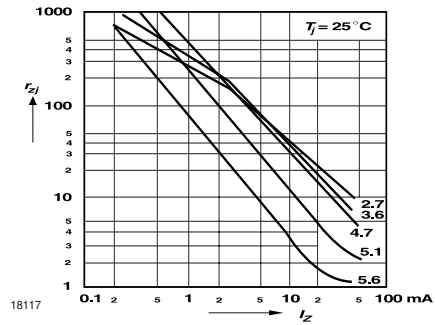

Figure 4. Dynamic Resistance vs. Zener Current

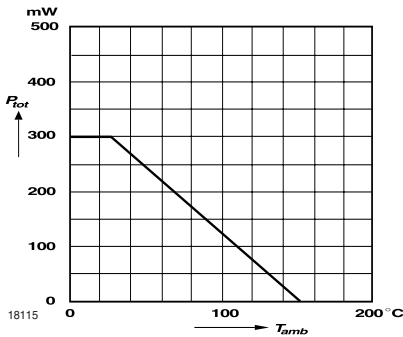

Figure 2. Admissible Power Dissipation vs. Ambient Temperature

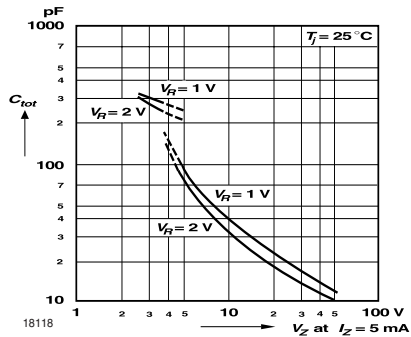

Figure 5. Capacitance vs. Zener Voltage

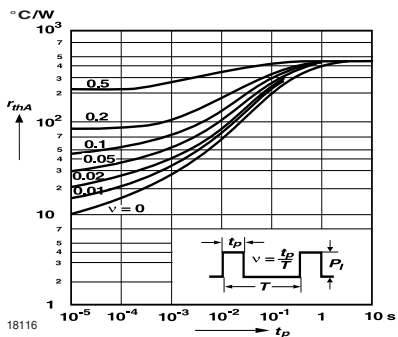

Figure 3. Pulse Thermal Resistance vs. Pulse Duration

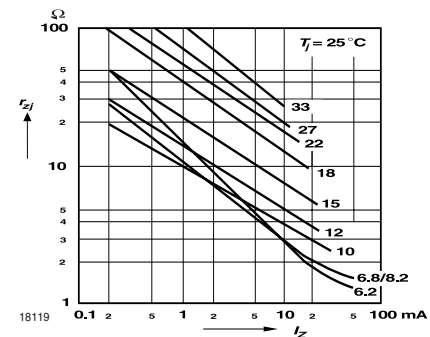

Figure 6. Dynamic Resistance vs. Zener Current

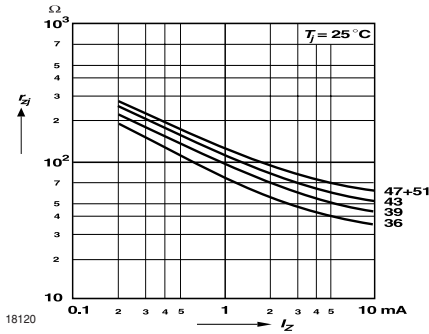

Figure 7. Dynamic Resistance vs. Zener Current

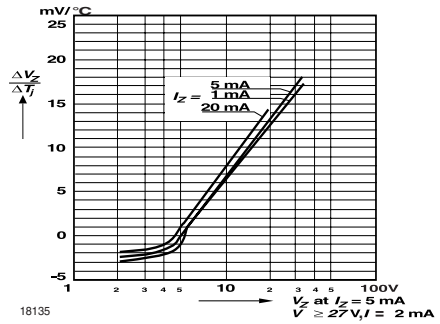

Figure 10. Temperature Dependence of Zener Voltage vs. Zener Voltage

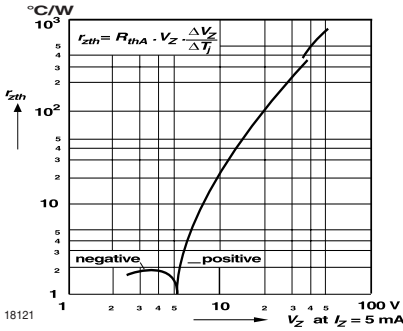

Figure 8. Thermal Differential Resistance vs. Zener Voltage

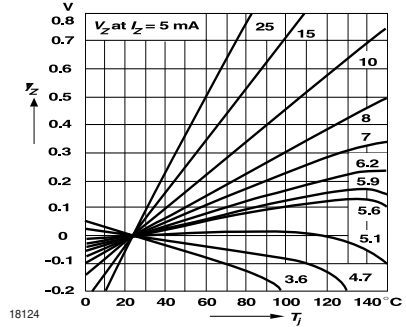

Figure 11. Change of Zener Voltage vs. Junction Temperature

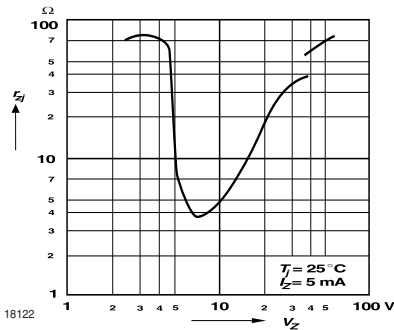

Figure 9. Dynamic Resistance vs. Zener Voltage

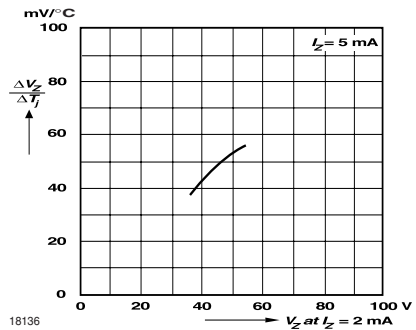

Figure 12. Temperature Dependence of Zener Voltage vs. Zener Voltage



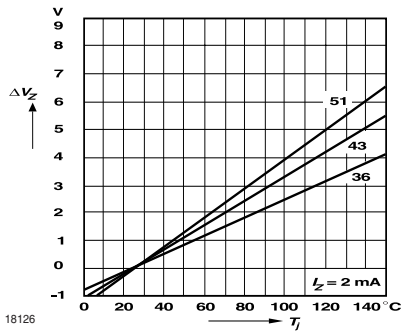

Figure 13. Change of Zener Voltage vs. Junction Temperature

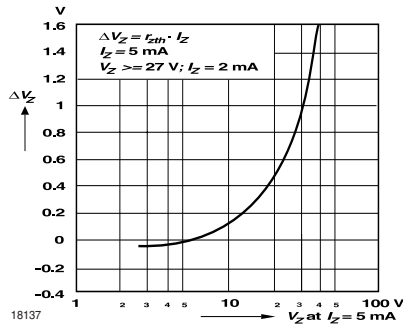

Figure 14. Change of Zener voltage from turn-on up to the point of thermal equilibrium vs. Zener voltage

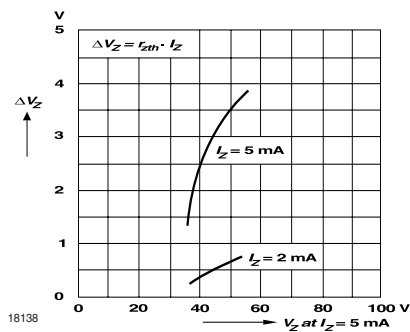

Figure 15. Change of Zener voltage from turn-on up to the point of thermal equilibrium vs. Zener voltage

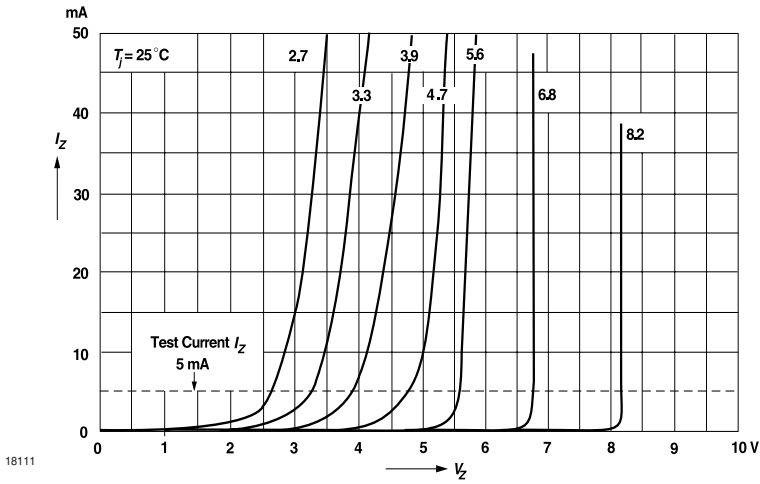

Figure 16. Breakdown Characteristics

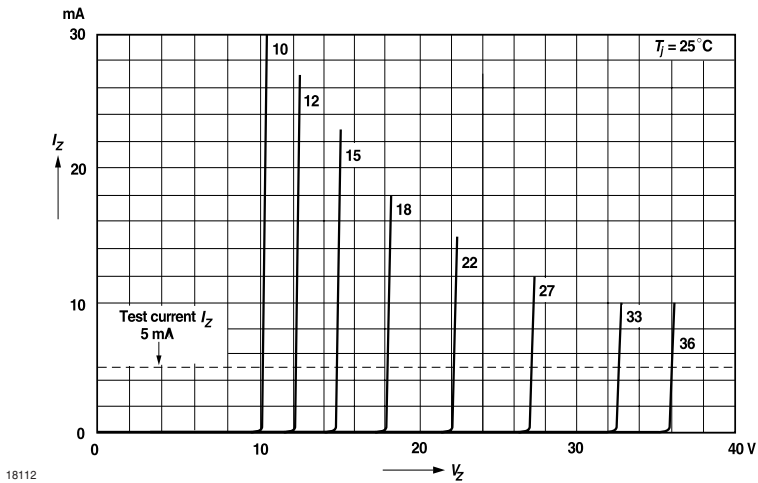
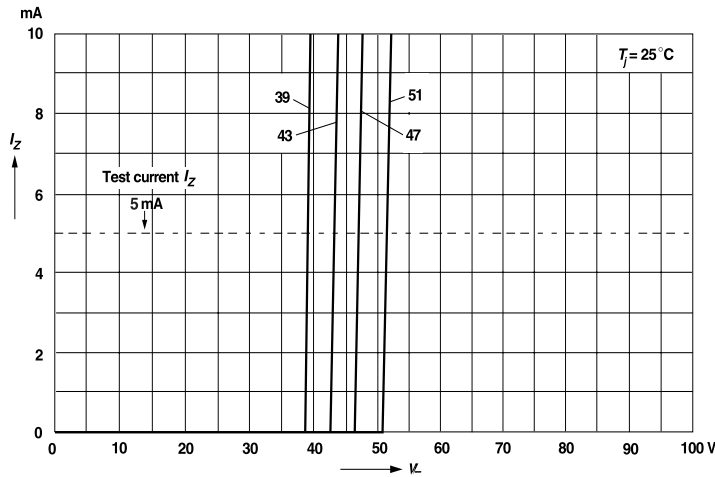

Figure 17. Breakdown Characteristics



18113

Figure 18. Breakdown Characteristics

### Layout for $R_{\text{Theta}}; \text{JA}$ test

Thickness: Fiberglass 0.059 in. (1.5 mm)

Copper leads 0.012 in. (0.3 mm)

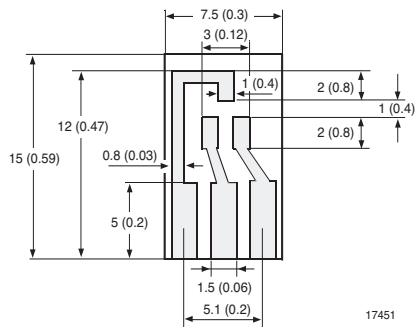

17451

### SOT-23 Package Dimension see Package Section

## Zener Diodes

### Features

- Silicon Planar Power Zener Diodes.
- For use in stabilizing and clipping circuits with high power rating.
- The Zener voltages are graded according to the international E 24 standard. Replace suffix "C" with "B" for  $\pm 2\%$  tolerance.

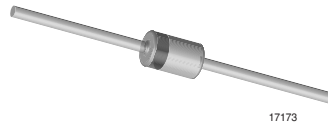

### Applications

Voltage stabilization

### Mechanical Data

**Case:** DO-41 Glass case

**Weight:** approx. 310 mg

**Packaging Codes/Options:**

TR / 5 k per 13" reel (52 mm tape), 25 k/box

TAP / 5 k per ammo pack (52 mm tape), 25 k/box

### Absolute Maximum Ratings

$T_{amb} = 25\text{ }^{\circ}\text{C}$ , unless otherwise specified

Parameter	Test condition	Symbol	Value	Unit
Zener current (see Table "Electrical Characteristics")				
Power dissipation		$P_{tot}$	1.3 <sup>1)</sup>	W

<sup>1)</sup> Valid provided that leads at a distance of 10 mm from case are kept at ambient temperature

### Thermal Characteristics

$T_{amb} = 25\text{ }^{\circ}\text{C}$ , unless otherwise specified

Parameter	Test condition	Symbol	Value	Unit
Thermal resistance junction to ambient air		$R_{thJA}$	130 <sup>1)</sup>	$^{\circ}\text{C/W}$
Junction temperature		$T_j$	175	$^{\circ}\text{C}$
Storage temperature		$T_S$	- 55 to + 175	$^{\circ}\text{C}$

<sup>1)</sup> Valid provided that leads at a distance of 10 mm from case are kept at ambient temperature



### Electrical Characteristics

Partnumber	Zener Voltage Range <sup>1)</sup>		Dynamic Resistance				Temperature Coefficient of Zener Voltage		Reverse Leakage Current		Admissible Zener Current <sup>2)</sup>
	$V_Z @ I_{ZT}$		$r_{ZT}^{(3)}$	@ $I_{ZT}$	$r_{ZK}^{(3)}$	@ $I_{ZK}$	$\alpha_{VZ} @ I_Z = I_{ZT}$		@ $I_R$	@ $V_R$	$I_Z$
	V		$\Omega$	mA	$\Omega$	mA	%/°C		$\mu A$	V	mA
	min	max					min	max			
BZX85C2V7	2.5	2.9	< 20	80	< 400	1	-0.08	-0.05	< 150	1	360
BZX85C3V0	2.8	3.2	< 20	80	< 400	1	-0.08	-0.05	< 100	1	330
BZX85C3V3	3.1	3.5	< 20	80	< 400	1	-0.08	-0.05	< 40	1	300
BZX85C3V6	3.4	3.8	< 20	60	< 500	1	-0.08	-0.05	< 20	1	290
BZX85C3V9	3.7	4.1	< 15	60	< 500	1	-0.07	-0.02	< 10	1	280
BZX85C4V3	4	4.6	< 13	50	< 500	1	-0.05	0.01	< 3	1	250
BZX85C4V7	4.4	5	< 13	45	< 600	1	-0.03	0.04	< 3	1	215
BZX85C5V1	4.8	5.4	< 10	45	< 500	1	-0.01	0.04	< 1	1.5	200
BZX85C5V6	5.2	6	< 7	45	< 400	1	0	0.045	< 1	2	190
BZX85C6V2	5.8	6.6	< 4	35	< 300	1	0.01	0.055	< 1	3	170
BZX85C6V8	6.4	7.2	< 3.5	35	< 300	1	0.015	0.06	< 1	4	155
BZX85C7V5	7	7.9	< 3	35	< 200	0.5	0.02	0.065	< 1	4.5	140
BZX85C8V2	7.7	8.7	< 5	25	< 200	0.5	0.03	0.07	< 1	6.2	130
BZX85C9V1	8.5	9.6	< 5	25	< 200	0.5	0.035	0.075	< 1	6.8	120
BZX85C10	9.4	10.6	< 7	25	< 200	0.5	0.04	0.08	< 0.5	7.5	105
BZX85C11	10.4	11.6	< 8	20	< 300	0.5	0.045	0.08	< 0.5	8.2	97
BZX85C12	11.4	12.7	< 9	20	< 350	0.5	0.045	0.085	< 0.5	9.1	88
BZX85C13	12.4	14.1	< 10	20	< 400	0.5	0.05	0.085	< 0.5	10	79
BZX85C15	13.8	15.6	< 15	15	< 500	0.5	0.055	0.09	< 0.5	11	71
BZX85C16	15.3	17.1	< 15	15	< 500	0.5	0.055	0.09	< 0.5	12	66
BZX85C18	16.8	19.1	< 20	15	< 500	0.5	0.06	0.09	< 0.5	13	62
BZX85C20	18.8	21.2	< 24	10	< 600	0.5	0.06	0.09	< 0.5	15	56
BZX85C22	20.8	23.3	< 25	10	< 600	0.5	0.06	0.095	< 0.5	16	52
BZX85C24	22.8	25.6	< 25	10	< 600	0.5	0.06	0.095	< 0.5	18	47
BZX85C27	25.1	28.9	< 30	8	< 750	0.25	0.06	0.095	< 0.5	20	41
BZX85C30	28	32	< 30	8	< 1000	0.25	0.06	0.095	< 0.5	22	36
BZX85C33	31	35	< 35	8	< 1000	0.25	0.06	0.095	< 0.5	24	33
BZX85C36	34	38	< 40	8	< 1000	0.25	0.06	0.095	< 0.5	27	30
BZX85C39	37	41	< 50	6	< 1000	0.25	0.06	0.095	< 0.5	30	28
BZX85C43	40	46	< 50	6	< 1000	0.25	0.06	0.095	< 0.5	33	26
BZX85C47	44	50	< 90	4	< 1500	0.25	0.06	0.095	< 0.5	36	23
BZX85C51	48	54	< 115	4	< 1500	0.25	0.06	0.095	< 0.5	39	21
BZX85C56	52	60	< 120	4	< 2000	0.25	0.06	0.095	< 0.5	43	19
BZX85C62	58	66	< 125	4	< 2000	0.25	0.06	0.095	< 0.5	47	16
BZX85C68	64	72	< 130	4	< 2000	0.25	0.055	0.095	< 0.5	51	15
BZX85C75	70	80	< 135	4	< 2000	0.25	0.055	0.095	< 0.5	56	14
BZX85C82	77	87	< 200	2.7	< 3000	0.25	0.055	0.095	< 0.5	62	12
BZX85C91	85	96	< 250	2.7	< 3000	0.25	0.055	0.095	< 0.5	68	10
BZX85C100	96	106	< 350	2.7	< 3000	0.25	0.055	0.095	< 0.5	75	9.4
BZX85C110	104	116	< 450	2.7	< 4000	0.25	0.055	0.095	< 0.5	82	8.6
BZX85C120	114	127	< 550	2	< 4500	0.25	0.055	0.095	< 0.5	91	7.8
BZX85C130	124	141	< 700	2	< 5000	0.25	0.055	0.095	< 0.5	100	7
BZX85C150	138	156	< 1000	2	< 6000	0.25	0.055	0.095	< 0.5	110	6.4



Partnumber	Zener Voltage Range <sup>1)</sup>		Dynamic Resistance				Temperature Coefficient of Zener Voltage		Reverse Leakage Current		Admissible Zener Current <sup>2)</sup>
			$r_{ZT}^{3)}$	@ $I_{ZT}$	$r_{ZK}^{3)}$	@ $I_{ZK}$	$\alpha_{VZ}$ @ $I_Z = I_{ZT}$	@ $I_R$	@ $V_R$	$I_Z$	
	V		$\Omega$	mA	$\Omega$	mA	%/ $^{\circ}$ C		$\mu$ A	V	mA
	min	max					min	max			
BZX85C160	153	171	< 1100	1.5	< 6500	0.25	0.055	0.095	< 0.5	120	5.8
BZX85C180	168	191	< 1200	1.5	< 7000	0.25	0.055	0.095	< 0.5	130	5.2
BZX85C200	188	212	< 1500	1.5	< 8000	0.25	0.055	0.095	< 0.5	150	4.7

<sup>1)</sup> Measured with pulses  $t_p = 5$  ms

<sup>2)</sup> Valid provided that leads are kept at ambient temperature at a distance of 10 mm from case

<sup>3)</sup> Measured with  $f = 1$  kHz



### Electrical Characteristics

Partnumber	Zener Voltage Range <sup>1)</sup>		Dynamic Resistance				Temperature Coefficient of Zener Voltage		Reverse Leakage Current		Admissible Zener Current <sup>2)</sup>
	$V_Z @ I_{ZT}$		$r_{ZT}$ <sup>3)</sup>	@ $I_{ZT}$	$r_{ZK}$ <sup>3)</sup>	@ $I_{ZK}$	$\alpha_{VZ} @ I_Z = I_{ZT}$		@ $I_R$	@ $V_R$	$I_Z$
	V		$\Omega$	mA	$\Omega$	mA	%/°C		$\mu A$	V	mA
	min	max					min	max			
BZX85B2V7	2.64	2.76	< 20	80	< 400	1	-0.08	-0.05	< 150	1	360
BZX85B3V0	2.94	3.06	< 20	80	< 400	1	-0.08	-0.05	< 100	1	330
BZX85B3V3	2.24	3.36	< 20	80	< 400	1	-0.08	-0.05	< 40	1	300
BZX85B3V6	3.53	3.67	< 20	60	< 500	1	-0.08	-0.05	< 20	1	290
BZX85B3V9	3.82	3.98	< 15	60	< 500	1	-0.07	-0.02	< 10	1	280
BZX85B4V3	4.21	4.39	< 13	50	< 500	1	-0.05	0.01	< 3	1	250
BZX85B4V7	4.61	4.79	< 13	45	< 600	1	-0.03	0.04	< 3	1	215
BZX85B5V1	5	5.2	< 10	45	< 500	1	-0.01	0.04	< 1	1.5	200
BZX85B5V6	5.49	5.71	< 7	45	< 400	1	0	0.045	< 1	2	190
BZX85B6V2	6.08	6.32	< 4	35	< 300	1	0.01	0.055	< 1	3	170
BZX85B6V8	6.66	6.94	< 3.5	35	< 300	1	0.015	0.06	< 1	4	155
BZX85B7V5	7.35	7.65	< 3	35	< 200	0.5	0.02	0.065	< 1	4.5	140
BZX85B8V2	8.04	8.36	< 5	25	< 200	0.5	0.03	0.07	< 1	6.2	130
BZX85B9V1	8.92	9.28	< 5	25	< 200	0.5	0.035	0.075	< 1	6.8	120
BZX85B10	9.8	10.2	< 7	25	< 200	0.5	0.04	0.08	< 0.5	7.5	105
BZX85B11	10.8	11.2	< 8	20	< 300	0.5	0.045	0.08	< 0.5	8.2	97
BZX85B12	11.8	12.2	< 9	20	< 350	0.5	0.045	0.085	< 0.5	9.1	88
BZX85B13	12.7	13.3	< 10	20	< 400	0.5	0.05	0.085	< 0.5	10	79
BZX85B15	14.7	15.3	< 15	15	< 500	0.5	0.055	0.09	< 0.5	11	71
BZX85B16	15.7	16.3	< 15	15	< 500	0.5	0.055	0.09	< 0.5	12	66
BZX85B18	17.6	18.4	< 20	15	< 500	0.5	0.06	0.09	< 0.5	13	62
BZX85B20	19.6	20.4	< 24	10	< 600	0.5	0.06	0.09	< 0.5	15	56
BZX85B22	21.6	22.4	< 25	10	< 600	0.5	0.06	0.095	< 0.5	16	52
BZX85B24	23.5	24.5	< 25	10	< 600	0.5	0.06	0.095	< 0.5	18	47
BZX85B27	26.5	27.5	< 30	8	< 750	0.25	0.06	0.095	< 0.5	20	41
BZX85B30	29.4	30.6	< 30	8	< 1000	0.25	0.06	0.095	< 0.5	22	36
BZX85B33	32.3	33.7	< 35	8	< 1000	0.25	0.06	0.095	< 0.5	24	33
BZX85B36	35.3	36.7	< 40	8	< 1000	0.25	0.06	0.095	< 0.5	27	30
BZX85B39	38.2	39.8	< 50	6	< 1000	0.25	0.06	0.095	< 0.5	30	28
BZX85B43	42.1	43.9	< 50	6	< 1000	0.25	0.06	0.095	< 0.5	33	26
BZX85B47	46.1	47.9	< 90	4	< 1500	0.25	0.06	0.095	< 0.5	36	23
BZX85B51	50	52	< 115	4	< 1500	0.25	0.06	0.095	< 0.5	39	21
BZX85B56	54.9	57.1	< 120	4	< 2000	0.25	0.06	0.095	< 0.5	43	19
BZX85B62	60.8	63.2	< 125	4	< 2000	0.25	0.06	0.095	< 0.5	47	16
BZX85B68	66.6	69.4	< 130	4	< 2000	0.25	0.055	0.095	< 0.5	51	15
BZX85B75	73.5	76.5	< 135	4	< 2000	0.25	0.055	0.095	< 0.5	56	14
BZX85B82	80.4	83.6	< 200	2.7	< 3000	0.25	0.055	0.095	< 0.5	62	12
BZX85B91	89.2	92.8	< 250	2.7	< 3000	0.25	0.055	0.095	< 0.5	68	10
BZX85B100	98	102	< 350	2.7	< 3000	0.25	0.055	0.095	< 0.5	75	9.4
BZX85B110	108	112	< 450	2.7	< 4000	0.25	0.055	0.095	< 0.5	82	8.6
BZX85B120	118	122	< 550	2	< 4500	0.25	0.055	0.095	< 0.5	91	7.8
BZX85B130	127	133	< 700	2	< 5000	0.25	0.055	0.095	< 0.5	100	7
BZX85B150	147	153	< 1000	2	< 6000	0.25	0.055	0.095	< 0.5	110	6.4

Partnumber	Zener Voltage Range <sup>1)</sup>		Dynamic Resistance				Temperature Coefficient of Zener Voltage		Reverse Leakage Current		Admissible Zener Current <sup>2)</sup>
	$V_Z @ I_{ZT}$		$r_{ZT}$ <sup>3)</sup>	@ $I_{ZT}$	$r_{ZK}$ <sup>3)</sup>	@ $I_{ZK}$	$\alpha_{VZ} @ I_Z = I_{ZT}$		@ $I_R$	@ $V_R$	$I_Z$
	V		$\Omega$	mA	$\Omega$	mA	%/°C		$\mu A$	V	mA
	min	max					min	max			
BZX85B160	157	163	< 1100	1.5	< 6500	0.25	0.055	0.095	< 0.5	120	5.8
BZX85B180	176	184	< 1200	1.5	< 7000	0.25	0.055	0.095	< 0.5	130	5.2
BZX85B200	196	204	< 1500	1.5	< 8000	0.25	0.055	0.095	< 0.5	150	4.7

<sup>1)</sup> Measured with pulses  $t_p = 5$  ms

<sup>2)</sup> Valid provided that leads are kept at ambient temperature at a distance of 10 mm from case

<sup>3)</sup> Measured with  $f = 1$  kHz

### Typical Characteristics ( $T_{amb} = 25^\circ C$ unless otherwise specified)

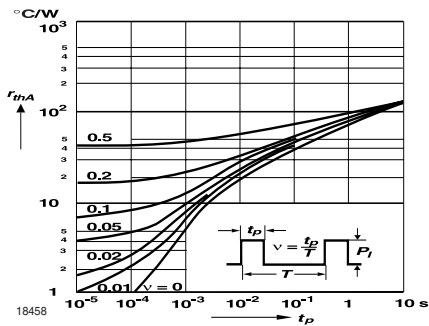

Figure 1. Pulse Thermal Resistance vs. Pulse Duration

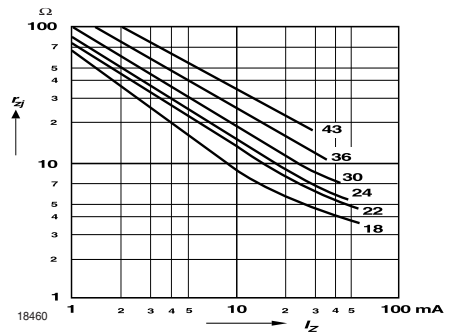

Figure 3. Dynamic Resistance vs. Zener Current

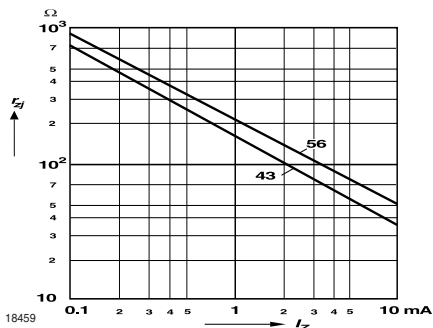

Figure 2. Dynamic Resistance vs. Zener Current

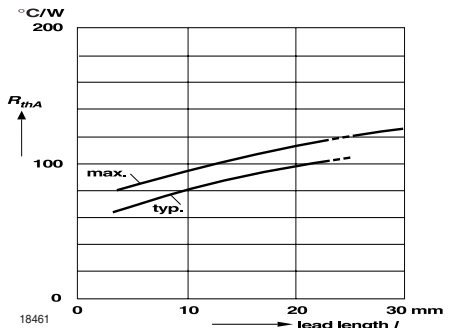

Figure 4. Thermal Resistance vs. Lead Length



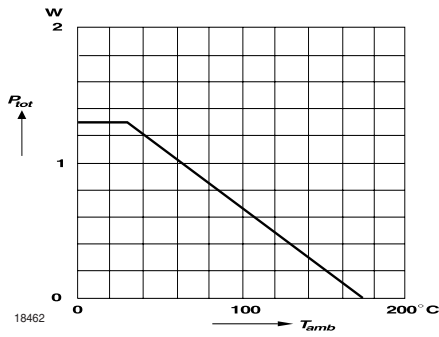

Figure 5. Admissible Power Dissipation vs. Ambient Temperature

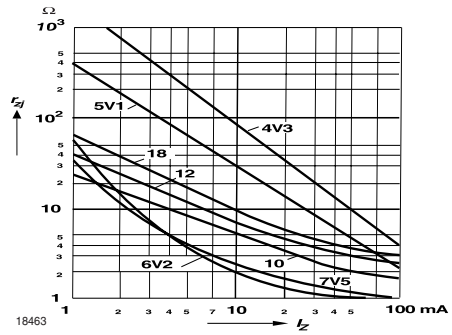

Figure 6. Dynamic Resistance vs. Zener Current

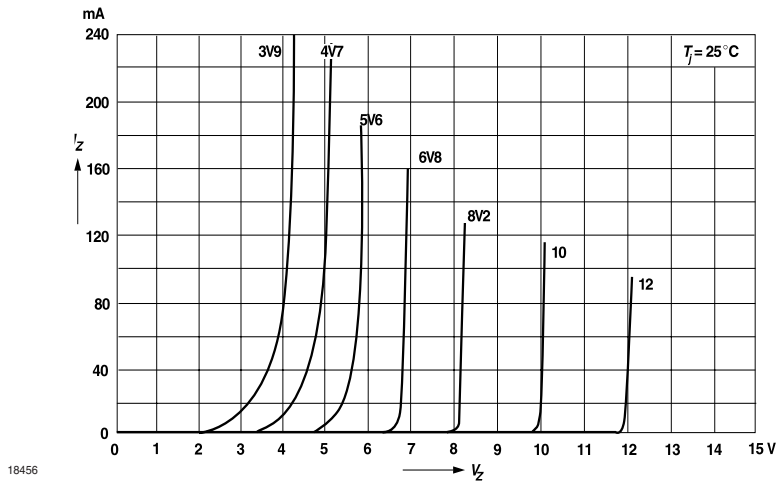

Figure 7. Breakdown Characteristics

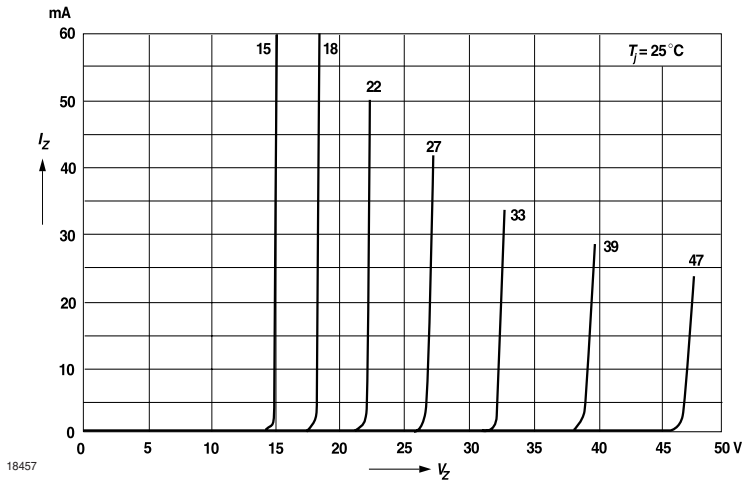

Figure 8. Breakdown Characteristics

**DO-41 Glass Package Dimension**  
see Package Section

# BZX85-Series

Vishay Semiconductors

---



## Small Signal Zener Diodes

### Features

- Silicon Planar Power Zener Diodes
- The Zener voltages are graded according to the international E 24 standard.
- Standard Zener voltage tolerance is  $\pm 5\%$ .  
Replace "C" with "B" for  $\pm 2\%$  tolerance.

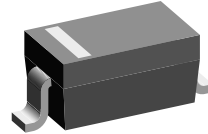

17431

### Mechanical Data

**Case:** SOD-323 Plastic case

**Weight:** approx. 5.0 mg

**Packaging Codes/Options:**

GS18 / 10 k per 13 " reel (8 mm tape), 10 k/box

GS08 / 3 k per 7 " reel (8 mm tape), 15 k/box

### Absolute Maximum Ratings

$T_{amb} = 25\text{ }^{\circ}\text{C}$ , unless otherwise specified

Parameter	Test condition	Symbol	Value	Unit
Power dissipation		$P_{tot}$	200 <sup>1)</sup>	mW

<sup>1)</sup> Device on fiberglass substrate

### Thermal Characteristics

$T_{amb} = 25\text{ }^{\circ}\text{C}$ , unless otherwise specified

Parameter	Test condition	Symbol	Value	Unit
Thermal resistance junction to ambient air		$R_{thJA}$	650 <sup>1)</sup>	$^{\circ}\text{C}/\text{W}$
Junction temperature		$T_j$	150	$^{\circ}\text{C}$
Storage temperature range		$T_S$	- 65 to + 150	$^{\circ}\text{C}$

<sup>1)</sup> Valid that electrodes are kept at ambient temperature

### Electrical Characteristics

Partnumber	Marking Code	Zener Voltage Range		Dynamic Resistance		Test Current	Temperature Coefficient of Zener Voltage		Test Current @I <sub>ZT2</sub>	Reverse Leakage Current		
		V <sub>Z</sub> @ I <sub>ZT</sub>		r <sub>zj</sub> @ I <sub>ZT1</sub>	r <sub>zj</sub> @ I <sub>ZT2</sub>		I <sub>ZT1</sub>	α <sub>VZ</sub> @ I <sub>ZT1</sub>		I <sub>R</sub>	V <sub>R</sub>	
		V		Ω	Ω		mA	10 <sup>-4</sup> /°C		μA	V	
		min	max	typ	typ		min	max				
BZX384C2V4	W1	2.2	2.6	70 (≤100)	275	5	-9	-4	1	50	1	
BZX384C2V7	W2	2.5	2.9	75 (≤100)	300 (≤600)	5	-9	-4	1	20	1	
BZX384C3	W3	2.8	3.2	80 (≤95)	325 (≤600)	5	-9	-3	1	10	1	
BZX384C3V3	W4	3.1	3.5	85 (≤95)	350 (≤600)	5	-8	-3	1	5	1	
BZX384C3V6	W5	3.4	3.8	85 (≤90)	375 (≤600)	5	-8	-3	1	5	1	
BZX384C3V9	W6	3.7	4.1	85 (≤90)	400 (≤600)	5	-7	-3	1	3	1	
BZX384C4V3	W7	4	4.6	80 (≤90)	410 (≤600)	5	-6	-1	1	3	1	
BZX384C4V7	W8	4.4	5	50 (≤80)	425 (≤500)	5	-5	2	1	3	2	
BZX384C5V1	W9	4.8	5.4	40 (≤60)	400 (≤480)	5	-3	4	1	2	2	
BZX384C5V6	WA	5.2	6	15 (≤40)	80 (≤400)	5	-2	6	1	1	2	
BZX384C6V2	WB	5.8	6.6	6.0 (≤10)	40 (≤150)	5	-1	7	1	3	4	
BZX384C6V8	WC	6.4	7.2	6.0 (≤15)	30 (≤80)	5	2	7	1	2	4	
BZX384C7V5	WD	7	7.9	6.0 (≤15)	30 (≤80)	5	3	7	1	1	5	
BZX384C8V2	WE	7.7	8.7	6.0 (≤15)	40 (≤80)	5	4	7	1	0.7	5	
BZX384C9V1	WF	8.5	9.6	6.0 (≤15)	40 (≤100)	5	5	8	1	0.5	6	
BZX384C10	WG	9.4	10.6	8.0 (≤20)	50 (≤150)	5	5	8	1	0.2	7	
BZX384C11	WH	10.4	11.6	10 (≤20)	50 (≤150)	5	5	9	1	0.1	8	
BZX384C12	WI	11.4	12.7	10 (≤25)	50 (≤150)	5	6	9	1	0.1	8	
BZX384C13	WK	12.4	14.1	10 (≤30)	50 (≤170)	5	7	9	1	0.1	8	
BZX384C15	WL	13.8	15.6	10 (≤30)	50 (≤200)	5	7	9	1	0.05	0.7V <sub>Znom.</sub>	
BZX384C16	WM	15.3	17.1	10 (≤40)	50 (≤200)	5	8	9.5	1	0.05	0.7V <sub>Znom.</sub>	
BZX384C18	WN	16.8	19.1	10 (≤45)	50 (≤225)	5	8	9.5	1	0.05	0.7V <sub>Znom.</sub>	
BZX384C20	WO	18.8	21.2	15 (≤55)	60 (≤225)	5	8	10	1	0.05	0.7V <sub>Znom.</sub>	
BZX384C22	WP	20.8	23.3	20 (≤55)	60 (≤250)	5	8	10	1	0.05	0.7V <sub>Znom.</sub>	
BZX384C24	WR	22.8	25.6	25 (≤70)	60 (≤250)	5	8	10	1	0.05	0.7V <sub>Znom.</sub>	
BZX384C27	WS	25.1	28.9	25 (≤80)	65 (≤300)	2	8	10	0.5	0.05	0.7V <sub>Znom.</sub>	
BZX384C30	WT	28	32	30 (≤80)	70 (≤300)	2	8	10	0.5	0.05	0.7V <sub>Znom.</sub>	
BZX384C33	WU	31	35	35 (≤80)	75 (≤325)	2	8	10	0.5	0.05	0.7V <sub>Znom.</sub>	
BZX384C36	WW	34	38	35 (≤90)	80 (≤350)	2	8	10	0.5	0.05	0.7V <sub>Znom.</sub>	
BZX384C39	WX	37	41	40 (≤130)	80 (≤350)	2	10	12	0.5	0.05	0.7V <sub>Znom.</sub>	
BZX384C43	WY	40	46	45 (≤150)	85 (≤375)	2	10	12	0.5	0.05	0.7V <sub>Znom.</sub>	
BZX384C47	WZ	44	50	50 (≤170)	85 (≤375)	2	10	12	0.5	0.05	0.7V <sub>Znom.</sub>	
BZX384C51	X1	48	54	60 (≤180)	85 (≤400)	2	10	12	0.5	0.05	0.7V <sub>Znom.</sub>	
BZX384C56	X2	52	60	70 (≤200)	100 (≤425)	2	9	11	0.5	0.05	0.7V <sub>Znom.</sub>	
BZX384C62	X3	58	66	80 (≤215)	100 (≤450)	2	9	12	0.5	0.05	0.7V <sub>Znom.</sub>	
BZX384C68	X4	64	72	90 (≤240)	150 (≤475)	2	10	12	0.5	0.05	0.7V <sub>Znom.</sub>	
BZX384C75	X5	70	79	95 (≤255)	170 (≤500)	2	10	12	0.5	0.05	0.7V <sub>Znom.</sub>	

(1) Measured with pulses t<sub>p</sub> = 5 ms



## Electrical Characteristics

Partnumber	Marking Code	Zener Voltage Range		Dynamic Resistance		Test Current	Temperature Coefficient of Zener Voltage		Test Current @ I <sub>ZT2</sub>	Reverse Leakage Current		
		V <sub>Z</sub> @ I <sub>ZT</sub>		r <sub>zj</sub> @ I <sub>ZT1</sub>	r <sub>zj</sub> @ I <sub>ZT2</sub>		I <sub>ZT1</sub>	α <sub>VZ</sub> @ I <sub>ZT1</sub>		I <sub>R</sub>	V <sub>R</sub>	
		V		Ω	Ω		mA	10 <sup>-4</sup> /°C		μA	V	
		min	max	typ	typ		min	max				
BZX384B2V4	W1	2.35	2.45	70 (≤100)	275	5	-9	-4	1	50	1	
BZX384B2V7	W2	2.65	2.75	75 (≤100)	300 (≤600)	5	-9	-4	1	20	1	
BZX384B3	W3	2.94	3.06	80 (≤95)	325 (≤600)	5	-9	-3	1	10	1	
BZX384B3V3	W4	3.23	3.37	85 (≤95)	350 (≤600)	5	-8	-3	1	5	1	
BZX384B3V6	W5	3.53	3.67	85 (≤90)	375 (≤600)	5	-8	-3	1	5	1	
BZX384B3V9	W6	3.82	3.98	85 (≤90)	400 (≤600)	5	-7	-3	1	3	1	
BZX384B4V3	W7	4.21	4.39	80 (≤90)	410 (≤600)	5	-6	-1	1	3	1	
BZX384B4V7	W8	4.61	4.79	50 (≤80)	425 (≤500)	5	-5	2	1	3	2	
BZX384B5V1	W9	5.00	5.20	40 (≤60)	400 (≤480)	5	-3	4	1	2	2	
BZX384B5V6	WA	5.49	5.71	15 (≤40)	80 (≤400)	5	-2	6	1	1	2	
BZX384B6V2	WB	6.08	6.32	6.0 (≤10)	40 (≤150)	5	-1	7	1	3	4	
BZX384B6V8	WC	6.66	6.94	6.0 (≤15)	30 (≤80)	5	2	7	1	2	4	
BZX384B7V5	WD	7.35	7.65	6.0 (≤15)	30 (≤80)	5	3	7	1	1	5	
BZX384B8V2	WE	8.04	8.36	6.0 (≤15)	40 (≤80)	5	4	7	1	0.7	5	
BZX384B9V1	WF	8.92	9.28	6.0 (≤15)	40 (≤100)	5	5	8	1	0.5	6	
BZX384B10	WG	9.80	10.2	8.0 (≤20)	50 (≤150)	5	5	8	1	0.2	7	
BZX384B11	WH	10.8	11.2	10 (≤20)	50 (≤150)	5	5	9	1	0.1	8	
BZX384B12	WI	11.8	12.2	10 (≤25)	50 (≤150)	5	6	9	1	0.1	8	
BZX384B13	WK	12.7	13.3	10 (≤30)	50 (≤170)	5	7	9	1	0.1	8	
BZX384B15	WL	14.7	15.3	10 (≤30)	50 (≤200)	5	7	9	1	0.05	0.7V <sub>Znom.</sub>	
BZX384B16	WM	15.7	16.3	10 (≤40)	50 (≤200)	5	8	9.5	1	0.05	0.7V <sub>Znom.</sub>	
BZX384B18	WN	17.6	18.4	10 (≤45)	50 (≤225)	5	8	9.5	1	0.05	0.7V <sub>Znom.</sub>	
BZX384B20	WO	19.6	20.4	15 (≤55)	60 (≤225)	5	8	10	1	0.05	0.7V <sub>Znom.</sub>	
BZX384B22	WP	21.6	22.4	20 (≤55)	60 (≤250)	5	8	10	1	0.05	0.7V <sub>Znom.</sub>	
BZX384B24	WR	23.5	24.5	25 (≤70)	60 (≤250)	5	8	10	1	0.05	0.7V <sub>Znom.</sub>	
BZX384B27	WS	26.5	27.5	25 (≤80)	65 (≤300)	2	8	10	0.5	0.05	0.7V <sub>Znom.</sub>	
BZX384B30	WT	29.4	30.6	30 (≤80)	70 (≤300)	2	8	10	0.5	0.05	0.7V <sub>Znom.</sub>	
BZX384B33	WU	32.3	33.7	35 (≤80)	75 (≤325)	2	8	10	0.5	0.05	0.7V <sub>Znom.</sub>	
BZX384B36	WW	35.3	36.7	35 (≤90)	80 (≤350)	2	8	10	0.5	0.05	0.7V <sub>Znom.</sub>	
BZX384B39	WX	38.2	39.8	40 (≤130)	80 (≤350)	2	10	12	0.5	0.05	0.7V <sub>Znom.</sub>	
BZX384B43	WY	42.1	43.9	45 (≤150)	85 (≤375)	2	10	12	0.5	0.05	0.7V <sub>Znom.</sub>	
BZX384B47	WZ	46.1	47.9	50 (≤170)	85 (≤375)	2	10	12	0.5	0.05	0.7V <sub>Znom.</sub>	
BZX384B51	X1	50.0	52.0	60 (≤180)	85 (≤400)	2	10	12	0.5	0.05	0.7V <sub>Znom.</sub>	
BZX384B56	X2	54.9	57.1	70 (≤200)	100 (≤425)	2	9	11	0.5	0.05	0.7V <sub>Znom.</sub>	
BZX384B62	X3	60.8	63.2	80 (≤215)	100 (≤450)	2	9	12	0.5	0.05	0.7V <sub>Znom.</sub>	
BZX384B68	X4	66.6	69.4	90 (≤240)	150 (≤475)	2	10	12	0.5	0.05	0.7V <sub>Znom.</sub>	
BZX384B75	X5	73.5	76.5	95 (≤255)	170 (≤500)	2	10	12	0.5	0.05	0.7V <sub>Znom.</sub>	

## Typical Characteristics ( $T_{amb} = 25^\circ\text{C}$ unless otherwise specified)

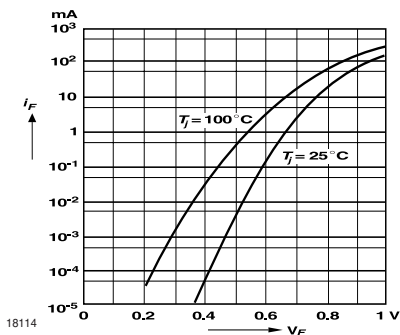

Figure 1. Forward characteristics

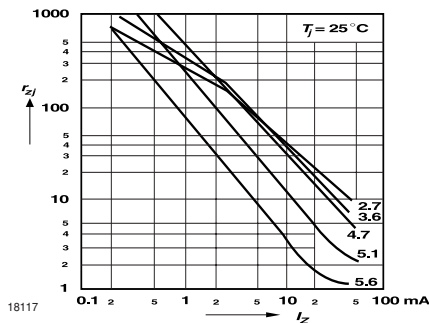

Figure 4. Dynamic Resistance vs. Zener Current

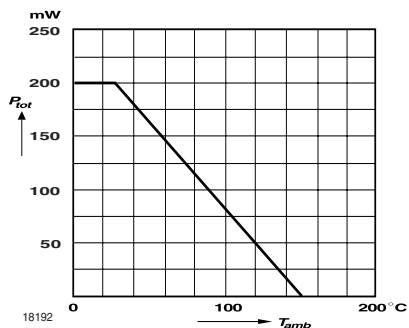

Figure 2. Admissible Power Dissipation vs. Ambient Temperature

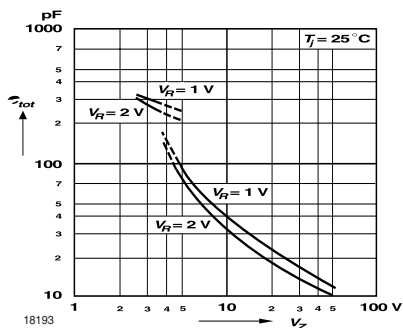

Figure 5. Capacitance vs. Zener Voltage

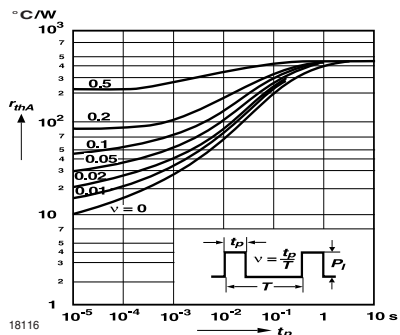

Figure 3. Pulse Thermal Resistance vs. Pulse Duration

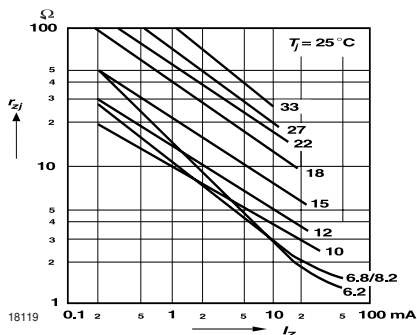

Figure 6. Dynamic Resistance vs. Zener Current

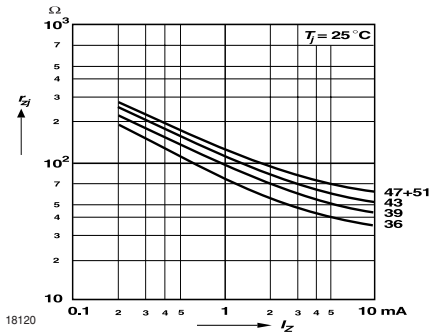

Figure 7. Dynamic Resistance vs. Zener Current

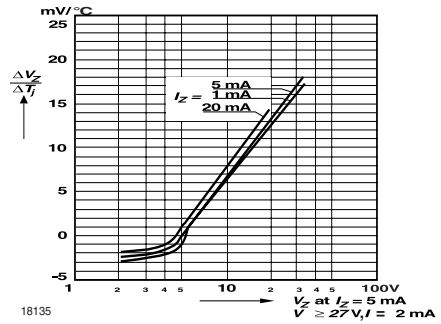

Figure 10. Temperature Dependence of Zener Voltage vs. Zener Voltage

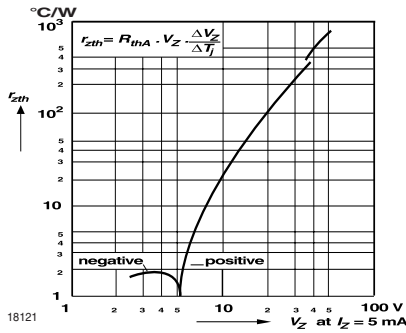

Figure 8. Thermal Differential Resistance vs. Zener Voltage

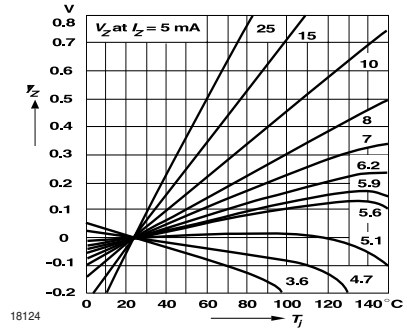

Figure 11. Change of Zener Voltage vs. Junction Temperature

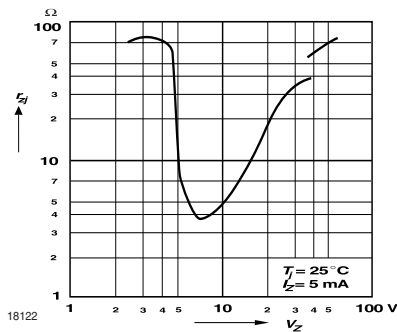

Figure 9. Dynamic Resistance vs. Zener Voltage

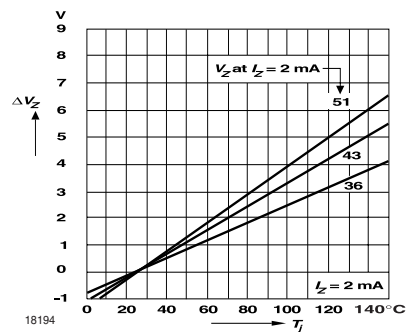

Figure 12. Change of Zener Voltage vs. Junction Temperature



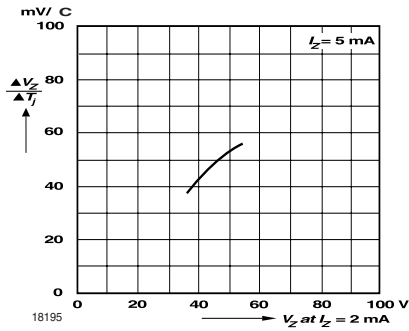

Figure 13. Temperature Dependence of Zener Voltage vs. Zener Voltage

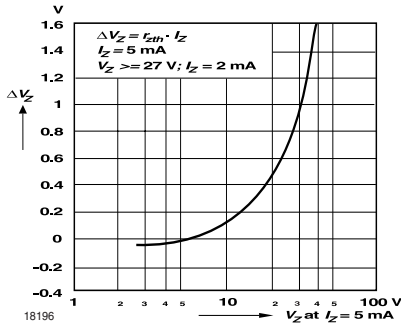

Figure 14. Change of Zener voltage from turn-on up to the point of thermal equilibrium vs. Zener voltage

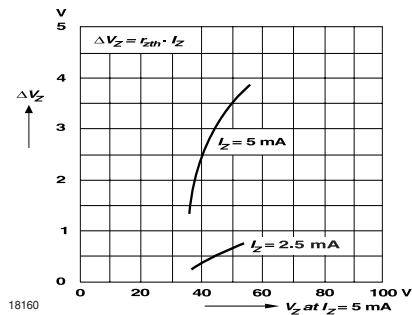

Figure 15. Change of Zener voltage from turn-on up to the point of thermal equilibrium vs. Zener voltage

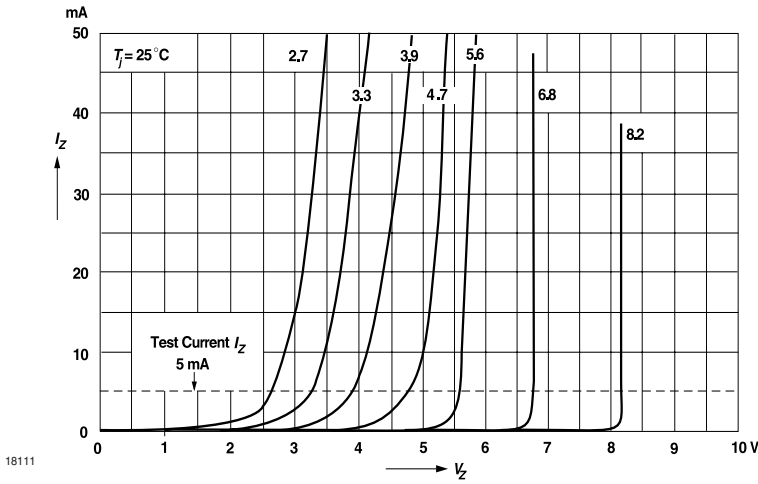

Figure 16. Breakdown Characteristics

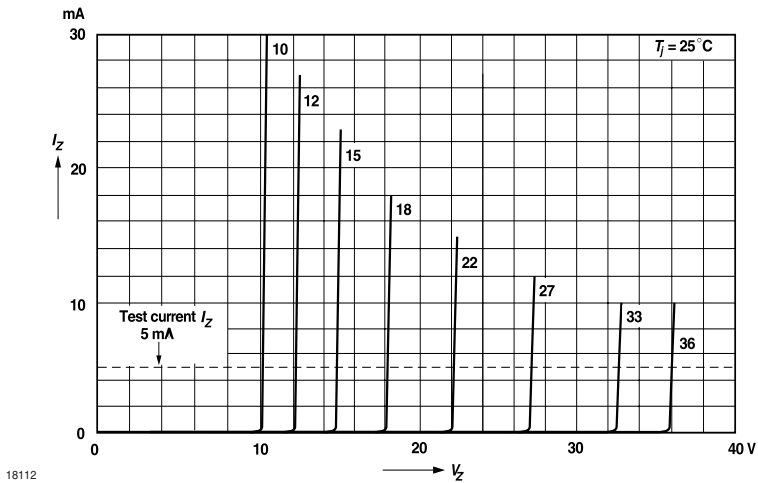

Figure 17. Breakdown Characteristics

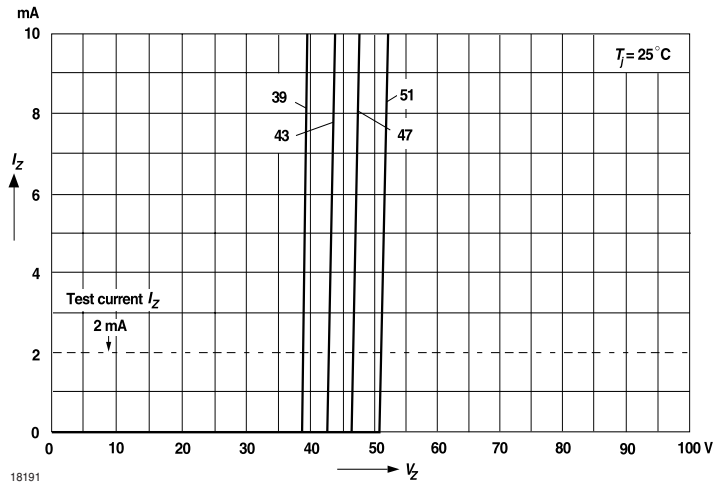

Figure 18. Breakdown Characteristics

**SOD-323 Package Dimension**  
see Package Section

## Small Signal Zener Diodes

### Features

- With the BZX584C..-02V series Vishay offers a Z-Diode in the tiny SOD-523 plastic package. Made for space sensitive applications the BZX584C..-02V series has a zener voltage tolerance of  $\pm 5\%$ . Other voltage tolerances are available on request.

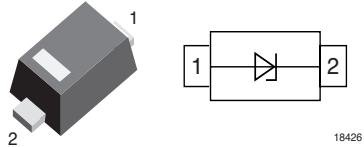

### Mechanical Data

**Case:** SOD-523 Plastic case

**Weight:** approx. 1.6 mg

**Packaging Codes/Options:**

GS08 / 3 k per 7" reel (8 mm tape), 15 k/box

### Absolute Maximum Ratings

$T_{amb} = 25\text{ }^{\circ}\text{C}$ , unless otherwise specified

Parameter	Test condition	Symbol	Value	Unit
Power dissipation		$P_{tot}$	200 <sup>1)</sup>	mW

<sup>1)</sup> Device on fiberglass substrate

### Thermal Characteristics

$T_{amb} = 25\text{ }^{\circ}\text{C}$ , unless otherwise specified

Parameter	Test condition	Symbol	Value	Unit
Thermal resistance junction to ambient air		$R_{thJA}$	680 <sup>1)</sup>	K/W
Thermal resistance junction to soldering point		$R_{thJS}$	100	K/W
Junction temperature		$T_j$	150	$^{\circ}\text{C}$
Storage temperature range		$T_S$	- 65 to + 150	$^{\circ}\text{C}$

<sup>1)</sup> Device on fiberglass substrate

# BZX584C-02V Series

Vishay Semiconductors



## Electrical Characteristics

Partnumber	Marking Code	Zener Voltage Range		Dynamic Resistance		Temp. Coefficient of Zener Voltage		Reverse Leakage Current	
		$V_Z @ 5 \text{ mA}$		$r_{zj} @ 5 \text{ mA}$	$r_{zj} @ 1 \text{ mA}$	$\alpha_{VZ} @ 5 \text{ mA}$		$I_R$	@ $V_R$
		V		$\Omega$		$10^{-4}/^{\circ}\text{C}$		$\mu\text{A}$	V
		min	max			min	max		
BZX584C2V4-02V	2	2.2	2.6	70 ( $\leq 100$ )	275 ( $\leq 600$ )	-9.0	-4.0	50	1
BZX584C2V7-02V	3	2.5	2.9	75 ( $\leq 100$ )	300 ( $\leq 600$ )	-9.0	-4.0	20	1
BZX584C3V0-02V	4	2.8	3.2	80 ( $\leq 95$ )	325 ( $\leq 600$ )	-9.0	-3.0	10	1
BZX584C3V3-02V	5	3.1	3.5	85 ( $\leq 95$ )	350 ( $\leq 600$ )	-8.0	-3.0	5	1
BZX584C3V6-02V	6	3.4	3.8	85 ( $\leq 90$ )	375 ( $\leq 600$ )	-8.0	-3.0	5	1
BZX584C3V9-02V	7	3.7	4.1	85 ( $\leq 90$ )	400 ( $\leq 600$ )	-7.0	-3.0	3	1
BZX584C4V3-02V	8	4	4.6	80 ( $\leq 90$ )	410 ( $\leq 600$ )	-6.0	-1.0	3	1
BZX584C4V7-02V	9	4.4	5	50 ( $\leq 80$ )	425 ( $\leq 500$ )	-5.0	+2.0	3	2
BZX584C5V1-02V	1	4.8	5.4	40 ( $\leq 60$ )	400 ( $\leq 480$ )	-3.0	+4.0	2	2
BZX584C5V6-02V	0	5.2	6	15 ( $\leq 40$ )	80 ( $\leq 400$ )	-2.0	+6.0	1	2
BZX584C6V2-02V	1 <sup>*)</sup>	5.8	6.6	6.0 ( $\leq 10$ )	40 ( $\leq 150$ )	-1.0	+7.0	3	4
BZX584C6V8-02V	2 <sup>*)</sup>	6.4	7.2	6.0 ( $\leq 15$ )	30 ( $\leq 80$ )	+2.0	+7.0	2	4
BZX584C7V5-02V	3 <sup>*)</sup>	7	7.9	6.0 ( $\leq 15$ )	30 ( $\leq 80$ )	+3.0	+7.0	1	5
BZX584C8V2-02V	T <sup>*)</sup>	7.7	8.7	6.0 ( $\leq 15$ )	40 ( $\leq 80$ )	+4.0	+7.0	0.7	5
BZX584C9V1-02V	S	8.5	9.6	6.0 ( $\leq 15$ )	40 ( $\leq 100$ )	+5.0	+8.0	0.5	6
BZX584C10-02V	R <sup>*)</sup>	9.4	10.6	8.0 ( $\leq 20$ )	50 ( $\leq 150$ )	+5.0	+8.0	0.2	7
BZX584C11-02V	P <sup>*)</sup>	10.4	11.6	10 ( $\leq 20$ )	50 ( $\leq 150$ )	+5.0	+9.0	0.1	8
BZX584C12-02V	7 <sup>*)</sup>	11.4	12.7	10 ( $\leq 25$ )	50 ( $\leq 150$ )	+6.0	+9.0	0.1	8
BZX584C13-02V	5 <sup>*)</sup>	12.4	14.1	10 ( $\leq 30$ )	50 ( $\leq 170$ )	+7.0	+9.0	0.1	8
BZX584C15-02V	4 <sup>*)</sup>	13.8	15.6	10 ( $\leq 30$ )	50 ( $\leq 200$ )	+7.0	+9.0	0.1	8

<sup>\*)</sup> Number turned by 180°

**SOD-523 Package Dimension**  
see Package Section

## Small Signal Zener Diodes, Dual

### Features

- This diode is also available in other case styles and configurations including: the dual diode common cathode configuration with type designation AZ23, the single diode SOT-23 case with the type designation BZX84C, and the single diode SOD-123 case with the type designation BZT52C.
- Dual Silicon Planar Zener Diodes, Common Cathode

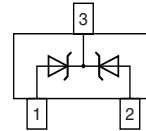
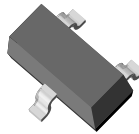

18110

- The Zener voltages are graded according to the international E 24 standard. Standard Zener voltage tolerance is  $\pm 5\%$ . Replace "C" with "B" for 2% tolerance.
- The parameters are valid for both diodes in one case.  $\Delta V_Z$  and  $\Delta r_{zj}$  of the two diodes in one case is  $\leq 5\%$

### Mechanical Data

**Case:** SOT-23 Plastic case

**Weight:** approx. 8.8 mg

**Packaging Codes/Options:**

GS18 / 10 k per 13 " reel, (8 mm tape), 10 k/box

GS08 / 3 k per 7 " reel, (8 mm tape), 15 k/box

### Absolute Maximum Ratings

$T_{amb} = 25\text{ }^\circ\text{C}$ , unless otherwise specified

Parameter	Test condition	Symbol	Value	Unit
Power dissipation		$P_{tot}$	300 <sup>1)</sup>	mW

<sup>1)</sup> Device on fiberglass substrate, see layout

### Thermal Characteristics

$T_{amb} = 25\text{ }^\circ\text{C}$ , unless otherwise specified

Parameter	Test condition	Symbol	Value	Unit
Thermal resistance junction to ambient air		$R_{thJA}$	420 <sup>1)</sup>	$^\circ\text{C/W}$
Junction temperature		$T_j$	150	$^\circ\text{C}$
Storage temperature range		$T_S$	- 65 to + 150	$^\circ\text{C}$

<sup>1)</sup> Device on fiberglass substrate, see layout

### Electrical Characteristics

Partnumber	Marking Code	Zener Voltage Range <sup>1)</sup>		Dynamic Resistance		Test Current	Temperature Coefficient of Zener Voltage		Reverse Voltage		
		$V_Z @ I_Z$		$r_{zj} @ I_Z = 5 \text{ mA}, f = 1 \text{ kHz},$	$r_{zj} @ I_Z = 1 \text{ mA}, f = 1 \text{ kHz},$		$I_Z$	$\alpha_{VZ} @ I_Z = 5 \text{ mA}$		$V_R @ I_R = 100 \text{ nA}$	
		V		$\Omega$			mA	$10^{-4}/^\circ\text{C}$		V	
		min	max				min	max			
DZ23C2V7	V1	2.5	2.9	75 (<83)	<500	5	-9	-4	-		
DZ23C3V0	V2	2.8	3.2	80 (<95)	<500	5	-9	-3	-		
DZ23C3V3	V3	3.1	3.5	80 (<95)	<500	5	-8	-3	-		
DZ23C3V6	V4	3.4	3.8	80 (<95)	<500	5	-8	-3	-		
DZ23C3V9	V5	3.7	4.1	80 (<95)	<500	5	-7	-3	-		
DZ23C4V3	V6	4	4.6	80 (<95)	<500	5	-6	-1	-		
DZ23C4V7	V7	4.4	5	70 (<78)	<500	5	-5	2	-		
DZ23C5V1	V8	4.8	5.4	30 (<60)	<480	5	-3	4	>0.8		
DZ23C5V6	V9	5.2	6	10 (<40)	<400	5	-2	6	>1		
DZ23C6V2	V10	5.8	6.6	4.8 (<10)	<200	5	-1	7	>2		
DZ23C6V8	V11	6.4	7.2	4.5 (<8)	<150	5	2	7	>3		
DZ23C7V5	V12	7	7.9	4 (<7)	<50	5	-3	7	>5		
DZ23C8V2	V13	7.7	8.7	4.5 (<7)	<50	5	4	7	>6		
DZ23C9V1	V14	8.5	9.6	4.8 (<10)	<50	5	5	8	>7		
DZ23C10	V15	9.4	10.6	5.2 (<15)	<70	5	5	8	>7.5		
DZ23C11	V16	10.4	11.6	6 (<20)	<70	5	5	9	>8.5		
DZ23C12	V17	11.4	12.7	7 (<20)	<90	5	6	9	>9		
DZ23C13	V18	12.4	14.1	9 (<25)	<110	5	7	9	>10		
DZ23C15	V19	13.8	15.6	11 (<30)	<110	5	7	9	>11		
DZ23C16	V20	15.3	17.1	13 (<40)	<170	5	8	9.5	>12		
DZ23C18	V21	16.8	19.1	18 (<50)	<170	5	8	9.5	>14		
DZ23C20	V22	18.8	21.2	20 (<50)	<220	5	8	10	>15		
DZ23C22	V23	20.8	23.3	25 (<55)	<220	5	8	10	>17		
DZ23C24	V24	22.8	25.6	28 (<80)	<220	5	8	10	>18		
DZ23C27	V25	25.1	28.9	30 (<80)	<250	5	8	10	>20		
DZ23C30	V26	28	32	35 (<80)	<250	5	8	10	>22.5		
DZ23C33	V27	31	35	40 (<80)	<250	5	8	10	>25		
DZ23C36	V28	34	38	40 (<90)	<250	5	8	10	>27		
DZ23C39	V29	37	41	50 (<90)	<300	5	10	12	>29		
DZ23C43	V30	40	46	60 (<100)	<700	5	10	12	>32		
DZ23C47	V31	44	50	70 (<100)	<750	5	10	12	>35		
DZ23C51	V32	48	54	70 (<100)	<750	5	10	12	>38		

<sup>1)</sup> Tested with pulses  $t_p = 5 \text{ ms}$

### Electrical Characteristics

Partnumber	Marking Code	Zener Voltage Range <sup>1)</sup>		Dynamic Resistance		Test Current	Temperature Coefficient of Zener Voltage		Reverse Voltage		
		$V_Z @ I_Z$		$r_{zj} @ I_Z = 5 \text{ mA}, f = 1 \text{ kHz},$	$r_{zj} @ I_Z = 1 \text{ mA}, f = 1 \text{ kHz},$		$I_Z$	$\alpha_{VZ} @ I_Z = 5 \text{ mA}$		$V_R @ I_R = 100 \text{ nA}$	
		V		$\Omega$			mA	$10^{-4}/^{\circ}\text{C}$		V	
		min	max				min	max			
DZ23B2V7	V1	2.65	2.75	75 (<83)	<500	5	-9	-4	-		
DZ23B3V0	V2	2.94	3.06	80 (<95)	<500	5	-9	-3	-		
DZ23B3V3	V3	3.23	3.37	80 (<95)	<500	5	-8	-3	-		
DZ23B3V6	V4	3.53	3.67	80 (<95)	<500	5	-8	-3	-		
DZ23B3V9	V5	3.82	3.98	80 (<95)	<500	5	-7	-3	-		
DZ23B4V3	V6	4.21	4.39	80 (<95)	<500	5	-6	-1	-		
DZ23B4V7	V7	4.61	4.79	70 (<78)	<500	5	-5	2	-		
DZ23B5V1	V8	5	5.2	30 (<60)	<480	5	-3	4	>0.8		
DZ23B5V6	V9	5.49	5.71	10 (<40)	<400	5	-2	6	>1		
DZ23B6V2	V10	6.08	6.32	4.8 (<10)	<200	5	-1	7	>2		
DZ23B6V8	V11	6.66	6.94	4.5 (<8)	<150	5	2	7	>3		
DZ23B7V5	V12	7.35	7.65	4 (<7)	<50	5	-3	7	>5		
DZ23B8V2	V13	8.04	8.36	4.5 (<7)	<50	5	4	7	>6		
DZ23B9V1	V14	8.92	9.28	4.8 (<10)	<50	5	5	8	>7		
DZ23B10	V15	9.8	10.2	5.2 (<15)	<70	5	5	8	>7.5		
DZ23B11	V16	10.8	11.2	6 (<20)	<70	5	5	9	>8.5		
DZ23B12	V17	11.8	12.2	7 (<20)	<90	5	6	9	>9		
DZ23B13	V18	12.7	13.3	9 (<25)	<110	5	7	9	>10		
DZ23B15	V19	14.7	15.3	11 (<30)	<110	5	7	9	>11		
DZ23B16	V20	15.7	16.3	13 (<40)	<170	5	8	0.5	>12		
DZ23B18	V21	17.6	18.4	18 (<50)	<170	5	8	0.5	>14		
DZ23B20	V22	19.6	20.4	20 (<50)	<220	5	8	10	>15		
DZ23B22	V23	21.6	22.4	25 (<55)	<220	5	8	10	>17		
DZ23B24	V24	23.5	24.5	28 (<80)	<220	5	8	10	>18		
DZ23B27	V25	26.5	27.5	30 (<80)	<250	5	8	10	>20		
DZ23B30	V26	29.4	30.6	35 (<80)	<250	5	8	10	>22.5		
DZ23B33	V27	32.3	33.7	40 (<80)	<250	5	8	10	>25		
DZ23B36	V28	35.3	36.7	40 (<90)	<250	5	8	10	>27		
DZ23B39	V29	38.2	39.8	50 (<90)	<300	5	10	12	>29		
DZ23B43	V30	42.1	43.9	60 (<100)	<700	5	10	12	>32		
DZ23B47	V31	46.1	47.9	70 (<100)	<750	5	10	12	>35		
DZ23B51	V32	50	52	70 (<100)	<750	5	10	12	>38		

<sup>1)</sup> Tested with pulses  $t_p = 5 \text{ ms}$



### Typical Characteristics ( $T_{amb} = 25\text{ }^{\circ}\text{C}$ unless otherwise specified)

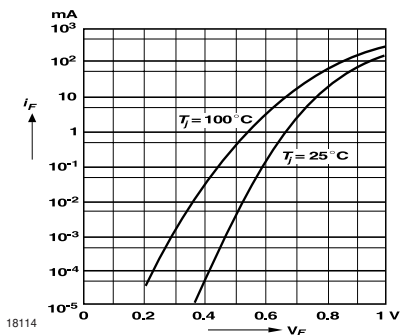

Figure 1. Forward characteristics

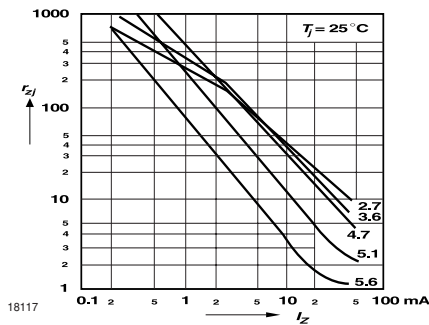

Figure 4. Dynamic Resistance vs. Zener Current

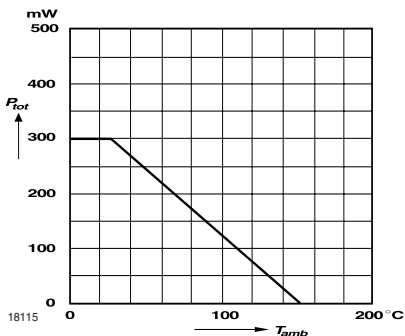

Figure 2. Admissible Power Dissipation vs. Ambient Temperature

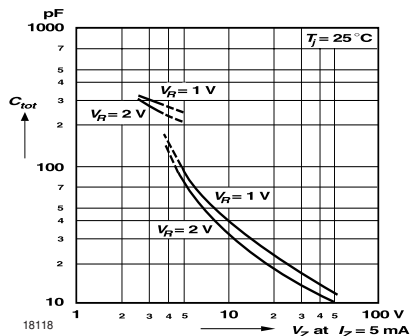

Figure 5. Capacitance vs. Zener Voltage

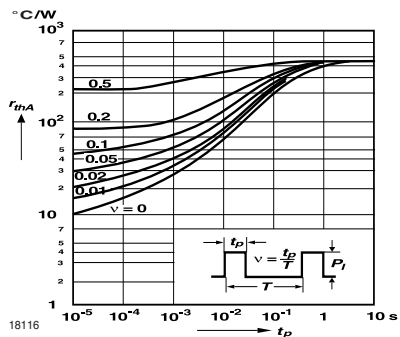

Figure 3. Pulse Thermal Resistance vs. Pulse Duration

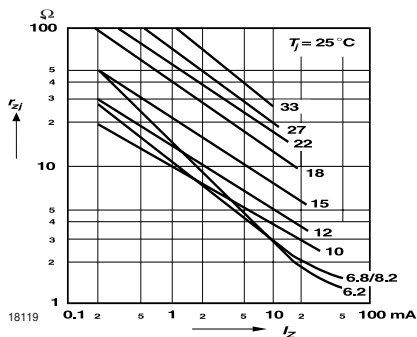

Figure 6. Dynamic Resistance vs. Zener Current

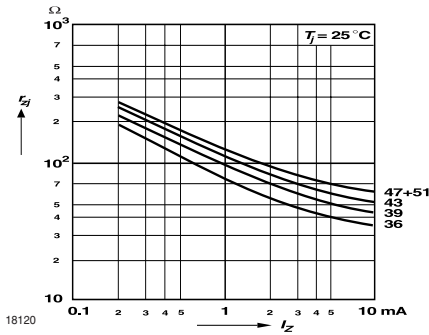

Figure 7. Dynamic Resistance vs. Zener Current

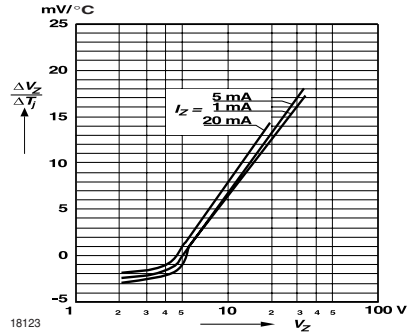

Figure 10. Temperature Dependence of Zener Voltage vs. Zener Voltage

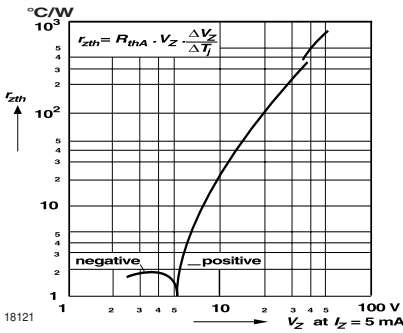

Figure 8. Thermal Differential Resistance vs. Zener Voltage

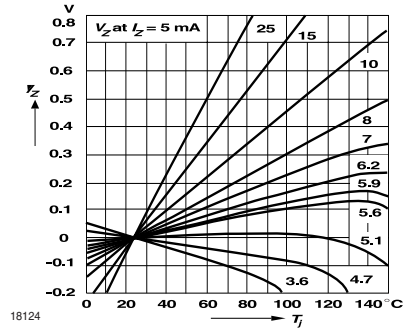

Figure 11. Change of Zener Voltage vs. Junction Temperature

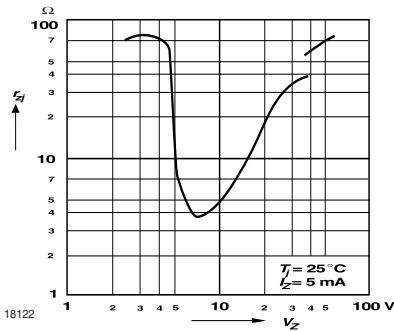

Figure 9. Dynamic Resistance vs. Zener Voltage

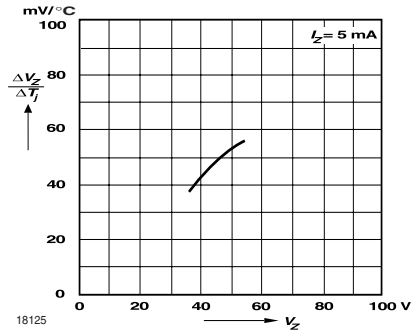

Figure 12. Temperature Dependence of Zener Voltage vs. Zener Voltage

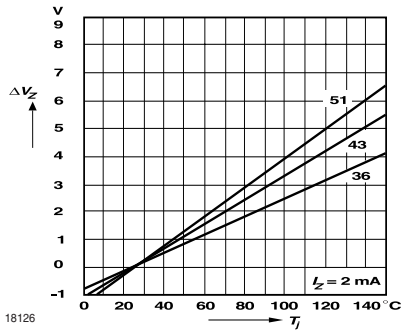

Figure 13. Change of Zener Voltage vs. Junction Temperature

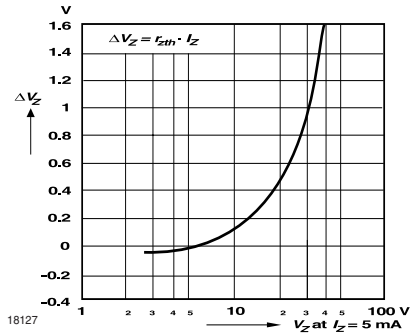

Figure 14. Change of Zener voltage from turn-on up to the point of thermal equilibrium vs. Zener voltage

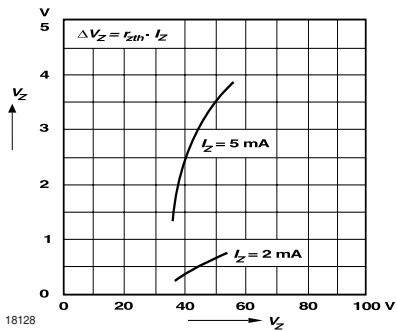

Figure 15. Change of Zener voltage from turn-on up to the point of thermal equilibrium vs. Zener voltage

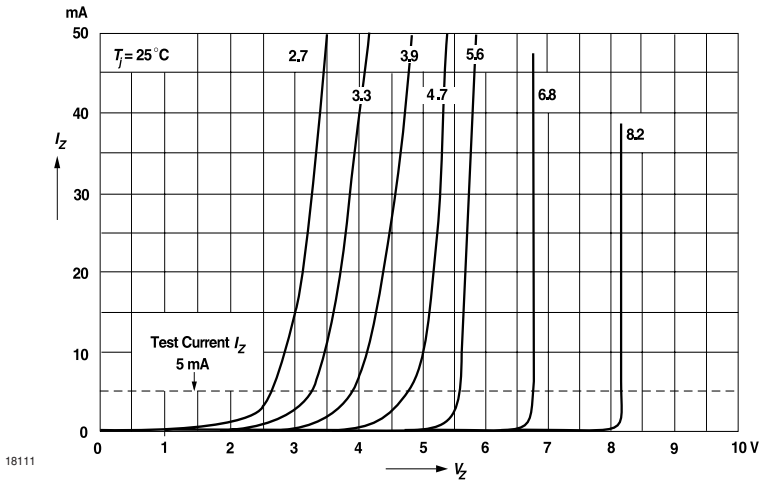

Figure 16. Breakdown Characteristics

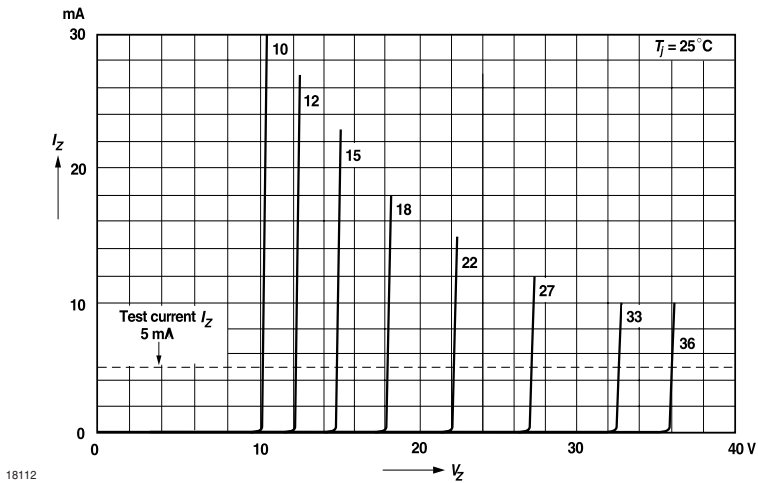
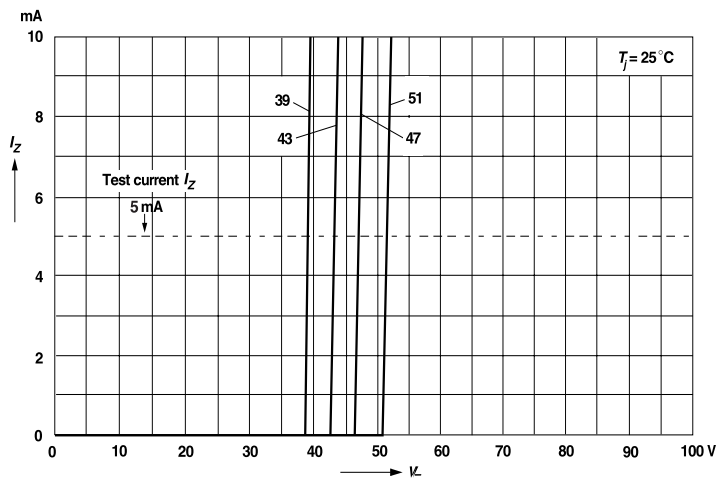

Figure 17. Breakdown Characteristics



18113

Figure 18. Breakdown Characteristics

**SOT-23 Package Dimension**  
see Package Section

## Small Signal Zener Diodes

### Features

- Silicon Planar Power Zener Diodes
- Low Zener impedance and low leakage current
- Popular in Asian designs
- Compact surface mount device
- Ideal for automated mounting

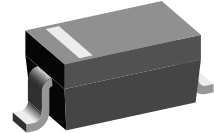

17431

### Mechanical Data

**Case:** SOD-323 Plastic case

**Weight:** approx. 5.0 mg

**Packaging Codes/Options:**

GS18/ 10 k per 13 " reel (8 mm tape), 10 k/box

GS08/ 3 k per 7 " reel (8 mm tape), 15 k/box

### Absolute Maximum Ratings

$T_{amb} = 25\text{ }^{\circ}\text{C}$ , unless otherwise specified

Parameter	Test condition	Symbol	Value	Unit
Power dissipation		$P_d$	200	mW

### Thermal Characteristics

$T_{amb} = 25\text{ }^{\circ}\text{C}$ , unless otherwise specified

Parameter	Test condition	Symbol	Value	Unit
Junction temperature		$T_j$	150	$^{\circ}\text{C}$
Storage temperature range		$T_{stg}$	- 55 to + 150	

### Electrical Characteristics

Partnumber	Marking Code	Zener Voltage Subdivision		Operating Resistance	Rising Operating Resistance	Test Current		Reverse Current	
		$V_Z @ I_{ZT}$	$V_Z @ I_{ZT1}$	$Z_Z @ I_{ZT1}$	$Z_{ZK} @ I_{ZT2}$	$I_{ZT1}$	$I_{ZT2}$	$I_R$	@ $V_R$
		V	V	$\Omega$		mA	mA	$\mu A$	V
		min	max	max	max				
GDZ2V0B	0 2	2.020	2.200	100	1000	5	0.5	120	0.5
GDZ2V2B	1 2	2.220	2.410	100	1000	5	0.5	120	0.7
GDZ2V4B	2 2	2.430	2.630	100	1000	5	0.5	120	1.0
GDZ2V7B	3 2	2.690	2.910	110	1000	5	0.5	100	1.0
GDZ3V0B	4 2	3.010	3.220	120	1000	5	0.5	50	1.0
GDZ3V3B	5 2	3.320	3.530	120	1000	5	0.5	20	1.0
GDZ3V6B	6 2	3.600	3.845	100	1000	5	1.0	10	1.0
GDZ3V9B	7 2	3.890	4.160	100	1000	5	1.0	5.0	1.0
GDZ4V3B	8 2	4.170	4.430	100	1000	5	1.0	5.0	1.0
GDZ4V7B	9 2	4.550	4.750	100	800	5	0.5	2.0	1.0
GDZ5V1B	T 1	4.980	5.200	80	500	5	0.5	2.0	1.0
GDZ5V6B	T 2	5.490	5.730	60	200	5	0.5	1.0	2.5
GDZ6V2B	T 3	6.060	6.330	60	100	5	0.5	1.0	3.0
GDZ6V8B	T 4	6.650	6.930	40	60	5	0.5	0.5	3.5
GDZ7V5B	T 5	7.280	7.600	30	60	5	0.5	0.5	4.0
GDZ8V2B	T 6	8.020	8.360	30	60	5	0.5	0.5	5.0
GDZ9V1B	T 7	8.850	9.230	30	60	5	0.5	0.5	6.0
GDZ10B	T 8	9.770	10.210	30	60	5	0.5	0.1	7.0
GDZ11B	T 9	10.760	11.220	30	60	5	0.5	0.1	8.0
GDZ12B	T A	11.740	12.240	30	80	5	0.5	0.1	9.0
GDZ13B	T B	12.910	13.490	37	80	5	0.5	0.1	10.0
GDZ15B	T C	14.340	14.980	42	80	5	0.5	0.1	11.0
GDZ16B	T D	15.850	16.510	50	80	5	0.5	0.1	12.0
GDZ18B	T E	17.560	18.350	65	80	5	0.5	0.1	13.0
GDZ20B	T H	19.520	20.390	85	100	5	0.5	0.1	15.0
GDZ22B	T K	21.540	22.470	100	100	5	0.5	0.1	17.0
GDZ24B	T L	23.720	24.780	120	120	5	0.5	0.1	19.0
GDZ27B	T M	26.190	27.530	150	150	5	0.5	0.1	21.0
GDZ30B	T N	29.190	30.690	200	200	5	0.5	0.1	23.0
GDZ33B	T P	32.150	33.790	250	250	5	0.5	0.1	25.0
GDZ36B	T T	35.070	36.870	300	300	5	0.5	0.1	27.0

Notes:

- (1) The Zener voltage  $V_Z$  is measured 40 ms after power is supplied.
- (2) The operating resistance ( $Z_Z$ ,  $Z_{ZK}$ ) are measured by superimposing a 1 KHz alternating current on the regulated current ( $I_Z$ ).

### SOD-323 Package Dimension see Package Section

## Small Signal Zener Diodes

### Features

- Silicon Planar Power Zener Diodes.
- Low profile surface-mount package.
- Low leakage current
- High temperature soldering:  
260 °C/10 sec. at terminals

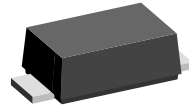

17249

### Mechanical Data

**Case:** JEDEC DO-219AB (SMF<sup>®</sup>) Plastic case

#### Packaging codes/options:

GS18 / 10 K per 13 " reel, (8 mm tape), 50 K/box

GS08 / 3 K per 7 " reel, (8 mm tape), 30 K/box

**Weight:** approx. 15 mg

### Absolute Maximum Ratings

T<sub>amb</sub> = 25 °C, unless otherwise specified

Parameter	Test condition	Symbol	Value	Unit
Zener current (see Table "Characteristics")			see page 2	
Power dissipation	T <sub>A</sub> = 25 °C	P <sub>tot</sub>	800 <sup>1)</sup>	mW

1) Mounted on epoxy glass PCB with 3 x 3 mm, Cu pads (≥ 40 μm thick)

### Thermal Characteristics

T<sub>amb</sub> = 25 °C, unless otherwise specified

Parameter	Test condition	Symbol	Value	Unit
Thermal resistance junction to ambient air <sup>1)</sup>		R <sub>thJA</sub>	180	K/W
Maximum junction temperature		T <sub>j</sub>	150	°C
Storage temperature range		T <sub>STG</sub>	- 55 to + 150	°C

1) Mounted on epoxy glass PCB with 3 x 3 mm, Cu pads (≥ 40 μm thick)



# GZF3V6C to GZF91C



Vishay Semiconductors

## Electrical Characteristics

Maximum  $V_F = 1.2$  V at  $I_F = 200$  mA

Partnumber	Marking Code	Zener Voltage Range <sup>1)</sup>		Differential Resistance		Temperature Coefficient		Test Current	Reverse Current at Reverse Voltage		
		$V_Z @ I_{ZT}$		$r_{dif} @ I_Z$		$\alpha_Z @ I_Z$			$I_{ZT}$	$I_R$	$V_R$
		V		$\Omega$		%/°C			mA	$\mu$ A	V
		min	max	typ	max	min	max		max		
GZF3V6C	W5	3.4	3.8	4	8	-0.14	-0.04	100	100	1	
GZF3V9C	W6	3.7	4.1	4	8	-0.14	-0.04	100	50	1	
GZF4V3C	W7	4	4.6	4	7	-0.12	-0.02	100	25	1	
GZF4V7C	W8	4.4	5	3	7	-0.1	0	100	10	1	
GZF5V1C	W9	4.8	5.4	3	6	-0.08	-0.2	100	5	1	
GZF5V6C	WA	5.2	6	2	4	-0.04	0.04	100	10	2	
GZF6V2C	WB	5.8	6.6	2	3	-0.01	0.06	100	5	2	
GZF6V8C	WC	6.4	7.2	1	3	0	0.07	100	10	3	
GZF7V5C	WD	7	7.9	1	2	0	0.07	100	50	3	
GZF8V2C	WE	7.7	8.7	1	2	0.03	0.08	100	10	3	
GZF9V1C	WF	8.5	9.6	2	4	0.03	0.08	50	10	5	
GZF10C	WG	9.4	10.6	2	4	0.05	0.09	50	7	7.5	
GZF11C	WH	10.4	11.6	4	7	0.05	0.1	50	4	8.2	
GZF12C	WI	11.4	12.7	4	7	0.05	0.1	50	3	9.1	
GZF13C	WK	12.4	14.1	5	10	0.05	0.1	50	2	10	
GZF15C	WL	13.8	15.6	5	10	0.05	0.1	50	1	11	
GZF16C	WM	15.3	17.1	6	15	0.06	0.11	25	1	12	
GZF18C	WN	16.8	19.1	6	15	0.06	0.11	25	1	13	
GZF20C	WO	18.8	21.2	6	15	0.06	0.11	25	1	15	
GZF22C	WP	20.8	23.3	6	15	0.06	0.11	25	1	16	
GZF24C	WR	22.8	25.6	7	15	0.06	0.11	25	1	18	
GZF27C	WS	25.1	28.9	7	15	0.06	0.11	25	1	20	
GZF30C	WT	28	32	8	15	0.06	0.11	25	1	22	
GZF33C	WU	31	35	8	15	0.06	0.11	25	1	24	
GZF36C	WW	34	38	21	40	0.06	0.11	10	1	27	
GZF39C	WX	37	41	21	40	0.06	0.11	10	1	30	
GZF43C	WY	40	46	24	45	0.07	0.12	10	1	33	
GZF47C	WZ	44	50	24	45	0.07	0.12	10	1	36	
GZF51C	X1	48	54	25	60	0.07	0.12	10	1	39	
GZF56C	X2	52	60	25	60	0.07	0.12	10	1	43	
GZF62C	X3	58	66	25	80	0.08	0.13	10	1	47	
GZF68C	X4	64	72	25	80	0.08	0.13	10	1	51	
GZF75C	X5	70	79	30	100	0.08	0.13	10	1	56	
GZF82C	X6	77	87	30	100	0.08	0.13	10	1	62	
GZF91C	X7	85	96	60	200	0.09	0.13	5	1	68	

<sup>1)</sup> Pulse test:  $t_p \leq 5$  ms

## Typical Characteristics ( $T_{amb} = 25\text{ }^{\circ}\text{C}$ unless otherwise specified)

**DO-219AB (SMF) Package Dimension**  
see Package Section

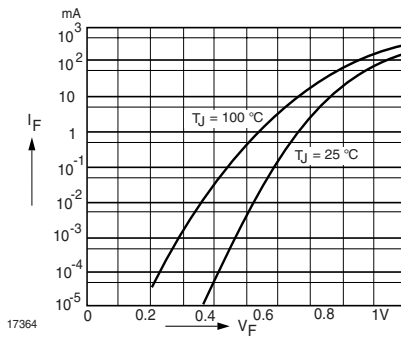

Figure 1. Forward characteristics

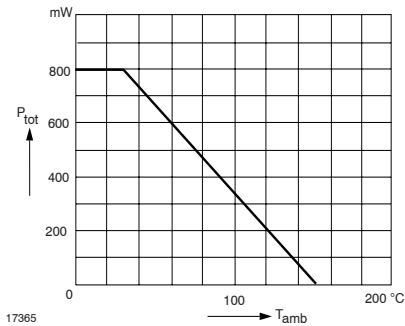

Figure 2. Admissible Power Dissipation vs. Ambient Temperature

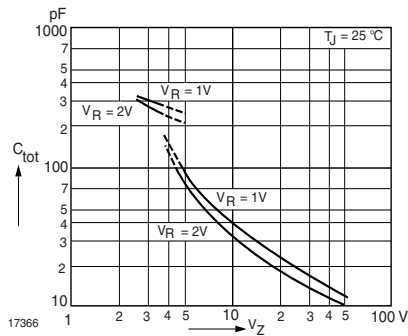

Figure 3. Capacitance vs. Zener Voltage

# GZF3V6C to GZF91C

Vishay Semiconductors

---



## Small Signal Zener Diodes

### Features

- Silicon Planar Low Noise Zener Diodes.
- 350 mW high quality voltage regulator designed for low leakage, low current and low noise applications
- 5 % Tolerance on  $V_Z$
- High temperature soldering guaranteed: 250 °C/10 seconds at terminals.

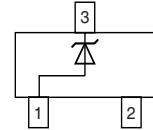
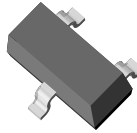

18078

### Mechanical Data

**Case:** SOT-23 Plastic case

**Weight:** approx. 8.8 mg

**Terminals:** Solderable per MIL-STD-750, method 2026

#### Packaging codes/options:

GS18 / 10 k per 13 " reel (8 mm tape), 10 k/box

GS08 / 3 k per 7 " reel (8 mm tape), 15 k/box

### Absolute Maximum Ratings

$T_{amb} = 25\text{ °C}$ , unless otherwise specified

Parameter	Test condition	Symbol	Value	Unit
Power dissipation		$P_{tot}$	350 <sup>1)</sup>	mW
Forward voltage, maximum	$I_F = 200\text{ mA}$	$V_F$	1.1	V
Forward voltage, typical	$I_F = 200\text{ mA}$	$V_F$	0.97	V

<sup>1)</sup> On FR - 5 board using recommended solder pad layout

### Thermal Characteristics

$T_{amb} = 25\text{ °C}$ , unless otherwise specified

Parameter	Test condition	Symbol	Value	Unit
Maximum junction temperature		$T_j$	150	°C
Storage temperature range		$T_S$	- 55 to + 150	°C
Thermal resistance junction to ambient air		$R_{thJA}$	420 <sup>1)</sup>	°C/W

<sup>1)</sup> On FR - 5 board using recommended solder pad layout

# MMBZ4617 to MMBZ4627



Vishay Semiconductors

## Electrical Characteristics

Partnumber	Marking Code	Zener <sup>1)</sup> Voltage	Test Current	Maximum Zener Impedance	Maximum Reverse Leakage Current		Maximum Zener Current	Maximum Noise Density
		$V_Z @ I_{ZT}$	$I_{ZT}$	$Z_{ZT} @ I_{ZT}$	$I_R$	$V_R$	$I_{ZM}$	$N_D @ I_{ZT} = 250 \mu A$
		V	$\mu A$	$\Omega$	$\mu A$	V	mA	$\mu V/\sqrt{Hz}$
MMBZ4617	G17	2.4	250	1400	2.0	1.0	95	1.0
MMBZ4618	G18	2.7	250	1500	1.0	1.0	90	1.0
MMBZ4619	G19	3.0	250	1600	0.8	1.0	85	1.0
MMBZ4620	G20	3.3	250	1650	7.5	1.5	80	1.0
MMBZ4621	G21	3.6	250	1700	7.5	2.0	75	1.0
MMBZ4622	G22	3.9	250	1650	5.0	2.0	70	1.0
MMBZ4623	G23	4.3	250	1600	4.0	2.0	65	1.0
MMBZ4624	G24	4.7	250	1550	10	3.0	60	1.0
MMBZ4625	G25	5.1	250	1500	10	3.0	55	2.0
MMBZ4626	G26	5.6	250	1400	10	4.0	50	4.0
MMBZ4627	G27	6.2	250	1200	10	5.0	45	5.0

Note: <sup>1)</sup>  $V_Z$  tested with 5 ms pulse

**SOT-23 Package Dimension**  
see Package Section

## Small Signal Zener Diodes

### Features

- Silicon Planar Zener Diodes.
- Standard Zener voltage tolerance is  $\pm 5\%$ . Other tolerances are available upon request.
- These diodes are also available in DO-35 case with the type designation 1N4681...1N4717 and SOD-123 case with the type designation MMSZ4681...MMSZ4717.

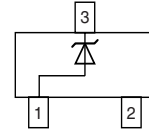
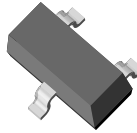

18078

### Mechanical Data

**Case:** SOT-23 Plastic case

**Weight:** approx. 8.8 mg

**Terminals:** Solderable per MIL-STD-750, method 2026

#### Packaging codes/options:

GS18 / 10 k per 13 " reel (8 mm tape), 10 k/box

GS08 / 3 k per 7 " reel (8 mm tape), 15 k/box

### Absolute Maximum Ratings

$T_{amb} = 25\text{ }^{\circ}\text{C}$ , unless otherwise specified

Parameter	Test condition	Symbol	Value	Unit
Zener current (see Table "Characteristics")				
Power dissipation	$T_A = 25\text{ }^{\circ}\text{C}$	$P_{tot}$	350 <sup>1)</sup>	mW

<sup>1)</sup> On FR - 5 board using recommended solder pad layout.

### Thermal Characteristics

$T_{amb} = 25\text{ }^{\circ}\text{C}$ , unless otherwise specified

Parameter	Test condition	Symbol	Value	Unit
Thermal resistance junction to ambient air		$R_{thJA}$	420 <sup>1)</sup>	$^{\circ}\text{C/W}$
Maximum junction temperature		$T_j$	150	$^{\circ}\text{C}$
Storage temperature range		$T_S$	- 55 to + 150	$^{\circ}\text{C}$

<sup>1)</sup> On FR - 5 board using recommended solder pad layout.

# MMBZ4681 to MMBZ4717



Vishay Semiconductors

## Electrical Characteristics

Maximum  $V_F = 0.9$  V, at  $I_F = 10$  mA

Partnumber	Marking Code	Zener Voltage <sup>1)</sup>			Max. Reverse Current	Reverse Voltage		
		$V_Z @ I_{ZT} = 50 \mu\text{A}$					$I_R$	$V_R$
		V					$\mu\text{A}$	V
		typ	min	max				
MMBZ4681	CF	2.4	2.28	2.52	2.0	1.0		
MMBZ4682	CH	2.7	2.57	2.84	1.0	1.0		
MMBZ4683	CJ	3.0	2.85	3.15	0.8	1.0		
MMBZ4684	CK	3.3	3.14	3.47	7.5	1.5		
MMBZ4685	CM	3.6	3.42	3.78	7.5	2.0		
MMBZ4686	CN	3.9	3.71	4.10	5.0	2.0		
MMBZ4687	CP	4.3	4.09	4.52	4.0	2.0		
MMBZ4688	CT	4.7	4.47	4.94	10.0	3.0		
MMBZ4689	CU	5.1	4.85	5.36	10.0	3.0		
MMBZ4690	CV	5.6	5.32	5.88	10.0	4.0		
MMBZ4691	CA	6.2	5.89	6.51	10.0	5.0		
MMBZ4692	CX	6.8	6.46	7.14	10.0	5.1		
MMBZ4693	CY	7.5	7.13	7.88	10.0	5.7		
MMBZ4694	CZ	8.2	7.79	8.61	1.0	6.2		
MMBZ4695	DC	8.7	8.27	9.14	1.0	6.6		
MMBZ4696	DD	9.1	8.65	9.56	1.0	6.9		
MMBZ4697	DE	10.0	9.50	10.5	1.0	7.6		
MMBZ4698	DF	11.0	10.50	11.6	0.05	8.4		
MMBZ4699	DH	12.0	11.40	12.6	0.05	9.1		
MMBZ4700	DJ	13.0	12.40	13.7	0.05	9.8		
MMBZ4701	DK	14.0	13.30	14.7	0.05	10.6		
MMBZ4702	DM	15.0	14.30	15.8	0.05	11.4		
MMBZ4703	DN	16.0	15.20	16.8	0.05	12.1		
MMBZ4704	DP	17.0	16.20	17.9	0.05	12.9		
MMBZ4705	DT	18.0	17.10	18.9	0.05	13.6		
MMBZ4706	DU	19.0	18.10	20.0	0.05	14.4		
MMBZ4707	DV	20.0	19.00	21.0	0.01	15.2		
MMBZ4708	DA	22.0	20.90	23.1	0.01	16.7		
MMBZ4709	DZ	24.0	22.80	25.2	0.01	18.2		
MMBZ4710	DY	25.0	23.80	26.3	0.01	19.0		
MMBZ4711	EA	27.0	25.70	28.4	0.01	20.4		
MMBZ4712	EC	28.0	26.60	29.4	0.01	21.2		
MMBZ4713	ED	30.0	28.50	31.5	0.01	22.8		
MMBZ4714	EE	33.0	31.40	34.7	0.01	25.0		
MMBZ4715	EF	36.0	34.20	37.8	0.01	27.3		
MMBZ4716	EH	39.0	37.10	41.0	0.01	29.6		
MMBZ4717	EJ	43.0	40.90	45.2	0.01	32.6		

<sup>1)</sup> Tested with pulse test current

**SOT-23 Package Dimension**  
see Package Section

## Small Signal Zener Diodes

### Features

- Silicon Planar Power Zener Diodes.
- Standard Zener voltage tolerance is  $\pm 5\%$  tolerance with a "B" suffix and  $\pm 2\%$  with suffix "C".
- High temperature soldering guaranteed: 250 °C/10 seconds at terminals.
- These diodes are also available in MiniMELF case with the type designation ZMM5225...ZMM5267, SOD-123 case with the type designation MMSZ5225... MMSZ5267.

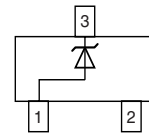
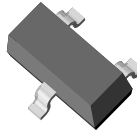

18078

### Mechanical Data

**Case:** SOT-23 Plastic case

**Weight:** approx. 8.8 mg

**Packaging Codes/Options:**

GS18 / 10 k per 13 " reel (8 mm tape), 10 k/box

GS08 / 3 k per 7 " reel (8 mm tape), 15 k/box

### Absolute Maximum Ratings

$T_{amb} = 25\text{ }^{\circ}\text{C}$ , unless otherwise specified

Parameter	Test condition	Symbol	Value	Unit
Zener current (see Table "Characteristics")				
Power dissipation	$T_A = 25\text{ }^{\circ}\text{C}$	$P_{tot}$	225 <sup>1)</sup>	mW
		$P_{tot}$	300 <sup>2)</sup>	mW

<sup>1)</sup> On FR - 5 board using recommended solder pad layout

<sup>2)</sup> On alumina substrate

### Thermal Characteristics

$T_{amb} = 25\text{ }^{\circ}\text{C}$ , unless otherwise specified

Parameter	Test condition	Symbol	Value	Unit
Thermal resistance junction to ambient air		$R_{thJA}$	556 <sup>1)</sup>	$^{\circ}\text{C/W}$
Maximum junction temperature		$T_j$	150	$^{\circ}\text{C}$
Storage temperature range		$T_S$	-65 to + 175	$^{\circ}\text{C}$

<sup>1)</sup> On FR - 5 board using recommended solder pad layout



# MMBZ5225 to MMBZ5267



Vishay Semiconductors

## Electrical Characteristics

T<sub>amb</sub> = 25 ° unless otherwise noted

Maximum V<sub>F</sub> = 0.9 V at I<sub>F</sub> = 10 mA

Partnumber	Marking Code	Nominal Zener Voltage	Test Current	Maximum Dynamic Impedance <sup>2)</sup>		Typical Temp. of Coefficient	Maximum Reverse Leakage Current	
				Z <sub>ZT</sub> @ I <sub>ZT</sub>	Z <sub>ZK</sub> @ I <sub>ZK</sub>		I <sub>R</sub>	V <sub>R</sub>
		V <sub>Z</sub> @ I <sub>ZT1</sub>	I <sub>ZT1</sub>	Z <sub>ZT</sub> @ I <sub>ZT</sub>	Z <sub>ZK</sub> @ I <sub>ZK</sub>	α <sub>VZ</sub>	I <sub>R</sub>	V <sub>R</sub>
		V	mA	Ω	Ω	%/°C	μA	V
MMBZ5225	18E	3	20	30	1600	-0.075	50	1
MMBZ5226	8A	3.3	20	28	1600	-0.07	25	1
MMBZ5227	8B	3.6	20	24	1700	-0.065	15	1
MMBZ5228	8C	3.9	20	23	1900	-0.06	10	1
MMBZ5229	8D	4.3	20	22	2000	-0.055	5	1
MMBZ5230	8E	4.7	20	19	1900	±0.030	5	2
MMBZ5231	8F	5.1	20	17	1600	±0.030	5	2
MMBZ5232	8G	5.6	20	11	1600	0.038	5	3
MMBZ5233	8H	6	20	7	1600	0.038	5	3.5
MMBZ5234	8J	6.2	20	7	1000	0.045	5	4
MMBZ5235	8K	6.8	20	5	750	0.05	3	5
MMBZ5236	8L	7.5	20	6	500	0.058	3	6
MMBZ5237	8M	8.2	20	8	500	0.062	3	6.5
MMBZ5238	8N	8.7	20	8	600	0.065	3	6.5
MMBZ5239	8P	9.1	20	10	600	0.068	3	7
MMBZ5240	8Q	10	20	17	600	0.075	3	8
MMBZ5241	8R	11	20	22	600	0.076	2	8.4
MMBZ5242	8S	12	20	30	600	0.077	1	9.1
MMBZ5243	8T	13	9.5	13	600	0.079	0.5	9.9
MMBZ5244	8U	14	9	15	600	0.082	0.1	10
MMBZ5245	8V	15	8.5	16	600	0.082	0.1	11
MMBZ5246	8W	16	7.8	17	600	0.083	0.1	12
MMBZ5247	8X	17	7.4	19	600	0.084	0.1	13
MMBZ5248	8Y	18	7	21	600	0.085	0.1	14
MMBZ5249	8Z	19	6.6	23	600	0.086	0.1	14
MMBZ5250	81A	20	6.2	25	600	0.086	0.1	15
MMBZ5251	81B	22	5.6	29	600	0.087	0.1	17
MMBZ5252	81C	24	5.2	33	600	0.087	0.1	18
MMBZ5253	81D	25	5	35	600	0.089	0.1	19
MMBZ5254	81E	27	4.6	41	600	0.090	0.1	21
MMBZ5255	81F	28	4.5	44	600	0.091	0.1	21
MMBZ5256	81G	30	4.2	49	600	0.091	0.1	23
MMBZ5257	81H	33	3.8	58	700	0.092	0.1	25
MMBZ5258	81J	36	3.4	70	700	0.093	0.1	27
MMBZ5259	81K	39	3.2	80	800	0.094	0.1	30
MMBZ5260	18F	43	3	93	900	0.095	0.1	33
MMBZ5261	81M	47	2.7	105	1000	0.095	0.1	36
MMBZ5262	81N	51	2.5	125	1100	0.096	0.1	39
MMBZ5263	81P	56	2.2	150	1300	0.096	0.1	43
MMBZ5264	81Q	60	2.1	170	1400	0.097	0.1	46
MMBZ5265	81R	62	2	185	1400	0.097	0.1	47
MMBZ5266	81S	68	1.8	230	1600	0.097	0.1	52
MMBZ5267	81T	75	1.7	270	1700	0.098	0.1	56

<sup>1)</sup>The Zener Impedance is derived from the 1 kHz AC voltage which results when an AC current having an RMS value equal to 10 % of

the Zener current ( $I_{ZT}$  or  $I_{ZK}$ ) is superimposed on  $I_{ZT}$  or  $I_{ZK}$ . Zener Impedance is measured at two points to insure a sharp knee on the breakdown curve and to eliminate unstable units.

- 2) Valid provided case is kept at ambient temperature.
- 3) Measured at thermal equilibrium.

## Typical Characteristics ( $T_{amb} = 25^\circ\text{C}$ unless otherwise specified)

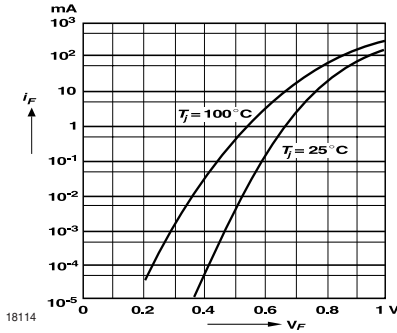

Figure 1. Forward characteristics

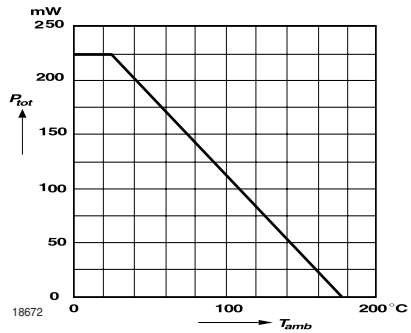

Figure 3. Admissible Power Dissipation vs. Ambient Temperature

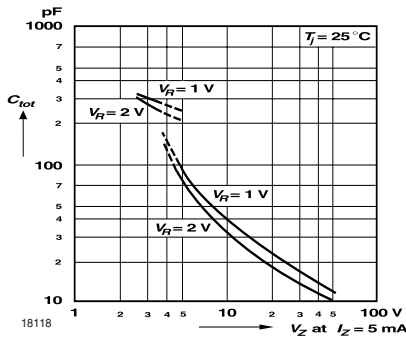

Figure 2. Capacitance vs. Zener Voltage

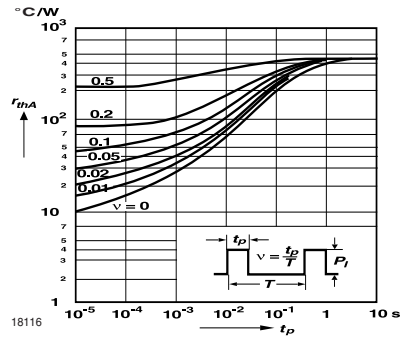

Figure 4. Pulse Thermal Resistance vs. Pulse Duration

**SOT-23 Package Dimension**  
see Package Section

# MMBZ5225 to MMBZ5267

Vishay Semiconductors

---



## Small Signal Zener Diodes, Dual

### Features

- Dual Silicon Planar Zener Diodes with Common Cathode or Common Anode configurations.
- Dual package provides for Bidirectional or separate unidirectional configurations.
- The dual configurations protect two separate lines with only one device.
- Peak Power: 40 W @ 1 ms (Bidirectional) .
- Ideal for ESD Protection.
- For bidirectional operation, circuit connected to pins 1 and 2. For unidirectional operation, circuit connected to pins 1 and 3 or pins 2 and 3.

### Mechanical Data

**Case:** SOT-23 Plastic case

**Weight:** approx. 8.8 mg

**Terminals:** Solderable per MIL-STD-750, method 2026

### Packaging Codes/Options:

GS18/ 10 k per 13 " reel (8 mm tape), 10 k/box

GS08/ 3 k per 7 " reel (8 mm tape), 15 k/box

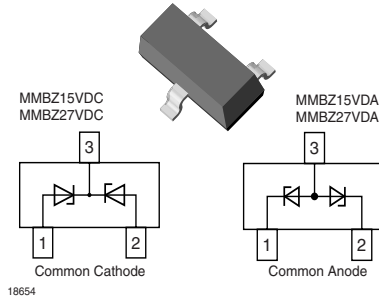

### Marking:

MMBZ15VDC = TC5

MMBZ27VDC = TC7

MMBZ15VDA = TA5

MMBZ27VDA = TA7

### Absolute Maximum Ratings

$T_{amb} = 25\text{ }^{\circ}\text{C}$ , unless otherwise specified

Parameter	Test condition	Symbol	Value	Unit
Peak power dissipation <sup>1)</sup>		$P_{PK}$	40 <sup>4)</sup>	W
Power dissipation on FR-5 Board <sup>2)</sup>	$T_{amb} = 25\text{ }^{\circ}\text{C}$	$P_{tot}$	225	mW
	Derate above 25 $^{\circ}\text{C}$		1.8	mW/ $^{\circ}\text{C}$
Power dissipation on Alumina Substrate <sup>3)</sup>	$T_{amb} = 25\text{ }^{\circ}\text{C}$	$P_{tot}$	300	mW
	Derate above 25 $^{\circ}\text{C}$		2.4	mW/ $^{\circ}\text{C}$

<sup>1)</sup> Nonrepetitive current pulse per Figure 2 and derate above  $T_{amb} = 25\text{ }^{\circ}\text{C}$  per Figure 3.

<sup>2)</sup> FR-5 = 1.0 x 0.75 x 0.62 in.

<sup>3)</sup> Alumina = 0.4 x 0.3 x 0.024 in., 99.5 % alumina.

<sup>4)</sup> The MMBZ6V8DC/A is rated at 24 V.

### Thermal Characteristics

$T_{amb} = 25\text{ }^{\circ}\text{C}$ , unless otherwise specified

Parameter	Test condition	Symbol	Value	Unit
Thermal resistance junction to ambient air		$R_{thJA}$	556	$^{\circ}\text{C}/\text{W}$
Operating and storage temperature range		$T_j, T_{stg}$	- 55 to + 150	$^{\circ}\text{C}$



## Electrical Characteristics

Partnumber	Breakdown Voltage <sup>1)</sup>		Test Current	Working Peak Reverse Voltage	Max. Reverse Leakage Current	Max. Reverse Surge Current	Max. Reverse Voltage (Clamping Voltage)	Max. Temperature Coefficient	Max. Forward Voltage	
	$V_{BR}$ at $I_T$								$V_F$	@ $I_F$
	V		mA	V	nA	A	V	mV/°C	V	mA
	min	max								
MMBZ15VDA	14.70	15.30	1.0	12.8	100	1.9	21.2	16	0.9	200
MMBZ27VDA	26.46	27.54	1.0	22.0	80	1.0	38.0	30	1.1	200
MMBZ15VDC	14.30	15.80	1.0	12.8	100	1.9	21.2	16	0.9	200
MMBZ27VDC	25.65	28.35	1.0	22.0	80	1.0	38.0	30	1.1	200

Note:

<sup>1)</sup>  $V_{BR}$  measured at pulse test current  $I_T$  at an ambient temperature of 25 °C

<sup>2)</sup> Surge current waveform per Figure 2 and derate per Figure 3

## Typical Characteristics ( $T_{amb} = 25\text{ °C}$ unless otherwise specified)

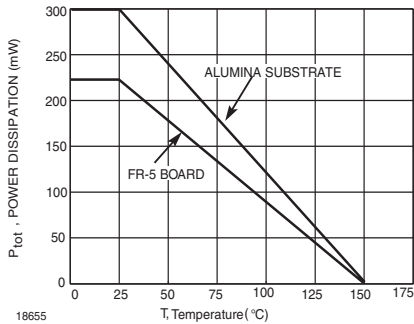

Figure 1. Steady State Power Derating Curve

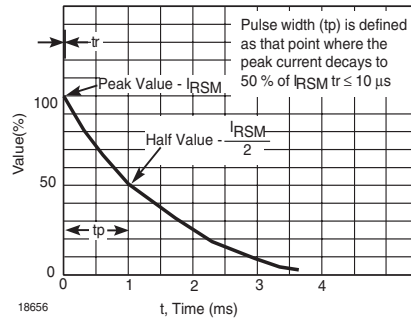

Figure 2. Pulse Waveform

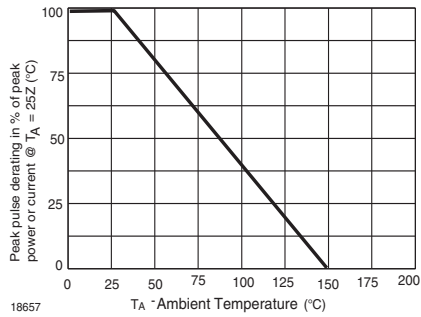

Figure 3. Pulse Derating Curve

**SOT-23 Package Dimension**  
see Package Section

# MMBZ...VDA and C Series

Vishay Semiconductors

---





## Small Signal Zener Diodes

### Features

- Silicon Planar Zener Diodes.
- Standard Zener voltage tolerance is  $\pm 5\%$ .
- High temperature soldering guaranteed:  
250 °C/10 seconds set terminals.
- These diodes are also available in DO-35 case with the type designation 1N4681...1N4717 and SOT-23 case with the type designation MMBZ4681... MMBZ4717.

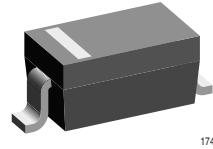

### Mechanical Data

**Case:** SOD-123 Plastic case

**Weight:** approx. 9.3 mg

**Packaging codes/options:**

GS18 / 10 k per 13 " reel (8 mm tape), 10 k/box

GS08 / 3 k per 7 " reel (8 mm tape), 15 k/box

### Absolute Maximum Ratings

$T_{amb} = 25\text{ °C}$ , unless otherwise specified

Parameter	Test condition	Symbol	Value	Unit
Zener current (see Table "Characteristics")				
Power dissipation	$T_L = 75\text{ °C}$	$P_{tot}$	500 <sup>1)</sup>	mW

<sup>1)</sup> On FR - 4 or FR - 5 board with minimum recommended solder pad layout.

### Thermal Characteristics

$T_{amb} = 25\text{ °C}$ , unless otherwise specified

Parameter	Test condition	Symbol	Value	Unit
Thermal resistance junction to ambient air		$R_{thJA}$	340 <sup>1)</sup>	°C/W
Maximum junction temperature		$T_j$	150	°C
Storage temperature range		$T_S$	- 55 to + 150	°C

<sup>1)</sup> On FR - 4 or FR - 5 board with minimum recommended solder pad layout.



# MMSZ4681 to MMSZ4717



Vishay Semiconductors

## Electrical Characteristics

$T_J = 25^\circ$  unless otherwise noted

Maximum  $V_F = 0.9$  V at  $I_F = 10$  mA

Partnumber	Marking Code	Zener Voltage <sup>1)</sup>			Max. Reverse Current $I_R$ $\mu$ A	Test Voltage $V_R$ V
		$V_Z @ I_{ZT} = 50 \mu$ A				
		typ	min	max		
MMSZ4681	CF	2.4	2.28	2.52	2	1
MMSZ4682	CH	2.7	2.57	2.84	1	1
MMSZ4683	CJ	3	2.85	3.15	0.8	1
MMSZ4684	CK	3.3	3.14	3.47	7.5	1.5
MMSZ4685	CM	3.6	3.42	3.78	7.5	2
MMSZ4686	CN	3.9	3.71	4.1	5	2
MMSZ4687	CP	4.3	4.09	4.52	4	2
MMSZ4688	CT	4.7	4.47	4.94	10	3
MMSZ4689	CU	5.1	4.85	5.36	10	3
MMSZ4690	CV	5.6	5.32	5.88	10	4
MMSZ4691	CA	6.2	5.89	6.51	10	5
MMSZ4692	CX	6.8	6.46	7.14	10	5.1
MMSZ4693	CY	7.5	7.13	7.88	10	5.7
MMSZ4694	CZ	8.2	7.79	8.61	1	6.2
MMSZ4695	DC	8.7	8.27	9.14	1	6.6
MMSZ4696	DD	9.1	8.65	9.56	1	6.9
MMSZ4697	DE	10	9.5	10.5	1	7.6
MMSZ4698	DF	11	10.5	11.6	0.05	8.4
MMSZ4699	DH	12	11.4	12.6	0.05	9.1
MMSZ4700	DJ	13	12.4	13.7	0.05	9.8
MMSZ4701	DK	14	13.3	14.7	0.05	10.6
MMSZ4702	DM	15	14.3	15.8	0.05	11.4
MMSZ4703	DN	16	15.2	16.8	0.05	12.1
MMSZ4704	DP	17	16.2	17.9	0.05	12.9
MMSZ4705	DT	18	17.1	18.9	0.05	13.6
MMSZ4706	DU	19	18.1	20	0.05	14.4
MMSZ4707	DV	20	19	21	0.01	15.2
MMSZ4708	DA	22	20.9	23.1	0.01	16.7
MMSZ4709	DZ	24	22.8	25.2	0.01	18.2
MMSZ4710	DY	25	23.8	26.3	0.01	19
MMSZ4711	EA	27	25.7	28.4	0.01	20.4
MMSZ4712	EC	28	26.6	29.4	0.01	21.2
MMSZ4713	ED	30	28.5	31.5	0.01	22.8
MMSZ4714	EE	33	31.4	34.7	0.01	25
MMSZ4715	EF	36	34.2	37.8	0.01	27.3
MMSZ4716	EH	39	37.1	41	0.01	29.6
MMSZ4717	EJ	43	40.9	45.2	0.01	32.6

<sup>1)</sup> Measured with device junction in thermal equilibrium

**SOD-123 Package Dimension**  
see Package Section



## Small Signal Zener Diodes

### Features

- Silicon Planar Power Zener Diodes.
- Standard Zener voltage tolerance is  $\pm 5\%$ , suffix "C" 2% tolerance
- These diodes are also available in MiniMELF case with the designation TZM5225 ...TZM5267, DO-35 case with type designation 1N5225 ... 1N5267 and SOT-23 case with the type designation MMBZ5225 ... MMBZ5267.

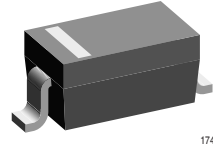

### Mechanical Data

**Case:** SOD-123 Plastic case

**Weight:** approx. 9.3 mg

**Packaging codes/options:**

GS18 / 10 k per 13 " reel (8 mm tape), 10 k/box

GS08 / 3 k per 7 " reel (8 mm tape), 15 k/box

### Absolute Maximum Ratings

$T_{amb} = 25\text{ }^{\circ}\text{C}$ , unless otherwise specified

Parameter	Test condition	Symbol	Value	Unit
Zener current (see Table "Characteristics")				
Power dissipation	$T_L = 75\text{ }^{\circ}\text{C}$	$P_{tot}$	500 <sup>1)</sup>	mW

<sup>1)</sup> On FR - 4 or FR - 5 board with minimum recommended solder pad layout.

### Thermal Characteristics

$T_{amb} = 25\text{ }^{\circ}\text{C}$ , unless otherwise specified

Parameter	Test condition	Symbol	Value	Unit
Thermal resistance junction to ambient air		$R_{thJA}$	340 <sup>1)</sup>	$^{\circ}\text{C}/\text{W}$
Maximum junction temperature		$T_j$	150	$^{\circ}\text{C}$
Storage temperature range		$T_S$	- 65 to + 175	$^{\circ}\text{C}$

<sup>1)</sup> On FR - 4 or FR - 5 board with minimum recommended solder pad layout.

# MMSZ5225 to MMSZ5267



Vishay Semiconductors

## Electrical Characteristics

T<sub>amb</sub> = 25 °C unless otherwise noted

Maximum V<sub>F</sub> = 0.9 V at I<sub>F</sub> = 10 mA

Partnumber	Marking Code	Nominal Zener Voltage <sup>2)</sup> V <sub>Z</sub> @ I <sub>ZT</sub>	Test Current I <sub>ZT</sub>	Maximum Dynamic Impedance <sup>1)</sup>		Typical Temperature of Coefficient α <sub>VZ</sub>	Maximum Reverse Leakage Current	
				Z <sub>ZT</sub> @ I <sub>ZT</sub>	Z <sub>ZK</sub> @ I <sub>ZK</sub> = 0.25 mA		I <sub>R</sub>	V <sub>R</sub>
				Ω	Ω		μA	V
		V	mA	Ω	Ω	%/°C	μA	V
MMSZ5225	C5	3.0	20	30	1600	-0.075	50	1.0
MMSZ5226	D1	3.3	20	28	1600	-0.070	25	1.0
MMSZ5227	D2	3.6	20	24	1700	-0.065	15	1.0
MMSZ5228	D3	3.9	20	23	1900	-0.060	10	1.0
MMSZ5229	D4	4.3	20	22	2000	-0.055	5.0	1.0
MMSZ5230	D5	4.7	20	19	1900	±0.030	5.0	2.0
MMSZ5231	E1	5.1	20	17	1600	±0.030	5.0	2.0
MMSZ5232	E2	5.6	20	11	1600	+0.038	5.0	3.0
MMSZ5233	E3	6.0	20	7	1600	+0.038	5.0	3.5
MMSZ5234	E4	6.2	20	7	1000	+0.045	5.0	4.0
MMSZ5235	E5	6.8	20	5	750	+0.050	3.0	5.0
MMSZ5236	F1	7.5	20	6	500	+0.058	3.0	6.0
MMSZ5237	F2	8.2	20	8	500	+0.062	3.0	6.5
MMSZ5238	F3	8.7	20	8	600	+0.065	3.0	6.5
MMSZ5239	F4	9.1	20	10	600	+0.068	3.0	7.0
MMSZ5240	F5	10	20	17	600	+0.075	3.0	8.0
MMSZ5241	H1	11	20	22	600	+0.076	2.0	8.4
MMSZ5242	H2	12	20	30	600	+0.077	1.0	9.1
MMSZ5243	H3	13	9.5	13	600	+0.079	0.5	9.9
MMSZ5244	H4	14	9.0	15	600	+0.082	0.1	10
MMSZ5245	H5	15	8.5	16	600	+0.082	0.1	11
MMSZ5246	J1	16	7.8	17	600	+0.083	0.1	12
MMSZ5247	J2	17	7.4	19	600	+0.084	0.1	13
MMSZ5248	J3	18	7.0	21	600	+0.085	0.1	14
MMSZ5249	J4	19	6.6	23	600	+0.086	0.1	14
MMSZ5250	J5	20	6.2	25	600	+0.086	0.1	15
MMSZ5251	K1	22	5.6	29	600	+0.087	0.1	17
MMSZ5252	K2	24	5.2	33	600	+0.087	0.1	18
MMSZ5253	K3	25	5.0	35	600	+0.089	0.1	19
MMSZ5254	K4	27	4.6	41	600	+0.090	0.1	21
MMSZ5255	K5	28	4.5	44	600	+0.091	0.1	21
MMSZ5256	M1	30	4.2	49	600	+0.091	0.1	23
MMSZ5257	M2	33	3.8	58	700	+0.092	0.1	25
MMSZ5258	M3	36	3.4	70	700	+0.093	0.1	27
MMSZ5259	M4	39	3.2	80	800	+0.094	0.1	30
MMSZ5260	M5	43	3.0	93	900	+0.095	0.1	33
MMSZ5261	N1	47	2.7	105	1000	+0.095	0.1	36
MMSZ5262	N2	51	2.5	125	1100	+0.096	0.1	39
MMSZ5263	N3	56	2.2	150	1300	+0.096	0.1	43
MMSZ5264	N4	60	2.1	170	1400	+0.097	0.1	46
MMSZ5265	N5	62	2.0	185	1400	+0.097	0.1	47
MMSZ5266	P1	68	1.8	230	1600	+0.097	0.1	52
MMSZ5267	P2	75	1.7	270	1700	+0.098	0.1	56

<sup>1)</sup> The Zener Impedance is derived from the 1 kHz AC voltage which results when an AC current having an RMS value equal to 10 % of



the Zener current ( $I_{ZT}$  or  $I_{ZK}$ ) is superimposed on  $I_{ZT}$  or  $I_{ZK}$ . Zener Impedance is measured at two points to insure a sharp knee on the breakdown curve and to eliminate unstable units.

<sup>2)</sup> Measured with device junction in thermal equilibrium.

**SOD-123 Package Dimension  
see Package Section**

# MMSZ5225 to MMSZ5267

Vishay Semiconductors

---





## Zener Diodes

### Features

- Plastic package has Underwriters Laboratory Flammability Classification 94 V-0
- For surface mounted applications
- Low Zener impedance
- Low regulation factor
- High temperature soldering guaranteed: 260 °C/10 seconds at terminals
- Standard voltage tolerance is 10 %, Suffix A  $\pm 5$  %.

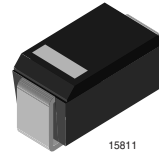

### Mechanical Data

**Case:** JEDEC DO-214AC molded plastic over passivated junction

**Terminals:** Solder plated, solderable per MIL-STD- 750, Method 2026

**Polarity:** Color band denotes positive end (cathode)

**Mounting Position:** Any

**Weight:** 0.002 ounce, 64 mg

### Packaging Codes - Options (Antistatic):

SML4728 - SML4737A:

11T - 1.8 k per 7" plastic reel (12mm tape), 36 k/carton

5AT - 7.5 k per 13" plastic reel (12mm tape), 75 k/carton

SML4738 - SML4764A:

61 - 1.8 k per 7" plastic reel (12mm tape), 36 k/carton

5A - 7.5 k per 13" plastic reel (12mm tape), 75 k/carton

### Absolute Maximum Ratings

$T_{amb} = 25$  °C, unless otherwise specified

Parameter	Test condition	Symbol	Value	Unit
Power dissipation	$T_L = 75$ °C	$P_{tot}$	1.0	W

### Thermal Characteristics

$T_{amb} = 25$  °C, unless otherwise specified

Parameter	Test condition	Symbol	Value	Unit
Maximum junction temperature		$T_j$	150	°C
Storage temperature range		$T_S$	- 65 to + 150	°C

### Electrical Characteristics

Partnumber	Device Marking Code	Nominal Zener Voltage	Test Current	Maximum Dynamic ImpedanceResistance			Maximum DC Reverse Leakage Current		Maximum Surge Current
		$V_Z^{(1)}$ @ $I_{ZT}$	$I_{ZT}$	$Z_{ZT}$ @ $I_{ZT}$	$Z_{ZK}$ @ $I_{ZK}$	$I_{ZK}$	$I_R$	$V_R$	$I_{RM}^{(2)}$
		V	mA	$\Omega$	$\Omega$	mA	$\mu A$	V	mApk
SML4728	3P3	3.3	76	10	400	1	100	1	1380
SML4729	3P6	3.6	69	10	400	1	100	1	1260
SML4730	3P9	3.9	64	9	400	1	50	1	1190
SML4731	4P3	4.3	58	9	400	1	10	1	1070
SML4732	4P7	4.7	53	8	500	1	10	1	970
SML4733	5P1	5.1	49	7	550	1	10	1	890
SML4734	5P6	5.6	45	5	600	1	10	2	810
SML4735	6P2	6.2	41	2	700	1	10	3	730
SML4736	6P8	6.8	37	3.5	700	1	10	4	660
SML4737	7P5	7.5	34	4	700	0.5	10	5	605
SML4738	8P2	8.2	31	4.5	700	0.5	10	6	550
SML4739	9P1	9.1	28	5	700	0.5	10	7	500
SML4740	10	10	25	7	700	0.25	10	7.6	454
SML4741	11	11	23	8	700	0.25	5	8.4	414
SML4742	12	12	21	9	700	0.25	5	9.1	380
SML4743	13	13	19	10	700	0.25	5	9.9	344
SML4744	15	15	17	14	700	0.25	5	11.4	305
SML4745	16	16	15.5	16	700	0.25	5	12.2	285
SML4746	18	18	14	20	750	0.25	5	13.7	250
SML4747	20	20	12.5	22	750	0.25	5	15.2	225
SML4748	22	22	11.5	23	750	0.25	5	16.7	205
SML4749	24	24	10.5	25	750	0.25	5	18.2	190
SML4750	27	27	9.5	35	750	0.25	5	20.6	170
SML4751	30	30	8.5	40	1000	0.25	5	22.8	150
SML4752	33	33	7.5	45	1000	0.25	5	25.1	135
SML4753	36	36	7	50	1000	0.25	5	27.4	125
SML4754	39	39	6.5	60	1000	0.25	5	29.7	115
SML4755	43	43	6	70	1500	0.25	5	32.7	110
SML4756	47	47	5.5	80	1500	0.25	5	35.8	95
SML4757	51	51	5	95	1500	0.25	5	38.8	90
SML4758	56	56	4.5	110	2000	0.25	5	42.6	80
SML4759	62	62	4	125	2000	0.25	5	47.1	70
SML4760	68	68	3.7	150	2000	0.25	5	51.7	65
SML4761	75	75	3.3	175	2000	0.25	5	56	60
SML4762	82	82	3	200	3000	0.25	5	62.2	55
SML4763	91	91	2.8	250	3000	0.25	5	69.2	50
SML4764	100	100	2.5	350	3000	0.25	5	76	45

<sup>1)</sup> Based on dc- measurement at thermal equilibrium

<sup>2)</sup> Surge current is a non-repetitive, 8.3 ms pulse width square wave or equivalent sine-wave superimposed on  $I_{ZT}$  per JEDEC Method

## Typical Characteristics ( $T_{amb} = 25^\circ\text{C}$ unless otherwise specified)

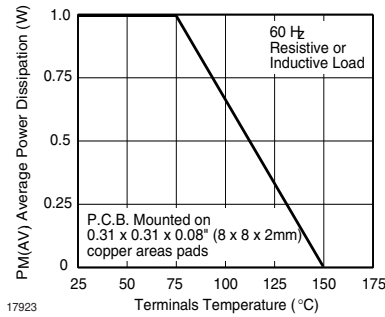

17923

Figure 1. Maximum Continuous Power Dissipation

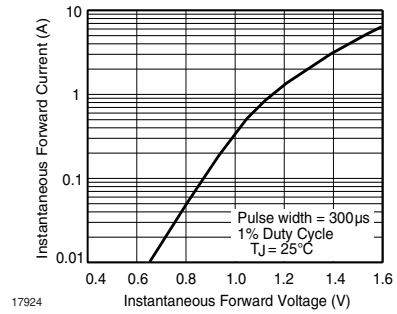

17924

Figure 4. Typical Instantaneous Forward Characteristics for SML4763

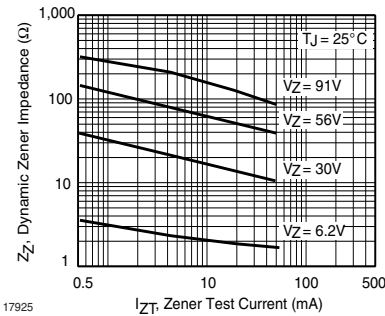

17925

Figure 2. Typical Zener Impedance

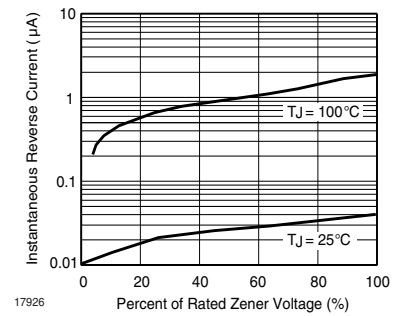

17926

Figure 5. Typical Reverse Characteristics

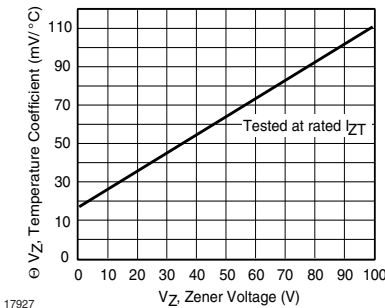

17927

Figure 3. Typical Temperature Coefficients

**DO-214AC Package Dimension  
see Package Section**



# SML4728 to SML4764A

Vishay Semiconductors

---



## Small Signal Zener Diodes

### Features

- Very sharp reverse characteristic
- Low reverse current level
- Very high stability
- Low noise
- High reliability

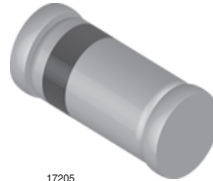

17205

### Applications

Voltage stabilization

### Mechanical Data

**Case:** MiniMELF Glass case (SOD-80)

**Weight:** approx. 31 mg

#### Packaging codes/ options:

GS18 / 10 k per 13" reel (8 mm tape), 10 k/box

GS08 / 2.5 k per 7" reel (8 mm tape), 12.5 k/box

### Absolute Maximum Ratings

$T_{amb} = 25\text{ }^{\circ}\text{C}$ , unless otherwise specified

Parameter	Test condition	Symbol	Value	Unit
Power dissipation	$R_{thJA} \leq 300\text{ K/W}$	$P_{tot}$	500	mW
Z-current		$I_Z$	$P_{tot}/V_Z$	mA
Junction temperature		$T_j$	175	$^{\circ}\text{C}$
Storage temperature range		$T_{stg}$	- 65... + 175	$^{\circ}\text{C}$

### Thermal Characteristics

$T_{amb} = 25\text{ }^{\circ}\text{C}$ , unless otherwise specified

Parameter	Test condition	Symbol	Value	Unit
Junction ambient	on PC board 50 mm x 50 mm x 1.6 mm	$R_{thJA}$	500	K/W

### Electrical Characteristics

$T_{amb} = 25\text{ }^{\circ}\text{C}$ , unless otherwise specified

Parameter	Test condition	Symbol	Min	Typ.	Max	Unit
Forward voltage	$I_F = 200\text{ mA}$	$V_F$			1.5	V



### Electrical Characteristics

Part-number-group	Part-number	Marking Code	Zener Voltage		Dynamic Resistance		Test Current		Reverse Leakage Current	
			$V_Z @ I_{ZT}$		$Z_Z @ I_{ZT}$	$Z_{ZK} @ I_{ZK}$	$I_{ZT}$	$I_{ZK}$	$I_R$	@ $V_R$
			V	V	$\Omega$	$\Omega$	mA	mA	$\mu A$	V
			min	max	max	max			max	
TLZ2V4	TLZ2V4A	2A4	2.33	2.52	100	2000	20	1	70	1
	TLZ2V4B	2B4	2.43	2.63	100	2000	20	1	70	1
TLZ2V7	TLZ2V7A	2A7	2.54	2.75	100	1000	20	1	50	1
	TLZ2V7B	2B7	2.69	2.91	100	1000	20	1	50	1
TLZ3V0	TLZ3V0A	3A0	2.85	3.07	80	1000	20	1	50	1
	TLZ3V0B	3B0	3.01	3.22	80	1000	20	1	10	1
TLZ3V3	TLZ3V3A	3A3	3.16	3.38	70	1000	20	1	10	1
	TLZ3V3B	3B3	3.32	3.53	70	1000	20	1	10	1
TLZ3V6	TLZ3V6A	3A6	3.455	3.695	60	1000	20	1	5	1
	TLZ3V6B	3B6	3.6	3.845	60	1000	20	1	5	1
TLZ3V9	TLZ3V9A	3A9	3.74	4.01	50	1000	20	1	3	1
	TLZ3V9B	3B9	3.89	4.16	50	1000	20	1	3	1
TLZ4V3	TLZ4V3A	4A3	4.04	4.29	40	1000	20	1	3	1
	TLZ4V3B	4B3	4.17	4.43	40	1000	20	1	3	1
	TLZ4V3C	4C3	4.3	4.57	40	1000	20	1	3	1
TLZ4V7	TLZ4V7A	4A7	4.44	4.68	25	900	20	1	10	2
	TLZ4V7B	4B7	4.55	4.8	25	900	20	1	6	2
	TLZ4V7C	4C7	4.68	4.93	25	900	20	1	3	2
TLZ5V1	TLZ5V1A	5A1	4.81	5.07	20	800	20	1	2	2
	TLZ5V1B	5B1	4.94	5.2	20	800	20	1	2	2
	TLZ5V1C	5C1	5.09	5.37	20	800	20	1	2	2
TLZ5V6	TLZ5V6A	5A6	5.28	5.55	13	500	20	1	1	2
	TLZ5V6B	5B6	5.45	5.73	13	500	20	1	1	2
	TLZ5V6C	5C6	5.61	5.91	13	500	20	1	1	2
TLZ6V2	TLZ6V2A	6A2	5.78	6.09	10	300	20	1	3	4
	TLZ6V2B	6B2	5.96	6.27	10	300	20	1	3	4
	TLZ6V2C	6C2	6.12	6.44	10	300	20	1	3	4
TLZ6V8	TLZ6V8A	6A8	6.29	6.63	8	150	20	0.5	2	4
	TLZ6V8B	6B8	6.49	6.83	8	150	20	0.5	2	4
	TLZ6V8C	6C8	6.66	7.01	8	150	20	0.5	2	4
TLZ7V5	TLZ7V5A	7A5	6.85	7.22	8	120	20	0.5	3	6.5
	TLZ7V5B	7B5	7.07	7.45	8	120	20	0.5	3	6.73
	TLZ7V5C	7C5	7.29	7.67	8	120	20	0.5	3	6.93
TLZ8V2	TLZ8V2A	8A2	7.53	7.92	8	120	20	0.5	7.5	7.15
	TLZ8V2B	8B2	7.78	8.19	8	120	20	0.5	7.5	7.39
	TLZ8V2C	8C2	8.03	8.45	8	120	20	0.5	7.5	7.63
TLZ9V1	TLZ9V1A	9A1	8.29	8.73	8	120	20	0.5	0.04	7.88
	TLZ9V1B	9B1	8.57	9.01	8	120	20	0.5	0.04	8.14
	TLZ9V1C	9C1	8.83	9.3	8	120	20	0.5	0.04	8.39
TLZ10	TLZ10A	10A	9.12	9.59	8	120	20	0.5	0.04	8.66
	TLZ10B	10B	9.41	9.9	8	120	20	0.5	0.04	8.94
	TLZ10C	10C	9.7	10.2	8	120	20	0.5	0.04	9.22
	TLZ10D	10D	9.94	10.44	8	120	20	0.5	0.04	9.44



Part-number-group	Part-number	Marking Code	Zener Voltage		Dynamic Resistance		Test Current		Reverse Leakage Current	
			$V_Z @ I_{ZT}$		$Z_Z @ I_{ZT}$	$Z_{ZK} @ I_{ZK}$	$I_{ZT}$	$I_{ZK}$	$I_R$	@ $V_R$
			V	V	$\Omega$	$\Omega$	mA	mA	$\mu A$	V
TLZ11	TLZ11A	11A	10.18	10.71	10	120	10	0.5	0.04	9.67
	TLZ11B	11B	10.5	11.05	10	120	10	0.5	0.04	9.98
	TLZ11C	11C	10.82	11.38	10	120	10	0.5	0.04	10.28
TLZ12	TLZ12A	12A	11.13	11.71	12	110	10	0.5	0.04	10.6
	TLZ12B	12B	11.44	12.03	12	110	10	0.5	0.04	10.9
	TLZ12C	12C	11.74	12.35	12	110	10	0.5	0.04	11.2
TLZ13	TLZ13A	13A	12.11	12.75	14	110	10	0.5	0.04	11.5
	TLZ13B	13B	12.55	13.21	14	110	10	0.5	0.04	11.9
	TLZ13C	13C	12.99	13.66	14	110	10	0.5	0.04	12.3
TLZ15	TLZ15A	15A	13.44	14.13	16	110	10	0.5	0.04	12.8
	TLZ15B	15B	13.89	14.62	16	110	10	0.5	0.04	13.2
	TLZ15C	15C	14.35	15.09	16	110	10	0.5	0.04	13.6
TLZ16	TLZ16A	16A	14.8	15.57	18	150	10	0.5	0.04	14.1
	TLZ16B	16B	15.25	16.04	18	150	10	0.5	0.04	14.5
	TLZ16C	16C	15.69	16.51	18	150	10	0.5	0.04	14.9
TLZ18	TLZ18A	18A	16.22	17.06	23	150	10	0.5	0.04	15.4
	TLZ18B	18B	16.82	17.7	23	150	10	0.5	0.04	16
	TLZ18C	18C	17.42	18.33	23	150	10	0.5	0.04	16.5
TLZ20	TLZ20A	20A	18.02	18.96	28	200	10	0.5	0.04	17.1
	TLZ20B	20B	18.63	19.59	28	200	10	0.5	0.04	17.7
	TLZ20C	20C	19.23	20.22	28	200	10	0.5	0.04	18.3
	TLZ20D	20D	19.72	20.72	28	200	10	0.5	0.04	18.7
TLZ22	TLZ22A	22A	20.15	21.2	30	200	5	0.5	0.04	19.1
	TLZ22B	22B	20.64	21.71	30	200	5	0.5	0.04	19.6
	TLZ22C	22C	21.08	22.17	30	200	5	0.5	0.04	20
	TLZ22D	22D	21.52	22.63	30	200	5	0.5	0.04	20.4
TLZ24	TLZ24A	24A	22.05	23.18	35	200	5	0.5	0.04	20.9
	TLZ24B	24B	22.61	23.77	35	200	5	0.5	0.04	21.5
	TLZ24C	24C	23.12	24.31	35	200	5	0.5	0.04	22
	TLZ24D	24D	23.63	24.85	35	200	5	0.5	0.04	22.4
TLZ27	TLZ27A	27A	24.26	25.52	45	250	5	0.5	0.04	23
	TLZ27B	27B	24.97	26.26	45	250	5	0.5	0.04	23.7
	TLZ27C	27C	25.63	26.95	45	250	5	0.5	0.04	24.3
	TLZ27D	27D	26.29	27.64	45	250	5	0.5	0.04	25
TLZ30	TLZ30A	30A	26.99	28.39	55	250	5	0.5	0.04	25.6
	TLZ30B	30B	27.7	29.13	55	250	5	0.5	0.04	26.3
	TLZ30C	30C	28.36	29.82	55	250	5	0.5	0.04	26.9
	TLZ30D	30D	29.02	30.51	55	250	5	0.5	0.04	27.6
TLZ33	TLZ33A	33A	29.68	31.22	65	250	5	0.5	0.04	28.2
	TLZ33B	33B	30.32	31.88	65	250	5	0.5	0.04	28.8
	TLZ33C	33C	30.9	32.5	65	250	5	0.5	0.04	29.4
	TLZ33D	33D	31.49	33.11	65	250	5	0.5	0.04	29.9
TLZ36	TLZ36A	36A	32.14	33.79	75	250	5	0.5	0.04	30.5
	TLZ36B	36B	32.79	34.49	75	250	5	0.5	0.04	31.2
	TLZ36C	36C	33.4	35.13	75	250	5	0.5	0.04	31.7
	TLZ36D	36D	34.01	35.77	75	250	5	0.5	0.04	32.3



Part-number-group	Part-number	Marking Code	Zener Voltage		Dynamic Resistance		Test Current		Reverse Leakage Current	
			$V_Z @ I_{ZT}$		$Z_Z @ I_{ZT}$	$Z_{ZK} @ I_{ZK}$	$I_{ZT}$	$I_{ZK}$	$I_R$	@ $V_R$
			V	V	$\Omega$	$\Omega$	mA	mA	$\mu A$	V
			min	max	max	max			max	
TLZ39	TLZ39A	39A	34.68	36.47	85	250	5	0.5	0.04	32.9
	TLZ39B	39B	35.36	37.19	85	250	5	0.5	0.04	33.6
	TLZ39C	39C	36	37.85	85	250	5	0.5	0.04	34.2
	TLZ39D	39D	36.63	38.52	85	250	5	0.5	0.04	34.8
	TLZ39E	39E	37.36	39.29	85	250	5	0.5	0.04	35.5
	TLZ39F	39F	38.14	40.11	85	250	5	0.5	0.04	36.2
	TLZ39G	39G	38.94	40.8	85	250	5	0.5	0.04	37
TLZ43	TLZ43	43	40	45	90	-	5	-	0.04	38
TLZ47	TLZ47	47	44	49	90	-	5	-	0.04	41.8
TLZ51	TLZ51	51	48	54	100	-	5	-	0.04	45.6
TLZ56	TLZ56	56	53	60	100	-	5	-	0.04	50.4

### Typical Characteristics ( $T_{amb} = 25^\circ C$ unless otherwise specified)

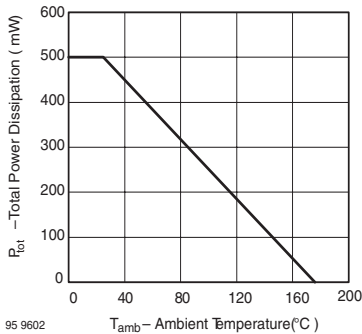

Figure 1. Total Power Dissipation vs. Ambient Temperature

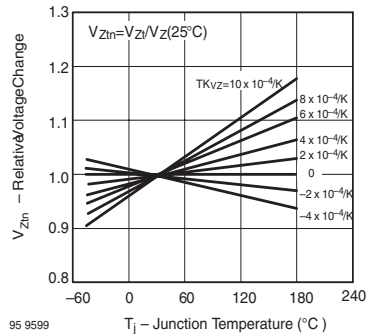

Figure 3. Typical Change of Working Voltage vs. Junction Temperature

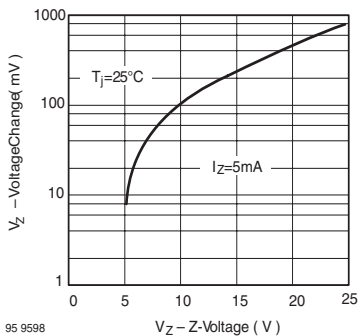

Figure 2. Typical Change of Working Voltage under Operating Conditions at  $T_{amb}=25^\circ C$

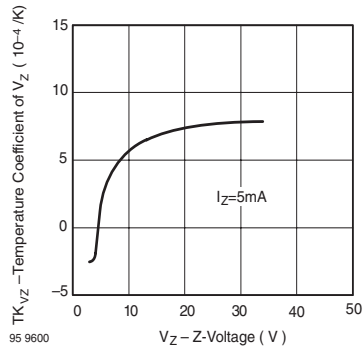

Figure 4. Temperature Coefficient of  $V_Z$  vs. Z-Voltage

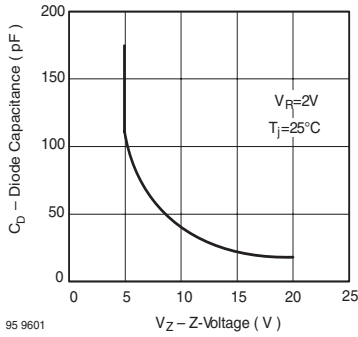

Figure 5. Diode Capacitance vs. Z-Voltage

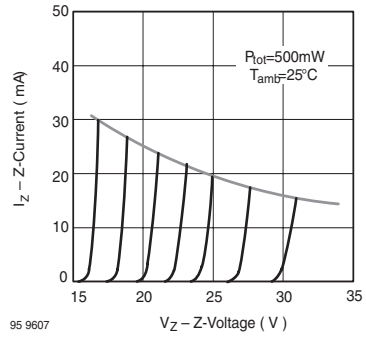

Figure 8. Z-Current vs. Z-Voltage

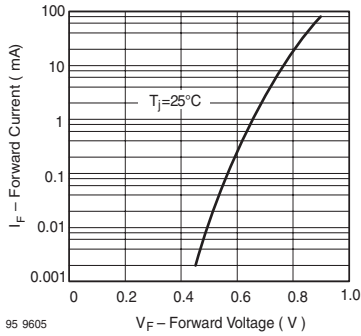

Figure 6. Forward Current vs. Forward Voltage

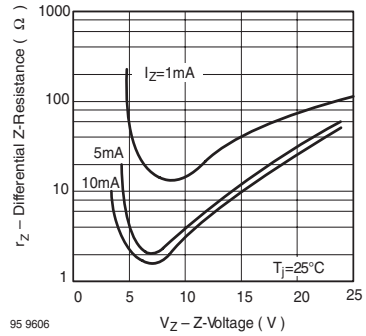

Figure 9. Differential Z-Resistance vs. Z-Voltage

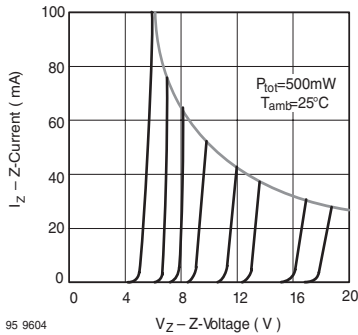

Figure 7. Z-Current vs. Z-Voltage

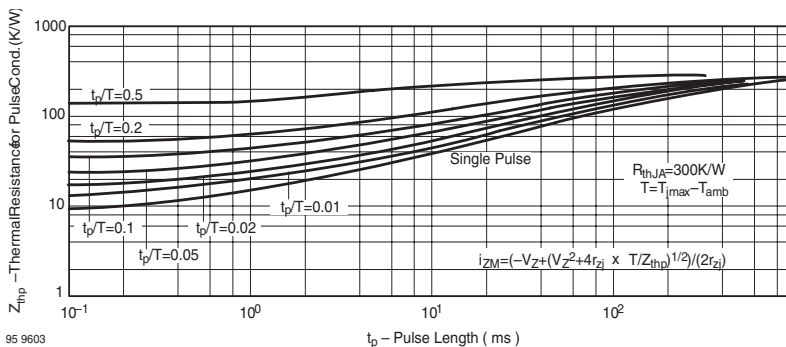
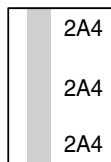
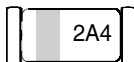

Figure 10. Thermal Response

### Marking Voltage Group

#### TLZ2V4A



#### TLZ2V4

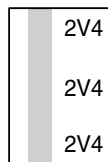

18660

### Remark:

The Zener voltage TLZ2V4 or Zener voltage group TLZ2V4A is printed with max 3 digits 3 times on the surface. The marking should be readable at minimum 2 times. The third print is allowed to be incomplete due to tolerances in Diameter of the glassbody.

### MiniMELF SOD-80 Package Dimension see Package Section

## Small Signal Zener Diodes

### Features

- Very sharp reverse characteristic
- Very high stability
- Electrical data identical with the devices 1N5221B...1N5267B
- Low reverse current level
- $V_Z$  - tolerance  $\pm 5\%$

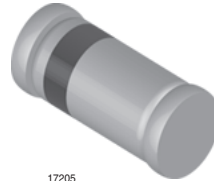

### Applications

Voltage stabilization

### Mechanical Data

**Case:** MiniMELF Glass case (SOD-80)

**Weight:** approx. 31 mg

**Packaging codes/ options:**

GS18 / 10 k per 13" reel (8 mm tape), 10 k/box

GS08 / 2.5 k per 7" reel (8 mm tape), 12.5 k/box

### Absolute Maximum Ratings

$T_{amb} = 25\text{ }^\circ\text{C}$ , unless otherwise specified

Parameter	Test condition	Symbol	Value	Unit
Power dissipation	$R_{thJA} < 300\text{ K/W}$ , $T_{amb} = 25\text{ }^\circ\text{C}$	$P_{tot}$	500	mW
Z-current		$I_Z$	$P_{tot}/V_Z$	mA
Junction temperature		$T_j$	175	$^\circ\text{C}$
Storage temperature range		$T_{stg}$	- 65 ... + 175	$^\circ\text{C}$

### Thermal Characteristics

$T_{amb} = 25\text{ }^\circ\text{C}$ , unless otherwise specified

Parameter	Test condition	Symbol	Value	Unit
Junction ambient	on PC board 50 mm x 50 mm x 1.6 mm	$R_{thJA}$	500	K/W

### Electrical Characteristics

$T_{amb} = 25\text{ }^\circ\text{C}$ , unless otherwise specified

Parameter	Test condition	Symbol	Min	Typ.	Max	Unit
Forward voltage	$I_F = 200\text{ mA}$	$V_F$			1.1	V



# TZM5221B to TZM5267B



Vishay Semiconductors

## Electrical Characteristics

Partnumber	Zener Voltage Range <sup>1)</sup>	Dynamic Resistance		Test Current		Reverse Leakage Current		Temperature Coefficient
	V <sub>Z</sub>	r <sub>ZT</sub> @ I <sub>ZT</sub>	r <sub>ZK</sub> @ I <sub>ZK</sub>	I <sub>ZT</sub>	I <sub>ZK</sub>	I <sub>R</sub>	@ V <sub>R</sub>	TK <sub>VZ</sub>
	V	Ω	Ω	mA	mA	μA	V	%/K
	typ	typ	typ					
TZM5221B	2.4	< 30	< 1200	20	0.25	< 100	1	< -0.085
TZM5222B	2.5	< 30	< 1250	20	0.25	< 100	1	< -0.085
TZM5223B	2.7	< 30	< 1300	20	0.25	< 75	1	< -0.080
TZM5224B	2.8	< 30	< 1400	20	0.25	< 75	1	< -0.080
TZM5225B	3	< 29	< 1600	20	0.25	< 50	1	< -0.075
TZM5226B	3.3	< 28	< 1600	20	0.25	< 25	1	< -0.070
TZM5227B	3.6	< 24	< 1700	20	0.25	< 15	1	< -0.065
TZM5228B	3.9	< 23	< 1900	20	0.25	< 10	1	< -0.060
TZM5229B	4.3	< 22	< 2000	20	0.25	< 5	1	< ± 0.055
TZM5230B	4.7	< 19	< 1900	20	0.25	< 5	2	< ± 0.030
TZM5231B	5.1	< 17	< 1600	20	0.25	< 5	2	< ± 0.030
TZM5232B	5.6	< 11	< 1600	20	0.25	< 5	3	< +0.038
TZM5233B	6	< 7	< 1600	20	0.25	< 5	3.5	< +0.038
TZM5234B	6.2	< 7	< 1000	20	0.25	< 5	4	< +0.045
TZM5235B	6.8	< 5	< 750	20	0.25	< 3	5	< +0.050
TZM5236B	7.5	< 6	< 500	20	0.25	< 3	6	< +0.058
TZM5237B	8.2	< 8	< 500	20	0.25	< 3	6.5	< +0.062
TZM5238B	8.7	< 8	< 600	20	0.25	< 3	6.5	< +0.065
TZM5239B	9.1	< 10	< 600	20	0.25	< 3	7	< +0.068
TZM5240B	10	< 17	< 600	20	0.25	< 3	8	< +0.075
TZM5241B	11	< 22	< 600	20	0.25	< 2	8.4	< +0.076
TZM5242B	12	< 30	< 600	20	0.25	< 1	9.1	< +0.077
TZM5243B	13	< 13	< 600	9.5	0.25	< 0.5	9.9	< +0.079
TZM5244B	14	< 15	< 600	9	0.25	< 0.1	10	< +0.082
TZM5245B	15	< 16	< 600	8.5	0.25	< 0.1	11	< +0.082
TZM5246B	16	< 17	< 600	7.8	0.25	< 0.1	12	< +0.083
TZM5247B	17	< 19	< 600	7.4	0.25	< 0.1	13	< +0.084
TZM5248B	18	< 21	< 600	7	0.25	< 0.1	14	< +0.085
TZM5249B	19	< 23	< 600	6.6	0.25	< 0.1	14	< +0.086
TZM5250B	20	< 25	< 600	6.2	0.25	< 0.1	15	< +0.086
TZM5251B	22	< 29	< 600	5.6	0.25	< 0.1	17	< +0.087
TZM5252B	24	< 33	< 600	5.2	0.25	< 0.1	18	< +0.088
TZM5253B	25	< 35	< 600	5	0.25	< 0.1	19	< +0.089
TZM5254B	27	< 41	< 600	4.6	0.25	< 0.1	21	< +0.090
TZM5255B	28	< 44	< 600	4.5	0.25	< 0.1	21	< +0.091
TZM5256B	30	< 49	< 600	4.2	0.25	< 0.1	23	< +0.091
TZM5257B	33	< 58	< 700	3.8	0.25	< 0.1	25	< +0.092
TZM5258B	36	< 70	< 700	3.4	0.25	< 0.1	27	< +0.093
TZM5259B	39	< 80	< 800	3.2	0.25	< 0.1	30	< +0.094
TZM5260B	43	< 93	< 900	3	0.25	< 0.1	33	< +0.095
TZM5261B	47	105	< 1000	2.7	0.25	< 0.1	36	< +0.095
TZM5262B	51	125	< 1100	2.5	0.25	< 0.1	39	< +0.096
TZM5263B	56	150	< 1300	2.2	0.25	< 0.1	43	< +0.096
TZM5264B	60	170	< 1400	2.1	0.25	< 0.1	46	< +0.097



# TZM5221B to TZM5267B

Vishay Semiconductors

Partnumber	Zener Voltage Range <sup>1)</sup>	Dynamic Resistance		Test Current		Reverse Leakage Current		Temperature Coefficient
		$r_{zT} @ I_{ZT}$	$r_{zK} @ I_{ZK}$	$I_{ZT}$	$I_{ZK}$	$I_R$	@ $V_R$	$TK_{VZ}$
		$\Omega$	$\Omega$	mA	mA	$\mu A$	V	%/K
	typ	typ	typ					
TZM5265B	62	185	< 1400	2	0.25	< 0.1	47	< +0.097
TZM5266B	68	230	< 1600	1.8	0.25	< 0.1	52	< +0.097
TZM5267B	75	270	< 1700	1.7	0.25	< 0.1	56	< +0.098

<sup>1)</sup> Based on dc-measurement at thermal equilibrium; case temperature maintained at 30 °C ± 2 °C.

**MiniMELF SOD-80 Package Dimension**  
see Package Section

# TZM5221B to TZM5267B

Vishay Semiconductors

---



## Small Signal Zener Diodes

### Features

- Very sharp reverse characteristic
- Low reverse current level
- Very high stability
- Low noise
- TZMC -  $V_Z$ -tolerance  $\pm 5\%$
- TZMB -  $V_Z$ -tolerance  $\pm 2\%$
- Available with tighter tolerances

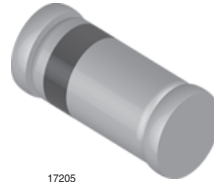

### Applications

Voltage stabilization

### Mechanical Data

**Case:** MiniMELF Glass case (SOD-80)

**Weight:** approx. 31 mg

#### Packaging codes/ options:

GS08 / 2.5 k per 7" reel (8 mm tape), 12.5 k/box

GS18 / 10 k per 13" reel (8 mm tape), 10 k/box

### Absolute Maximum Ratings

$T_{amb} = 25\text{ }^\circ\text{C}$ , unless otherwise specified

Parameter	Test condition	Symbol	Value	Unit
Power dissipation	$R_{thJA} \leq 300\text{ K/W}$	$P_{tot}$	500	mW
Z-current		$I_Z$	$P_{tot}/V_Z$	mA
Junction temperature		$T_j$	175	$^\circ\text{C}$
Storage temperature range		$T_{stg}$	- 65 to + 175	$^\circ\text{C}$

### Thermal Characteristics

$T_{amb} = 25\text{ }^\circ\text{C}$ , unless otherwise specified

Parameter	Test condition	Symbol	Value	Unit
Junction ambient	on PC board 50 mm x 50 mm x 1.6 mm	$R_{thJA}$	500	K/W

### Electrical Characteristics

$T_{amb} = 25\text{ }^\circ\text{C}$ , unless otherwise specified

Parameter	Test condition	Symbol	Min	Typ.	Max	Unit
Forward voltage	$I_F = 200\text{ mA}$	$V_F$			1.5	V

### Electrical Characteristics

Partnumber	Zener Voltage Range		Dynamic Resistance		Test Current		Reverse Leakage Current			Temperature Coefficient of Zener Voltage	
	$V_Z @ I_{ZT}$		$r_{zT} @ I_{ZT}$	$r_{zK} @ I_{ZK}$	$I_{ZT}$	$I_{ZK}$	$I_R$	$I_R^{(1)}$	@ $V_R$	$TK_{VZ}$	
	V	V	$\Omega$	$\Omega$	mA	mA	$\mu A$	$\mu A$	V	%/K	%/K
	min	max	typ	typ						min	max
TZMC2V4	2.28	2.56	< 85	< 600	5	1	< 50	< 100	1	-0.09	-0.06
TZMC2V7	2.5	2.9	< 85	< 600	5	1	< 10	< 50	1	-0.09	-0.06
TZMC3V0	2.8	3.2	< 90	< 600	5	1	< 4	< 40	1	-0.08	-0.05
TZMC3V3	3.1	3.5	< 90	< 600	5	1	< 2	< 40	1	-0.08	-0.05
TZMC3V6	3.4	3.8	< 90	< 600	5	1	< 2	< 40	1	-0.08	-0.05
TZMC3V9	3.7	4.1	< 90	< 600	5	1	< 2	< 40	1	-0.08	-0.05
TZMC4V3	4	4.6	< 90	< 600	5	1	< 1	< 20	1	-0.06	-0.03
TZMC4V7	4.4	5	< 80	< 600	5	1	< 0.5	< 10	1	-0.05	0.02
TZMC5V1	4.8	5.4	< 60	< 550	5	1	< 0.1	< 2	1	-0.02	0.02
TZMC5V6	5.2	6	< 40	< 450	5	1	< 0.1	< 2	1	-0.05	0.05
TZMC6V2	5.8	6.6	< 10	< 200	5	1	< 0.1	< 2	2	0.03	0.06
TZMC6V8	6.4	7.2	< 8	< 150	5	1	< 0.1	< 2	3	0.03	0.07
TZMC7V5	7	7.9	< 7	< 50	5	1	< 0.1	< 2	5	0.03	0.07
TZMC8V2	7.7	8.7	< 7	< 50	5	1	< 0.1	< 2	6.2	0.03	0.08
TZMC9V1	8.5	9.6	< 10	< 50	5	1	< 0.1	< 2	6.8	0.03	0.09
TZMC10	9.4	10.6	< 15	< 70	5	1	< 0.1	< 2	7.5	0.03	0.1
TZMC11	10.4	11.6	< 20	< 70	5	1	< 0.1	< 2	8.2	0.03	0.11
TZMC12	11.4	12.7	< 20	< 90	5	1	< 0.1	< 2	9.1	0.03	0.11
TZMC13	12.4	14.1	< 26	< 110	5	1	< 0.1	< 2	10	0.03	0.11
TZMC15	13.8	15.6	< 30	< 110	5	1	< 0.1	< 2	11	0.03	0.11
TZMC16	15.3	17.1	< 40	< 170	5	1	< 0.1	< 2	12	0.03	0.11
TZMC18	16.8	19.1	< 50	< 170	5	1	< 0.1	< 2	13	0.03	0.11
TZMC20	18.8	21.2	< 55	< 220	5	1	< 0.1	< 2	15	0.03	0.11
TZMC22	20.8	23.3	< 55	< 220	5	1	< 0.1	< 2	16	0.04	0.12
TZMC24	22.8	25.6	< 80	< 220	5	1	< 0.1	< 2	18	0.04	0.12
TZMC27	25.1	28.9	< 80	< 220	5	1	< 0.1	< 2	20	0.04	0.12
TZMC30	28	32	< 80	< 220	5	1	< 0.1	< 2	22	0.04	0.12
TZMC33	31	35	< 80	< 220	5	1	< 0.1	< 2	24	0.04	0.12
TZMC36	34	38	< 80	< 220	5	1	< 0.1	< 2	27	0.04	0.12
TZMC39	37	41	< 90	< 500	2.5	0.5	< 0.1	< 5	30	0.04	0.12
TZMC43	40	46	< 90	< 600	2.5	0.5	< 0.1	< 5	33	0.04	0.12
TZMC47	44	50	< 110	< 700	2.5	0.5	< 0.1	< 5	36	0.04	0.12
TZMC51	48	54	< 125	< 700	2.5	0.5	< 0.1	< 10	39	0.04	0.12
TZMC56	52	60	< 135	< 1000	2.5	0.5	< 0.1	< 10	43	0.04	0.12
TZMC62	58	66	< 150	< 1000	2.5	0.5	< 0.1	< 10	47	0.04	0.12
TZMC68	64	72	< 200	< 1000	2.5	0.5	< 0.1	< 10	51	0.04	0.12
TZMC75	70	79	< 250	< 1500	2.5	0.5	< 0.1	< 10	56	0.04	0.12

<sup>1)</sup> at  $T_j = 150^\circ C$



## Electrical Characteristics

Partnumber	Zener Voltage Range		Dynamic Resistance		Test Current		Reverse Leakage Current			Temperature Coefficient of Zener Voltage	
	$V_Z @ I_{ZT}$		$r_{zT} @ I_{ZT}$	$r_{zK} @ I_{ZK}$	$I_{ZT}$	$I_{ZK}$	$I_R$	$I_R^{(1)}$	@ $V_R$	$TK_{VZ}$	
	V	V	$\Omega$	$\Omega$	mA	mA	$\mu A$	$\mu A$	V	%/K	%/K
	min	max	typ	typ						min	max
TZMB2V4	2.35	2.45	< 85	< 600	5	1	< 50	< 100	1	-0.09	-0.06
TZMB2V7	2.64	2.76	< 85	< 600	5	1	< 10	< 50	1	-0.09	-0.06
TZMB3V0	2.94	3.06	< 90	< 600	5	1	< 4	< 40	1	-0.08	-0.05
TZMB3V3	3.24	3.36	< 90	< 600	5	1	< 2	< 40	1	-0.08	-0.05
TZMB3V6	3.52	3.68	< 90	< 600	5	1	< 2	< 40	1	-0.08	-0.05
TZMB3V9	3.82	3.98	< 90	< 600	5	1	< 2	< 40	1	-0.08	-0.05
TZMB4V3	4.22	4.38	< 90	< 600	5	1	< 1	< 20	1	-0.06	-0.03
TZMB4V7	4.6	4.8	< 80	< 600	5	1	< 0.5	< 10	1	-0.05	0.02
TZMB5V1	5	5.2	< 60	< 550	5	1	< 0.1	< 2	1	-0.02	0.02
TZMB5V6	5.48	5.72	< 40	< 450	5	1	< 0.1	< 2	1	-0.05	0.05
TZMB6V2	6.08	6.32	< 10	< 200	5	1	< 0.1	< 2	2	0.03	0.06
TZMB6V8	6.66	6.94	< 8	< 150	5	1	< 0.1	< 2	3	0.03	0.07
TZMB7V5	7.35	7.65	< 7	< 50	5	1	< 0.1	< 2	5	0.03	0.07
TZMB8V2	8.04	8.36	< 7	< 50	5	1	< 0.1	< 2	6.2	0.03	0.08
TZMB9V1	8.92	9.28	< 10	< 50	5	1	< 0.1	< 2	6.8	0.03	0.09
TZMB10	9.8	10.2	< 15	< 70	5	1	< 0.1	< 2	7.5	0.03	0.1
TZMB11	10.78	11.22	< 20	< 70	5	1	< 0.1	< 2	8.2	0.03	0.11
TZMB12	11.76	12.24	< 20	< 90	5	1	< 0.1	< 2	9.1	0.03	0.11
TZMB13	12.74	13.26	< 26	< 110	5	1	< 0.1	< 2	10	0.03	0.11
TZMB15	14.7	15.3	< 30	< 110	5	1	< 0.1	< 2	11	0.03	0.11
TZMB16	15.7	16.3	< 40	< 170	5	1	< 0.1	< 2	12	0.03	0.11
TZMB18	17.64	18.36	< 50	< 170	5	1	< 0.1	< 2	13	0.03	0.11
TZMB20	19.6	20.4	< 55	< 220	5	1	< 0.1	< 2	15	0.03	0.11
TZMB22	21.55	22.45	< 55	< 220	5	1	< 0.1	< 2	16	0.04	0.12
TZMB24	23.5	24.5	< 80	< 220	5	1	< 0.1	< 2	18	0.04	0.12
TZMB27	26.4	27.6	< 80	< 220	5	1	< 0.1	< 2	20	0.04	0.12
TZMB30	29.4	30.6	< 80	< 220	5	1	< 0.1	< 2	22	0.04	0.12
TZMB33	32.4	33.6	< 80	< 220	5	1	< 0.1	< 2	24	0.04	0.12
TZMB36	35.3	36.7	< 80	< 220	5	1	< 0.1	< 2	27	0.04	0.12
TZMB39	38.2	39.8	< 90	< 500	2.5	1	< 0.1	< 5	30	0.04	0.12
TZMB43	42.1	43.9	< 90	< 600	2.5	0.5	< 0.1	< 5	33	0.04	0.12
TZMB47	46.1	47.9	< 110	< 700	2.5	0.5	< 0.1	< 5	36	0.04	0.12
TZMB51	50	52	< 125	< 700	2.5	0.5	< 0.1	< 10	39	0.04	0.12
TZMB56	54.9	57.1	< 135	< 1000	2.5	0.5	< 0.1	< 10	43	0.04	0.12
TZMB62	60.8	63.2	< 150	< 1000	2.5	0.5	< 0.1	< 10	47	0.04	0.12
TZMB68	66.6	69.4	< 200	< 1000	2.5	0.5	< 0.1	< 10	51	0.04	0.12
TZMB75	73.5	76.5	< 250	< 1500	2.5	0.5	< 0.1	< 10	56	0.04	0.12

<sup>1)</sup> at  $T_j = 150\text{ }^\circ\text{C}$

NOTE: Additional measurement of voltage group TZMB9V1 to TZMB75,  $I_R$  at 95 %  $V_{Zmin} = < 35\text{ nA}$  at  $T_j = 25\text{ }^\circ\text{C}$

### Typical Characteristics ( $T_{amb} = 25\text{ }^{\circ}\text{C}$ unless otherwise specified)

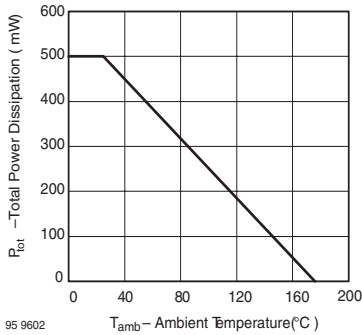

Figure 1. Total Power Dissipation vs. Ambient Temperature

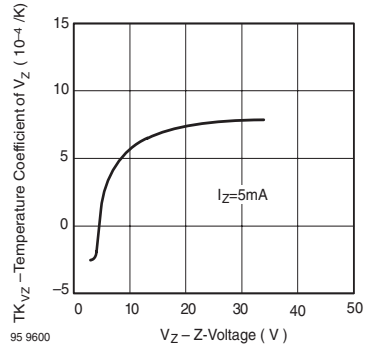

Figure 4. Temperature Coefficient of  $V_Z$  vs. Z-Voltage

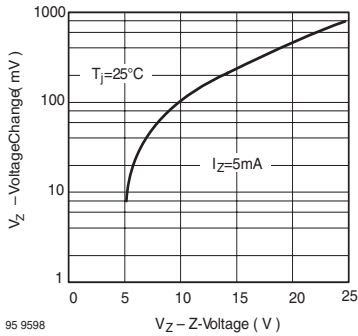

Figure 2. Typical Change of Working Voltage under Operating Conditions at  $T_{amb}=25\text{ }^{\circ}\text{C}$

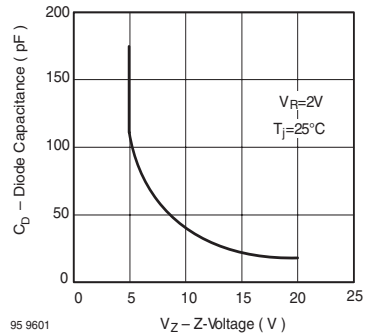

Figure 5. Diode Capacitance vs. Z-Voltage

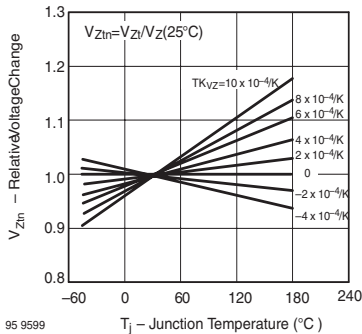

Figure 3. Typical Change of Working Voltage vs. Junction Temperature

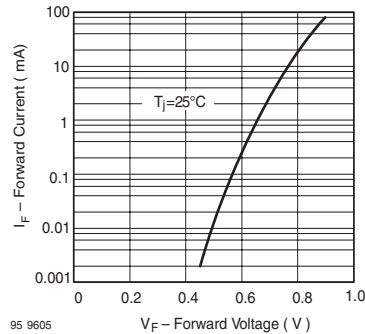

Figure 6. Forward Current vs. Forward Voltage

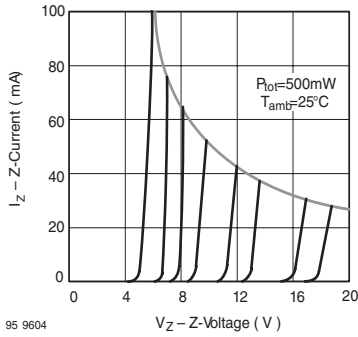

Figure 7. Z-Current vs. Z-Voltage

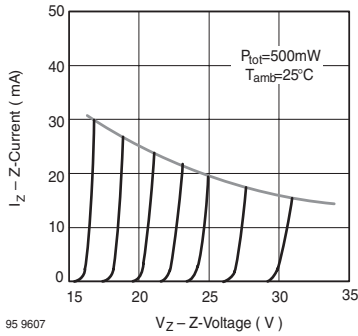

Figure 8. Z-Current vs. Z-Voltage

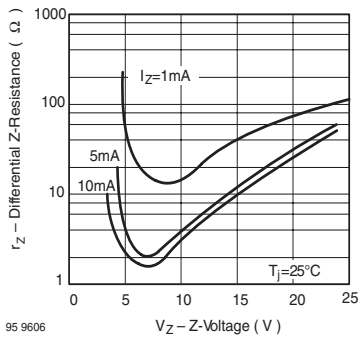

Figure 9. Differential Z-Resistance vs. Z-Voltage



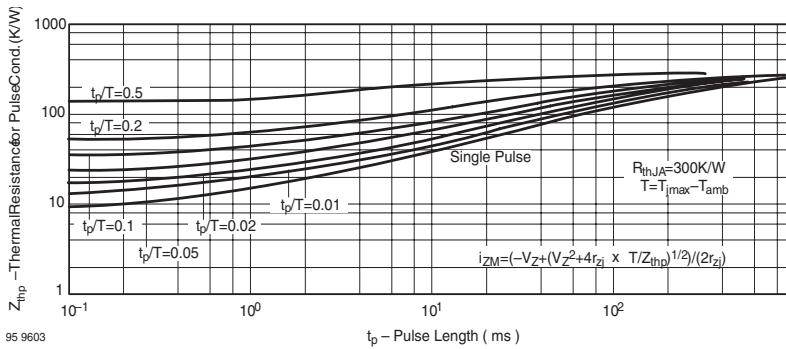

Figure 10. Thermal Response

## MiniMELF SOD-80 Package Dimension see Package Section

## Small Signal Zener Diodes

### Features

- Very sharp reverse characteristic
- Low reverse current level
- Available with tighter tolerances
- Very high stability
- Low noise
- $V_Z$  - tolerance  $\pm 5\%$

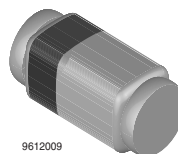

### Applications

Voltage stabilization

### Mechanical Data

**Case:** QuadMELF Glass case (SOD-80)

**Weight:** approx. 34 mg

**Packaging Codes/Options:**

GS18 / 10 k per 13" reel 10 k/box

GS08 / 2.5 k per 7" reel 12.5 k/box

### Absolute Maximum Ratings

$T_{amb} = 25\text{ }^{\circ}\text{C}$ , unless otherwise specified

Parameter	Test condition	Symbol	Value	Unit
Power dissipation	$R_{thJA} \leq 300\text{ K/W}$	$P_{tot}$	500	mW
Z-current		$I_Z$	$P_{tot}/V_Z$	mA
Junction temperature		$T_j$	175	$^{\circ}\text{C}$
Storage temperature range		$T_{stg}$	- 65 to + 175	$^{\circ}\text{C}$

### Thermal Characteristics

$T_{amb} = 25\text{ }^{\circ}\text{C}$ , unless otherwise specified

Parameter	Test condition	Symbol	Value	Unit
Junction ambient	on PC board 50 mm x 50 mm x 1.6 mm	$R_{thJA}$	500	K/W

### Electrical Characteristics

$T_{amb} = 25\text{ }^{\circ}\text{C}$ , unless otherwise specified

Parameter	Test condition	Symbol	Min	Typ.	Max	Unit
Forward voltage	$I_F = 200\text{ mA}$	$V_F$			1.5	V

# TZQ5221B to TZQ5267B



Vishay Semiconductors

## Electrical Characteristics

Partnumber	Zener Voltage	Dynamic Resistance		Test Current		Temperature Coefficient of Zener Voltage	Reverse Leakage Current	
	$V_{Znom}$	$r_{zT} @ I_{ZT}$	$r_{zK} @ I_{ZK}$	$I_{ZT}$	$I_{ZK}$	TK <sub>VZ</sub>	$I_R$	@ $V_R$
	V	Ω	Ω	mA	mA	%/K	μA	V
TZQ5221B	2.4	< 30	< 1200	20	0.25	< -0.085	< 100	1
TZQ5222B	2.5	< 30	< 1250	20	0.25	< -0.085	< 100	1
TZQ5223B	2.7	< 30	< 1300	20	0.25	< -0.080	< 75	1
TZQ5224B	2.8	< 30	< 1400	20	0.25	< -0.080	< 75	1
TZQ5225B	3	< 29	< 1600	20	0.25	< -0.075	< 50	1
TZQ5226B	3.3	< 28	< 1600	20	0.25	< -0.070	< 25	1
TZQ5227B	3.6	< 24	< 1700	20	0.25	< -0.065	< 15	1
TZQ5228B	3.9	< 23	< 1900	20	0.25	< -0.060	< 10	1
TZQ5229B	4.3	< 22	< 2000	20	0.25	< ±0.055	< 5	1
TZQ5230B	4.7	< 19	< 1900	20	0.25	< ±0.030	< 5	2
TZQ5231B	5.1	< 17	< 1600	20	0.25	< ±0.030	< 5	2
TZQ5232B	5.6	< 11	< 1600	20	0.25	< +0.038	< 5	3
TZQ5233B	6	< 7	< 1600	20	0.25	< +0.038	< 5	3.5
TZQ5234B	6.2	< 7	< 1000	20	0.25	< +0.045	< 5	4
TZQ5235B	6.8	< 5	< 750	20	0.25	< +0.050	< 3	5
TZQ5236B	7.5	< 6	< 500	20	0.25	< +0.058	< 3	6
TZQ5237B	8.2	< 8	< 500	20	0.25	< +0.062	< 3	6.5
TZQ5238B	8.7	< 8	< 600	20	0.25	< +0.065	< 3	6.5
TZQ5239B	9.1	< 10	< 600	20	0.25	< +0.068	< 3	7
TZQ5240B	10	< 17	< 600	20	0.25	< +0.075	< 3	8
TZQ5241B	11	< 22	< 600	20	0.25	< +0.076	< 2	8.4
TZQ5242B	12	< 30	< 600	20	0.25	< +0.077	< 1	9.1
TZQ5243B	13	< 13	< 600	9.5	0.25	< +0.079	< 0.5	9.9
TZQ5244B	14	< 15	< 600	9	0.25	< +0.082	< 0.1	10
TZQ5245B	15	< 16	< 600	8.5	0.25	< +0.082	< 0.1	11
TZQ5246B	16	< 17	< 600	7.8	0.25	< +0.083	< 0.1	12
TZQ5247B	17	< 19	< 600	7.4	0.25	< +0.084	< 0.1	13
TZQ5248B	18	< 21	< 600	7	0.25	< +0.085	< 0.1	14
TZQ5249B	19	< 23	< 600	6.6	0.25	< +0.086	< 0.1	14
TZQ5250B	20	< 25	< 600	6.2	0.25	< +0.086	< 0.1	15
TZQ5251B	22	< 29	< 600	5.6	0.25	< +0.087	< 0.1	17
TZQ5252B	24	< 33	< 600	5.2	0.25	< +0.088	< 0.1	18
TZQ5253B	25	< 35	< 600	5	0.25	< +0.089	< 0.1	19
TZQ5254B	27	< 41	< 600	4.6	0.25	< +0.090	< 0.1	21
TZQ5255B	28	< 44	< 600	4.5	0.25	< +0.091	< 0.1	21
TZQ5256B	30	< 49	< 600	4.2	0.25	< +0.091	< 0.1	23
TZQ5257B	33	< 58	< 700	3.8	0.25	< +0.092	< 0.1	25
TZQ5258B	36	< 70	< 700	3.4	0.25	< +0.093	< 0.1	27
TZQ5259B	39	< 80	< 800	3.2	0.25	< +0.094	< 0.1	30
TZQ5260B	43	< 93	< 900	3	0.25	< +0.095	< 0.1	33
TZQ5261B	47	< 105	< 1000	2.7	0.25	< +0.095	< 0.1	36
TZQ5262B	51	< 125	< 1100	2.5	0.25	< +0.096	< 0.1	39
TZQ5263B	56	< 150	< 1300	2.2	0.25	< +0.096	< 0.1	43
TZQ5264B	60	< 170	< 1400	2.1	0.25	< +0.097	< 0.1	46
TZQ5265B	62	< 185	< 1400	2	0.25	< +0.097	< 0.1	47
TZQ5266B	68	< 230	< 1600	1.8	0.25	< +0.097	< 0.1	52
TZQ5267B	75	< 270	< 1700	1.7	0.25	< +0.098	< 0.1	56

<sup>1)</sup> Based on dc measurement at thermal equilibrium; case temperature maintained at 30 °C ± 2 °C.

## Typical Characteristics ( $T_{amb} = 25^\circ\text{C}$ unless otherwise specified)

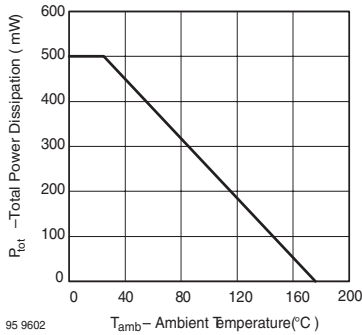

Figure 1. Total Power Dissipation vs. Ambient Temperature

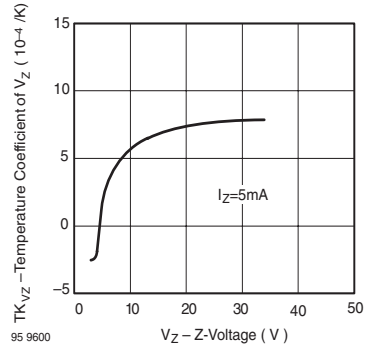

Figure 4. Temperature Coefficient of  $V_Z$  vs. Z-Voltage

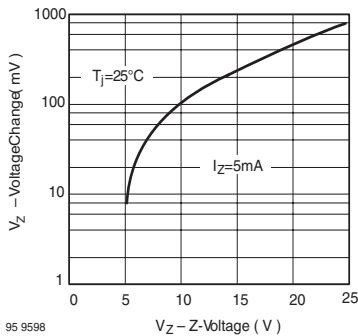

Figure 2. Typical Change of Working Voltage under Operating Conditions at  $T_{amb}=25^\circ\text{C}$

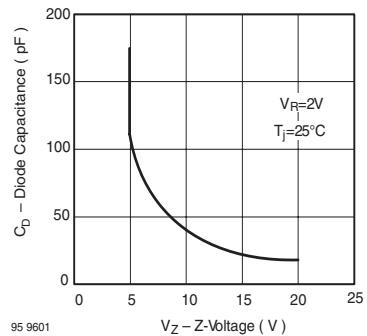

Figure 5. Diode Capacitance vs. Z-Voltage

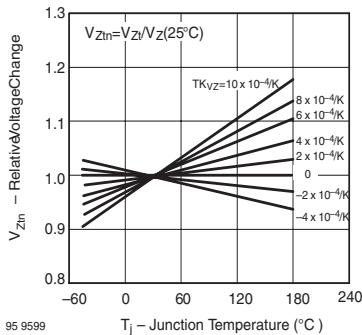

Figure 3. Typical Change of Working Voltage vs. Junction Temperature

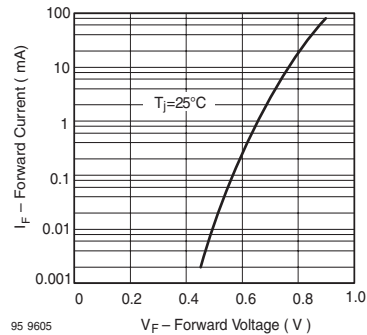

Figure 6. Forward Current vs. Forward Voltage

# TZQ5221B to TZQ5267B

Vishay Semiconductors

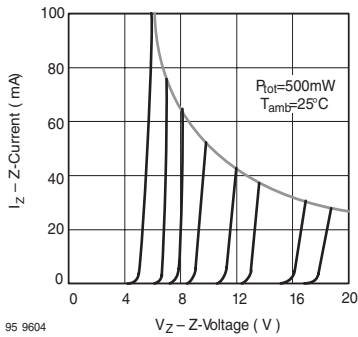

Figure 7. Z-Current vs. Z-Voltage

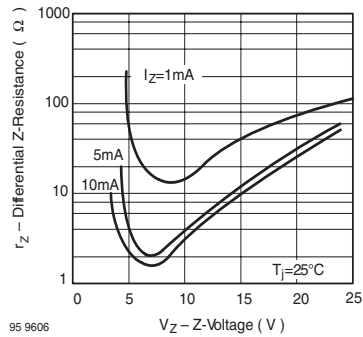

Figure 9. Differential Z-Resistance vs. Z-Voltage

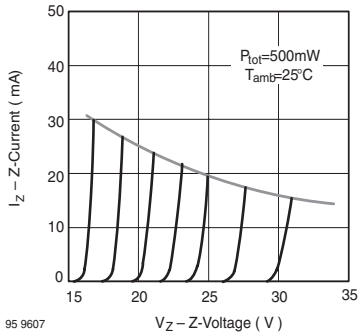

Figure 8. Z-Current vs. Z-Voltage

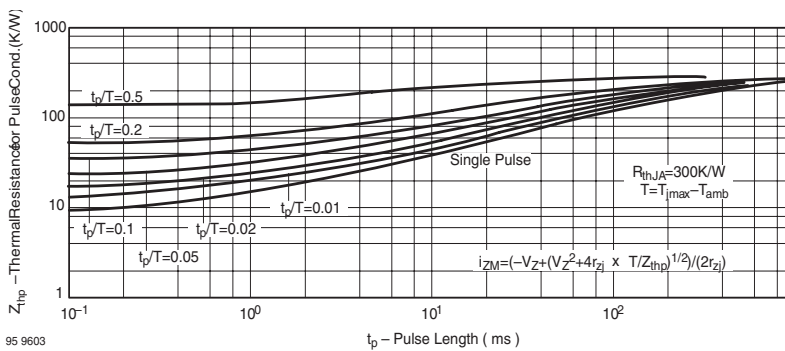

Figure 10. Thermal Response

**QuadMELF SOD-80**  
**Package Dimension**  
**see Package Section**

## Small Signal Zener Diodes

### Features

- Zener voltage specified at 50  $\mu\text{A}$
- Maximum delta  $V_Z$  given from 10  $\mu\text{A}$  to 100  $\mu\text{A}$
- Very high stability
- Low noise

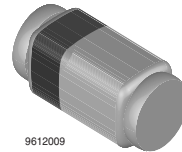

### Applications

Voltage stabilization

### Mechanical Data

**Case:** QuadroMELF Glass case (SOD-80)

**Weight:** approx. 34 mg

**Packaging Codes/Options:**

GS08 / 2.5 k per 7" reel 12.5 k/box

### Absolute Maximum Ratings

$T_{\text{amb}} = 25\text{ }^{\circ}\text{C}$ , unless otherwise specified

Parameter	Test condition	Symbol	Value	Unit
Power dissipation	$R_{\text{thJA}} \leq 300\text{ K/W}$	$P_{\text{tot}}$	500	mW
Z-current		$I_Z$	$P_{\text{tot}}/V_Z$	mA
Junction temperature		$T_j$	175	$^{\circ}\text{C}$
Storage temperature range		$T_{\text{stg}}$	- 65 to + 175	$^{\circ}\text{C}$

### Thermal Characteristics

$T_{\text{amb}} = 25\text{ }^{\circ}\text{C}$ , unless otherwise specified

Parameter	Test condition	Symbol	Value	Unit
Junction ambient	on PC board 50 mm x 50 mm x 1.6 mm	$R_{\text{thJA}}$	500	K/W

### Electrical Characteristics

$T_{\text{amb}} = 25\text{ }^{\circ}\text{C}$ , unless otherwise specified

Parameter	Test condition	Symbol	Min	Typ.	Max	Unit
Forward voltage	$I_F = 100\text{ mA}$	$V_F$			1.5	V

### Electrical Characteristics

Partnumber	Zener Voltage			Max. Zener Current	Max. Voltage Change	Max. Reverse Current	Test Voltage
	$V_Z @ I_Z = 50 \mu A$			$I_{ZM}^{(2)}$	$\Delta V_Z^{(4)}$	$I_R^{(3)}$	$V_R^{(3)}$
	V			mA	V	$\mu A$	V
	typ <sup>1)</sup>	min	max				
TZS4678	1.8	1.71	1.89	120	0.7	7.5	1
TZS4679	2	1.9	2.1	110	0.7	5	1
TZS4680	2.2	2.09	2.31	100	0.75	4	1
TZS4681	2.4	2.28	2.52	95	0.80	2	1
TZS4682	2.7	2.565	2.835	90	0.85	1	1
TZS4683	3	2.85	3.15	85	0.90	0.80	1
TZS4684	3.3	3.135	3.465	80	0.95	7.5	1.5
TZS4685	3.6	3.42	3.78	75	0.95	7.5	2
TZS4686	3.9	3.705	4.095	70	0.97	5	2
TZS4687	4.3	4.085	4.515	65	0.99	4	2
TZS4688	4.7	4.465	4.935	60	0.99	10	3
TZS4689	5.1	4.845	5.355	55	0.97	10	3
TZS4690	5.6	5.32	5.88	50	0.96	10	4
TZS4691	6.2	5.89	6.51	45	0.95	10	5
TZS4692	6.8	6.46	7.14	35	0.90	10	5.1
TZS4693	7.5	7.125	7.875	31.8	0.75	10	5.7
TZS4694	8.2	7.79	8.61	29	0.5	1	6.2
TZS4695	8.7	8.265	9.135	27.4	0.1	1	6.6
TZS4696	9.1	8.645	9.555	26.2	0.08	1	6.9
TZS4697	10	9.5	10.5	24.8	0.1	1	7.6
TZS4698	11	10.45	11.55	21.6	0.11	0.05	8.4
TZS4699	12	11.4	12.6	20.4	0.12	0.05	9.1
TZS4700	13	12.35	13.65	19	0.13	0.05	9.8
TZS4701	14	13.3	14.7	17.5	0.14	0.05	10.6
TZS4702	15	14.25	15.75	16.3	0.15	0.05	11.4
TZS4703	16	15.2	16.8	15.4	0.16	0.05	12.1
TZS4704	17	16.15	17.85	14.5	0.17	0.05	12.9
TZS4705	18	17.1	18.9	13.2	0.18	0.05	13.6
TZS4706	19	18.05	19.95	12.5	0.19	0.05	14.4
TZS4707	20	19	21	11.9	0.2	0.01	15.2
TZS4708	22	20.9	23.1	10.8	0.22	0.01	16.7
TZS4709	24	22.8	25.2	9.9	0.24	0.01	18.2
TZS4710	25	23.75	26.25	9.5	0.25	0.01	19
TZS4711	27	25.65	28.35	8.8	0.27	0.01	20.4
TZS4712	28	26.6	29.4	8.5	0.28	0.01	21.2
TZS4713	30	28.5	31.5	7.9	0.3	0.01	22.8
TZS4714	33	31.35	34.65	7.2	0.33	0.01	25
TZS4715	36	34.2	37.8	6.6	0.36	0.01	27.3
TZS4716	39	37.05	40.95	6.1	0.39	0.01	29.6
TZS4717	43	40.85	45.15	5.5	0.43	0.01	32.6

<sup>1)</sup> Tolerancing and voltage designation ( $V_Z$ ). The type numbers shown have a standard tolerance of  $\pm 5\%$  on the nominal zener voltage.

<sup>2)</sup> Maximum zener current ratings ( $I_{ZM}$ ). Maximum zener current ratings are based on maximum zener voltage of the individual units.

<sup>3)</sup> Reverse leakage current ( $I_R$ ). Reverse leakage currents are guaranteed and measured at  $V_R$  as shown on the table.

<sup>4)</sup> Maximum voltage change ( $\Delta V_Z$ ). Voltage change is equal to the difference between  $V_Z$  at  $100 \mu A$  and  $V_Z$  at  $10 \mu A$ .

## Typical Characteristics ( $T_{amb} = 25^\circ\text{C}$ unless otherwise specified)

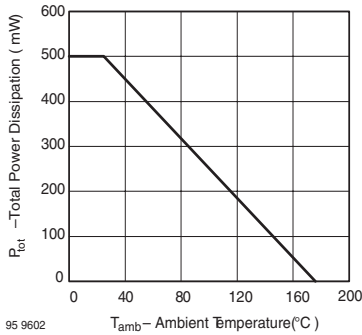

Figure 1. Total Power Dissipation vs. Ambient Temperature

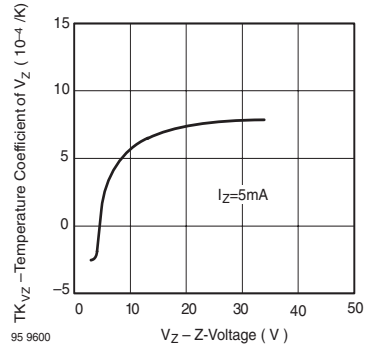

Figure 4. Temperature Coefficient of  $V_Z$  vs. Z-Voltage

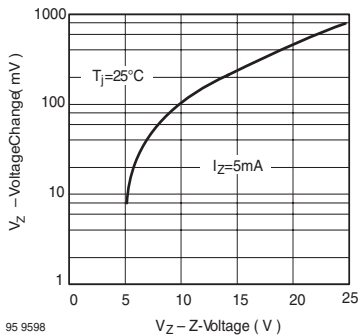

Figure 2. Typical Change of Working Voltage under Operating Conditions at  $T_{amb}=25^\circ\text{C}$

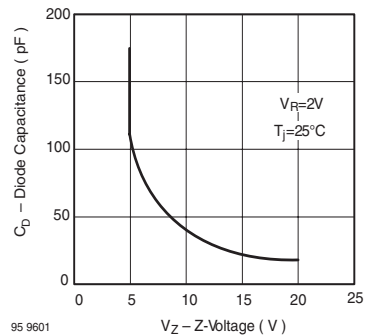

Figure 5. Diode Capacitance vs. Z-Voltage

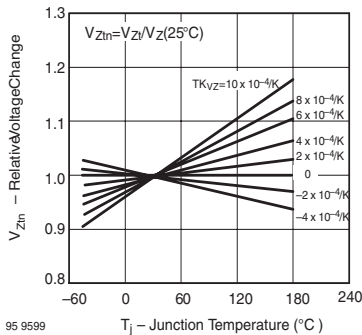

Figure 3. Typical Change of Working Voltage vs. Junction Temperature

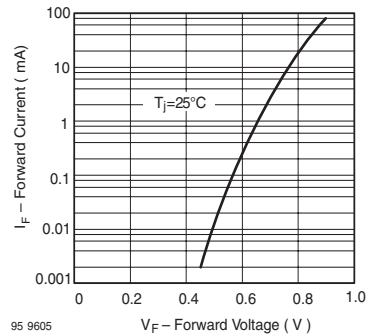

Figure 6. Forward Current vs. Forward Voltage



# TZS4678 to TZS4717

Vishay Semiconductors

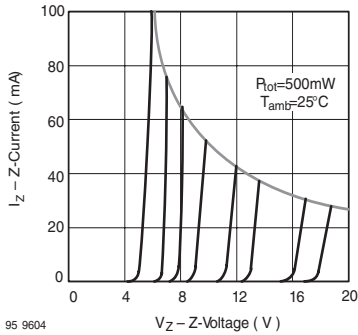

Figure 7. Z-Current vs. Z-Voltage

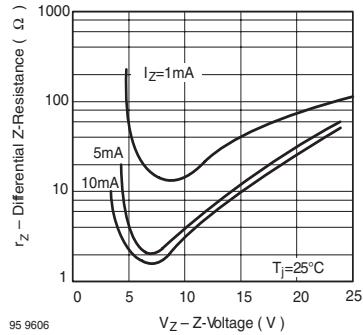

Figure 9. Differential Z-Resistance vs. Z-Voltage

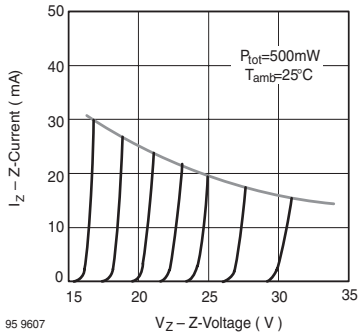

Figure 8. Z-Current vs. Z-Voltage

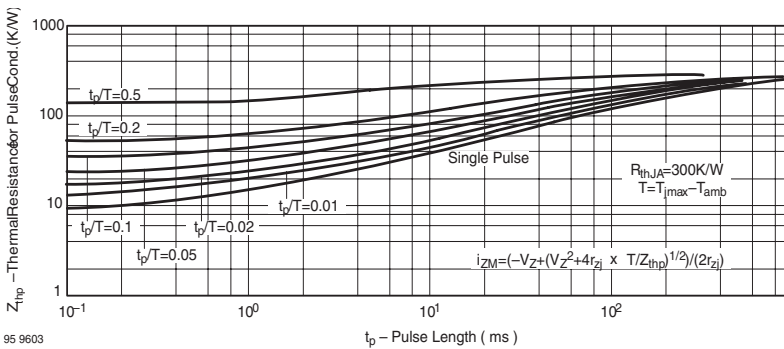

Figure 10. Thermal Response

**QuadMELF SOD-80**  
**Package Dimension**  
**see Package Section**

## Small Signal Zener Diodes

### Features

- Very sharp reverse characteristic
- Low reverse current level
- Very high stability
- Low noise

### Applications

Voltage stabilization

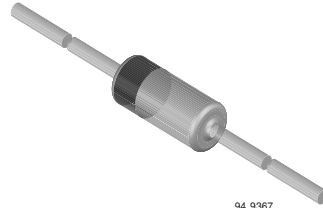

94 9367

### Mechanical Data

**Case:** DO-35 Glass case

**Weight:** approx. 125 mg

**Packaging codes/options:**

TAP / 10 k per Ammopack (52 mm tape), 30 k/box

### Absolute Maximum Ratings

$T_{amb} = 25\text{ }^{\circ}\text{C}$ , unless otherwise specified

Parameter	Test condition	Symbol	Value	Unit
Power dissipation	$l = 4\text{ mm}$ , $T_L = 25\text{ }^{\circ}\text{C}$	$P_{tot}$	500	mW
Z-current		$I_Z$	$P_{tot}/V_Z$	mA
Junction temperature		$T_j$	175	$^{\circ}\text{C}$
Storage temperature range		$T_{stg}$	- 65 to +175	$^{\circ}\text{C}$

### Thermal Characteristics

$T_{amb} = 25\text{ }^{\circ}\text{C}$ , unless otherwise specified

Parameter	Test condition	Symbol	Value	Unit
Junction ambient	$l = 4\text{ mm}$ , $T_L = \text{constant}$	$R_{thJA}$	300	K/W

### Electrical Characteristics

$T_{amb} = 25\text{ }^{\circ}\text{C}$ , unless otherwise specified

Parameter	Test condition	Symbol	Min	Typ.	Max	Unit
Forward voltage	$I_F = 200\text{ mA}$	$V_F$			1.5	V

### Electrical Characteristics

Partnumber group	Partnumber	Zener Voltage		Dynamic Resistance	Test Current	Reverse Leakage Current			
		$V_Z @ I_Z$				$r_Z @ I_Z$	$I_Z$	$I_R$	@ $V_R$
		V	V	$\Omega$	mA	$\mu A$	V	$\mu A$	V
		min	max	max		max		max	
TZX2V4	TZX2V4A	2.3	2.5	100	5	5	0.5	50	1
	TZX2V4B	2.4	2.6	100	5	5	0.5	50	1
TZX2V7	TZX2V7A	2.5	2.7	100	5	5	0.5	10	1
	TZX2V7B	2.6	2.8	100	5	5	0.5	10	1
	TZX2V7C	2.7	2.9	100	5	5	0.5	10	1
TZX3V0	TZX3V0A	2.8	3	100	5	5	0.5	6	1
	TZX3V0B	2.9	3.1	100	5	5	0.5	6	1
	TZX3V0C	3	3.2	100	5	5	0.5	6	1
TZX3V3	TZX3V3A	3.1	3.3	100	5	5	1	2	1
	TZX3V3B	3.2	3.4	100	5	5	1	2	1
	TZX3V3C	3.3	3.5	100	5	5	1	2	1
TZX3V6	TZX3V6A	3.4	3.6	100	5	5	1	2	1
	TZX3V6B	3.5	3.7	100	5	5	1	2	1
	TZX3V6C	3.6	3.8	100	5	5	1	2	1
TZX3V9	TZX3V9A	3.7	3.9	100	5	5	1	2	1
	TZX3V9B	3.8	4	100	5	5	1	2	1
	TZX3V9C	3.9	4.1	100	5	5	1	2	1
TZX4V3	TZX4V3A	4	4.2	100	5	5	1.5	1	1
	TZX4V3B	4.1	4.3	100	5	5	1.5	1	1
	TZX4V3C	4.2	4.4	100	5	5	1.5	1	1
	TZX4V3D	4.3	4.5	100	5	5	1.5	1	1
TZX4V7	TZX4V7A	4.4	4.6	100	5	5	2	6	2
	TZX4V7B	4.5	4.7	100	5	5	2	5	2
	TZX4V7C	4.6	4.8	100	5	5	2	4	2
	TZX4V7D	4.7	4.9	100	5	5	2	3	2
TZX5V1	TZX5V1A	4.8	5	100	5	5	2	2	2
	TZX5V1B	4.9	5.1	100	5	5	2	2	2
	TZX5V1C	5	5.2	100	5	5	2	2	2
	TZX5V1D	5.1	5.3	100	5	5	2	2	2
TZX5V6	TZX5V6A	5.2	5.5	40	5	5	2	1	2
	TZX5V6B	5.3	5.6	40	5	5	2	1	2
	TZX5V6C	5.4	5.7	40	5	5	2	1	2
	TZX5V6D	5.5	5.8	40	5	5	2	1	2
	TZX5V6E	5.6	5.9	40	5	5	2	1	2
TZX6V2	TZX6V2A	5.7	6	15	5	1	3	3	4
	TZX6V2B	5.8	6.1	15	5	1	3	3	4
	TZX6V2C	6	6.3	15	5	1	3	3	4
	TZX6V2D	6.1	6.4	15	5	1	3	3	4
	TZX6V2E	6.3	6.6	15	5	1	3	3	4
TZX6V8	TZX6V8A	6.4	6.7	15	5	1	3.5	2	4
	TZX6V8B	6.6	6.9	15	5	1	3.5	2	4
	TZX6V8C	6.7	7	15	5	1	3.5	2	4
	TZX6V8D	6.9	7.2	15	5	1	3.5	2	4



Partnumber group	Partnumber	Zener Voltage		Dynamic Resistance	Test Current	Reverse Leakage Current			
		$V_Z @ I_Z$		$r_Z @ I_Z$	$I_Z$	$I_R$	@ $V_R$	$I_R^{(1)}$	@ $V_R^{(1)}$
		V	V	$\Omega$	mA	$\mu A$	V	$\mu A$	V
		min	max	max		max		max	
TZX7V5	TZX7V5A	7	7.3	15	5	1	5	30	6.65
	TZX7V5B	7.2	7.6	15	5	1	5	30	6.84
	TZX7V5C	7.3	7.7	15	5	1	5	30	6.94
	TZX7V5D	7.5	7.9	15	5	1	5	30	7.13
	TZX7V5X	7.07	7.45	15	5	1	5	30	6.72
TZX8V2	TZX8V2A	7.7	8.1	20	5	1	6.2	0.1	7.32
	TZX8V2B	7.9	8.3	20	5	1	6.2	0.1	7.5
	TZX8V2C	8.1	8.5	20	5	1	6.2	0.1	7.7
	TZX8V2D	8.3	8.7	20	5	1	6.2	0.1	7.98
TZX9V1	TZX9V1A	8.5	8.9	20	5	1	6.8	0.04	8.08
	TZX9V1B	8.7	9.1	20	5	1	6.8	0.04	8.27
	TZX9V1C	8.9	9.3	20	5	1	6.8	0.04	8.46
	TZX9V1D	9.1	9.5	20	5	1	6.8	0.04	8.65
	TZX9V1E	9.3	9.7	20	5	1	6.8	0.04	8.84
TZX10	TZX10A	9.5	9.9	25	5	1	7.5	0.04	9.03
	TZX10B	9.7	10.1	25	5	1	7.5	0.04	9.22
	TZX10C	9.9	10.3	25	5	1	7.5	0.04	9.41
	TZX10D	10.2	10.6	25	5	1	7.5	0.04	9.69
TZX11	TZX11A	10.4	10.8	25	5	1	8.2	0.04	9.88
	TZX11B	10.7	11.1	25	5	1	8.2	0.04	10.2
	TZX11C	10.9	11.3	25	5	1	8.2	0.04	10.4
	TZX11D	11.1	11.6	25	5	1	8.2	0.04	10.5
TZX12	TZX12A	11.4	11.9	35	5	1	9.5	0.04	10.8
	TZX12B	11.6	12.1	35	5	1	9.5	0.04	11
	TZX12C	11.9	12.4	35	5	1	9.5	0.04	11.3
	TZX12D	12.2	12.7	35	5	1	9.5	0.04	11.6
	TZX12X	11.44	12.03	35	5	1	9.5	0.04	10.9
TZX13	TZX13A	12.4	12.9	35	5	1	10	0.04	11.8
	TZX13B	12.6	13.1	35	5	1	10	0.04	12
	TZX13C	12.9	13.4	35	5	1	10	0.04	12.3
TZX14	TZX14A	13.2	13.7	35	5	1	11	0.04	12.5
	TZX14B	13.5	14	35	5	1	11	0.04	12.8
	TZX14C	13.8	14.3	35	5	1	11	0.04	13.1
TZX15	TZX15A	14.1	14.7	40	5	1	11.5	0.04	13.4
	TZX15B	14.5	15.1	40	5	1	11.5	0.04	13.8
	TZX15C	14.9	15.5	40	5	1	11.5	0.04	14.2
	TZX15X	14.35	15.09	40	5	1	11.5	0.04	13.6
TZX16	TZX16A	15.3	15.9	45	5	1	12	0.04	14.5
	TZX16B	15.7	16.5	45	5	1	12	0.04	14.9
	TZX16C	16.3	17.1	45	5	1	12	0.04	15.5
TZX18A	TZX18A	16.9	17.7	55	5	1	13	0.04	16.1
	TZX18B	17.5	18.3	55	5	1	13	0.04	16.6
	TZX18C	18.1	19	55	5	1	13	0.04	17.2
TZX20A	TZX20A	18.8	19.7	60	2	1	15	0.04	17.9
	TZX20B	19.5	20.4	60	2	1	15	0.04	18.5
	TZX20C	20.2	21.2	60	2	1	15	0.04	19.2

Partnumber group	Partnumber	Zener Voltage		Dynamic Resistance	Test Current	Reverse Leakage Current			
		$V_Z @ I_Z$		$r_Z @ I_Z$	$I_Z$	$I_R$	@ $V_R$	$I_R^{(1)}$	@ $V_R^{(1)}$
		V	V	$\Omega$	mA	$\mu A$	V	$\mu A$	V
		min	max	max		max		max	
TZX22	TZX22A	20.9	21.9	65	2	1	17	0.04	19.9
	TZX22B	21.6	22.6	65	2	1	17	0.04	20.5
	TZX22C	22.3	23.3	65	2	1	17	0.04	21.2
TZX24	TZX24A	22.9	24	70	2	1	19	0.04	21.8
	TZX24B	23.6	24.7	70	2	1	19	0.04	22.4
	TZX24C	24.3	25.5	70	2	1	19	0.04	23.1
	TZX24X	22.61	23.77	70	2	1	19	0.04	21.5
TZX27	TZX27A	25.2	26.6	80	2	1	21	0.04	23.9
	TZX27B	26.2	27.6	80	2	1	21	0.04	24.9
	TZX27C	27.2	28.6	80	2	1	21	0.04	25.8
	TZX27X	26.99	28.39	80	2	1	21	0.04	25.6
TZX30	TZX30A	28.2	29.6	100	2	1	23	0.04	26.8
	TZX30B	29.2	30.6	100	2	1	23	0.04	27.7
	TZX30C	30.2	31.6	100	2	1	23	0.04	28.7
	TZX30X	29.02	30.51	100	2	1	23	0.04	27.6
TZX33	TZX33A	31.2	32.6	120	2	1	25	0.04	29.6
	TZX33B	32.2	33.6	120	2	1	25	0.04	30.6
	TZX33C	33.2	34.5	120	2	1	25	0.04	31.5
TZX36	TZX36A	34.2	35.7	140	2	1	27	0.04	32.5
	TZX36B	35.3	36.8	140	2	1	27	0.04	33.5
	TZX36C	36.4	38	140	2	1	27	0.04	34.6
	TZX36X	35.36	37.19	140	2	1	27	0.04	33.6

<sup>1)</sup> Additional measurement

NOTE: Additional measurement of voltage group TZM9V1 to TZX36,  $I_R$  at 95 %  $V_{Zmin} \leq 40$  nA at  $T_j = 25$  °C

## Typical Characteristics ( $T_{amb} = 25$ °C unless otherwise specified)

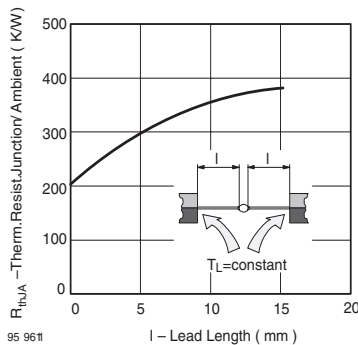

Figure 1. Thermal Resistance vs. Lead Length

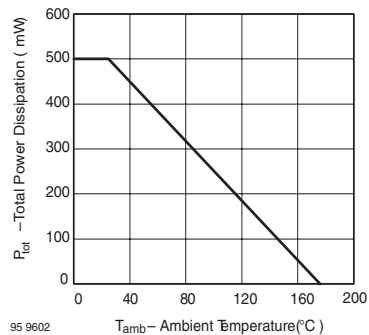
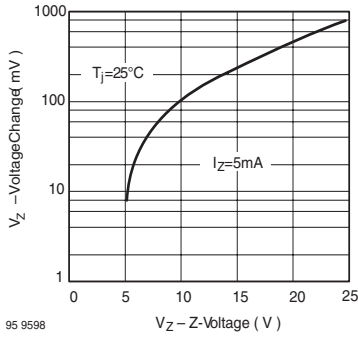
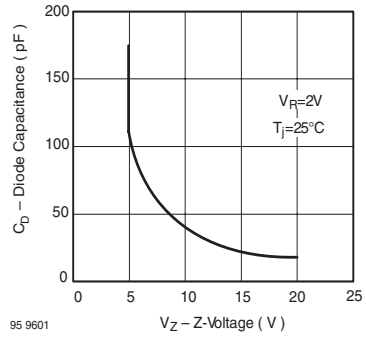

Figure 2. Total Power Dissipation vs. Ambient Temperature



95 9598

Figure 3. Typical Change of Working Voltage under Operating Conditions at  $T_{amb}=25^{\circ}\text{C}$



95 9601

Figure 6. Diode Capacitance vs. Z-Voltage

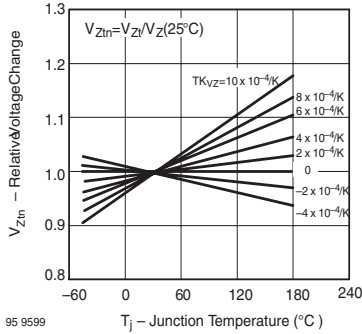

95 9599

Figure 4. Typical Change of Working Voltage vs. Junction Temperature

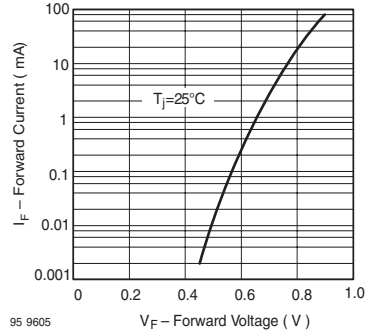

95 9605

Figure 7. Forward Current vs. Forward Voltage

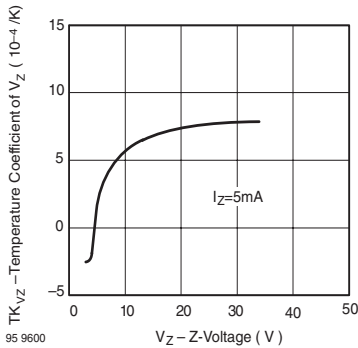

95 9600

Figure 5. Temperature Coefficient of  $V_Z$  vs. Z-Voltage

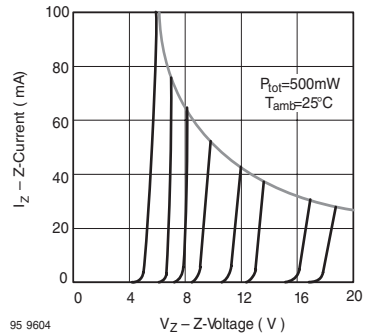

95 9604

Figure 8. Z-Current vs. Z-Voltage

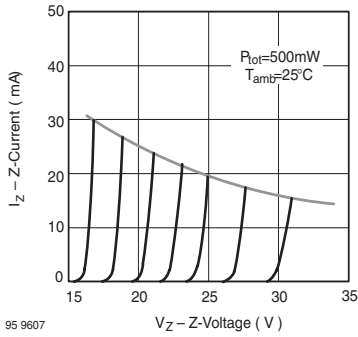

Figure 9. Z-Current vs. Z-Voltage

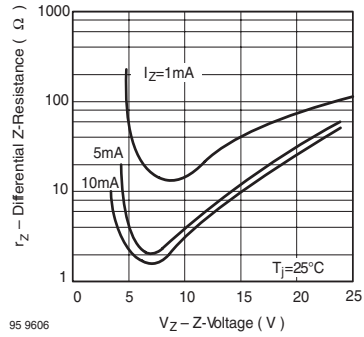

Figure 10. Differential Z-Resistance vs. Z-Voltage

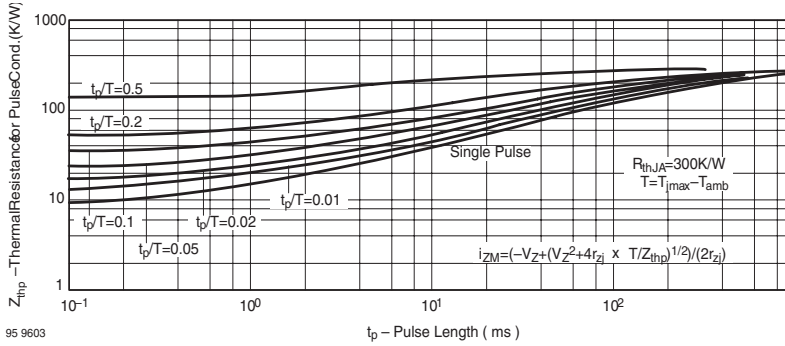

Figure 11. Thermal Response

**DO-35 Package Dimension**  
see Package Section



## Zener Diodes

### Features

- Plastic package has Underwriters Laboratory Flammability Classification 94 V-0
- Low Zener impedance
- Low regulation factor
- Glass passivated junction
- High temperature soldering guaranteed:  
260 °C/10 seconds 0.375 " (9.5 mm) lead length,  
5 lbs. (2.3 kg) tension

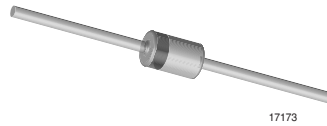

### Mechanical Data

**Case:** DO-41 Glass case

**Weight:** approx. 344 mg

**Packaging Codes/Options:**

TR / 5 k per 13 " reel (52 mm tape), 25 k/box

TAP / 5 k per Ammo mag. (52 mm tape), 25 k/box

### Absolute Maximum Ratings

$T_{amb} = 25\text{ }^{\circ}\text{C}$ , unless otherwise specified

Parameter	Test condition	Symbol	Value	Unit
Operating junction and storage temperature range		$T_j, T_{stg}$	- 55 to + 150	$^{\circ}\text{C}$



# Z4KE100 to Z4KE200A



Vishay Semiconductors

## Electrical Characteristics

$T_{amb} = 25\text{ }^{\circ}\text{C}$  unless otherwise noted

Partnumber	Zener Voltage		Maximum Zener dynamic impedance		Test Current		Maximum DC Reverse Leakage Current $V_R$			Maximum Instantaneous Forward Voltage at 0.50 A	Maximum Continuous Regulator Current <sup>1)</sup>
	$V_Z @ I_{ZT}$		$Z_{ZT}$	$Z_{ZK}$	$I_{ZT}$	$I_{ZK}$	$V_R$	$I_R @ 25\text{ }^{\circ}\text{C}$	$I_R 100\text{ }^{\circ}\text{C}$	$V_{FM}$	$I_{ZM}$
	V	V	$\Omega$	$\Omega$	mA	mA	V	$\mu\text{A}$	$\mu\text{A}$	V	mA
	min	max									
Z4KE100	90	110	500	5000	5	0.25	72	0.5	100	1	15
Z4KE100A	95	105	500	5000	5	0.25	76	0.5	100	1	15
Z4KE110	99	121	600	5000	5	0.25	79.2	0.5	100	1	13
Z4KE110A	104	116	600	5000	5	0.25	83.2	0.5	100	1	13
Z4KE120	108	132	700	5000	5	0.25	86.4	0.5	100	1	12
Z4KE120A	114	126	700	5000	5	0.25	91.2	0.5	100	1	12
Z4KE130	117	143	800	5000	5	0.25	93.6	0.5	100	1	11
Z4KE130A	124	137	800	5000	5	0.25	99.2	0.5	100	1	11
Z4KE140	126	154	900	5000	5	0.25	100	0.5	100	1	10.7
Z4KE140A	133	147	900	5500	5	0.25	106.4	0.5	100	1	10.7
Z4KE150	135	165	1000	6000	5	0.25	108	0.5	100	1	10
Z4KE150A	142	158	1000	6000	5	0.25	113.6	0.5	100	1	10
Z4KE160	144	176	1100	6500	5	0.25	115.2	0.5	100	1	9
Z4KE160A	152	168	1100	6500	5	0.25	121.6	0.5	100	1	9
Z4KE170	153	187	1200	7000	5	0.25	122.4	0.5	100	1	8.8
Z4KE170A	162	179	1200	7000	5	0.25	129.6	0.5	100	1	8
Z4KE180	162	198	1300	7000	5	0.25	129.6	0.5	100	1	8
Z4KE180A	171	189	1300	7000	5	0.25	136.8	0.5	100	1	8
Z4KE190	171	209	1400	7500	5	0.25	136.8	0.5	100	1	7.9
Z4KE190A	180	200	1400	7500	5	0.25	144	0.5	100	1	7.9
Z4KE200	180	220	1500	8000	5	0.25	144	0.5	100	1	7
Z4KE200A	190	210	1500	8000	5	0.25	152	0.5	100	1	7

<sup>1)</sup> Standard voltage tolerance is  $\pm 10\%$ , suffix "A" is  $\pm 5\%$

<sup>2)</sup> Temperature rating at specified regulator current is  $T_L = 30\text{ }^{\circ}\text{C}$

<sup>3)</sup> Maximum steady state power dissipation is 1.5 watts at  $T_L = 75\text{ }^{\circ}\text{C}$  with lead length 0.375" (9.5 mm)

## Typical Characteristics ( $T_{amb} = 25\text{ }^{\circ}\text{C}$ unless otherwise specified)

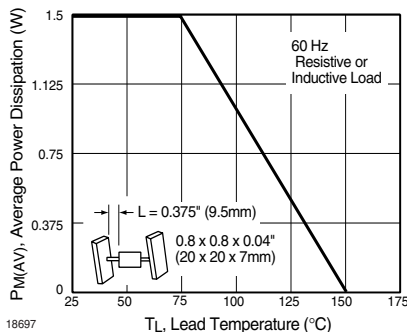

Figure 1. Maximum Continuous Power Dissipation

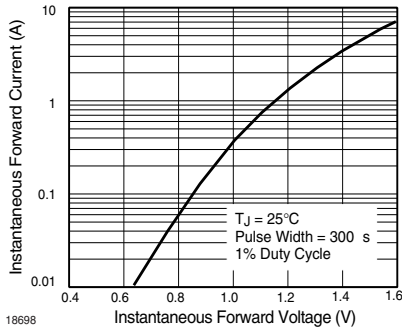

Figure 2. Typical Instantaneous Forward Characteristics

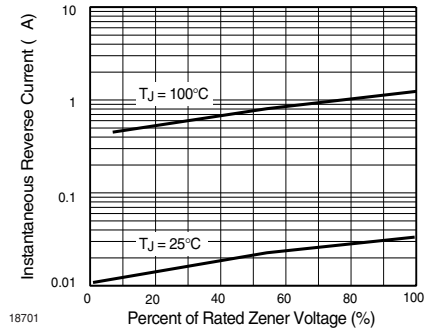

Figure 5. Typical Reverse Characteristics

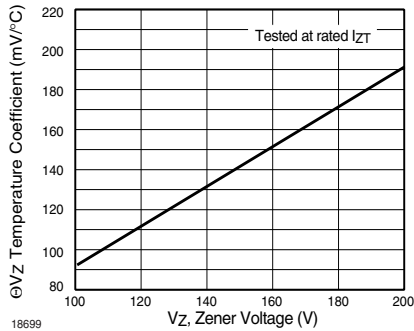

Figure 3. Typical Temperature Coefficients

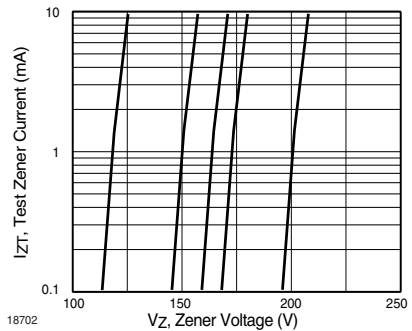

Figure 6. Typical Zener Voltage

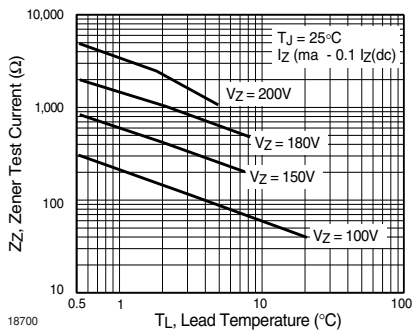

Figure 4. Typical Zener Impedance

**DO-41 Glass Package Dimension  
see Package Section**

# Z4KE100 to Z4KE200A

Vishay Semiconductors

---



## Zener Diodes

### Features

- Silicon Planar Power Zener Diodes.
- For use in stabilizing and clipping circuits with high power rating.
- Standard Zener voltage tolerance is  $\pm 5\%$ .
- These diodes are also available in the DO-41 case with type designation 1N4728 A... 1N4764A

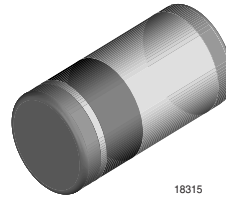

18315

### Mechanical Data

**Case:** MELF Glass case

**Weight:** approx. 135 mg

### Packaging Codes/Options:

GS18 / 10 k per 13" reel (8 mm tape), 10 k/box

GS08 / 3 k per 13" reel (8 mm tape), 15 k/box

### Absolute Maximum Ratings

$T_{amb} = 25\text{ }^{\circ}\text{C}$ , unless otherwise specified

Parameter	Test condition	Symbol	Value	Unit
Zener current (see Table "Characteristics")				
Power dissipation		$P_{tot}$	1.0 <sup>1)</sup>	W

<sup>1)</sup> Valid provided that electrodes are kept at ambient temperature.

### Thermal Characteristics

$T_{amb} = 25\text{ }^{\circ}\text{C}$ , unless otherwise specified

Parameter	Test condition	Symbol	Value	Unit
Thermal resistance junction to ambient air		$R_{thJA}$	170 <sup>1)</sup>	$^{\circ}\text{C}/\text{W}$
Junction temperature		$T_j$	150	$^{\circ}\text{C}$
Storage temperature		$T_s$	- 65 to + 150	$^{\circ}\text{C}$

<sup>1)</sup> Valid provided that electrodes are kept at ambient temperature.

# ZM4728A to ZM4764A



Vishay Semiconductors

## Electrical Characteristics

Partnumber	Nominal Zener Voltage <sup>3)</sup>	Test Current	Maximum Zener Impedance <sup>1)</sup>			Maximum Reverse Leakage Current		Surge current	Maximum Reverse Leakage Current <sup>2)</sup>				
			$V_Z @ I_{ZT}$	$I_{ZT}$	$Z_{ZT} @ I_{ZT}$	$Z_{ZK} @ I_{ZK}$	$I_{ZK}$			$I_R$	$V_R$	$I_R @ T_{amb} = 25\text{ }^\circ\text{C}$	$I_{ZM}$
			V	mA	$\Omega$		mA			$\mu\text{A}$	V	mA	$\mu\text{A}$
ZM4728A	3.3	76	10	400	1	100	1	1380	276				
ZM4729A	3.6	69	10	400	1	100	1	1260	252				
ZM4730A	3.9	64	9	400	1	50	1	1190	234				
ZM4731A	4.3	58	9	400	1	10	1	1070	217				
ZM4732A	4.7	53	8	500	1	10	1	970	193				
ZM4733A	5.1	49	7	550	1	10	1	890	178				
ZM4734A	5.6	45	5	600	1	10	2	810	162				
ZM4735A	6.2	41	2	700	1	10	3	730	146				
ZM4736A	6.8	37	3.5	700	1	10	4	660	133				
ZM4737A	7.5	34	4	700	0.5	10	5	605	121				
ZM4738A	8.2	31	4.5	700	0.5	10	6	550	110				
ZM4739A	9.1	28	5	700	0.5	10	7	500	100				
ZM4740A	10	25	7	700	0.25	10	7.6	454	91				
ZM4741A	11	23	8	700	0.25	5	8.4	414	83				
ZM4742A	12	21	9	700	0.25	5	9.1	380	76				
ZM4743A	13	19	10	700	0.25	5	9.9	344	69				
ZM4744A	15	17	14	700	0.25	5	11.4	304	61				
ZM4745A	16	15.5	16	700	0.25	5	12.2	285	57				
ZM4746A	18	14	20	750	0.25	5	13.7	250	50				
ZM4747A	20	12.5	22	750	0.25	5	15.2	225	45				
ZM4748A	22	11.5	23	750	0.25	5	16.7	205	41				
ZM4749A	24	10.5	25	750	0.25	5	18.2	190	38				
ZM4750A	27	9.5	35	750	0.25	5	20.6	170	34				
ZM4751A	30	8.5	40	1000	0.25	5	22.8	150	30				
ZM4752A	33	7.5	45	1000	0.25	5	25.1	135	27				
ZM4753A	36	7	50	1000	0.25	5	27.4	125	25				
ZM4754A	39	6.5	60	1000	0.25	5	29.7	115	23				
ZM4755A	43	6	70	1500	0.25	5	32.7	110	22				
ZM4756A	47	5.5	80	1500	0.25	5	35.8	95	19				
ZM4757A	51	5	95	1500	0.25	5	38.8	90	18				
ZM4758A	56	4.5	110	2000	0.25	5	42.6	80	16				
ZM4759A	62	4	125	2000	0.25	5	47.1	70	14				
ZM4760A	68	3.7	150	2000	0.25	5	51.7	65	13				
ZM4761A	75	3.3	175	2000	0.25	5	56	60	12				
ZM4762A	82	3	200	3000	0.25	5	62.2	55	11				
ZM4763A	91	2.8	250	3000	0.25	5	69.2	50	10				
ZM4764A	100	2.5	350	3000	0.25	5	76	45	9				

<sup>1)</sup> The Zener impedance is derived from the 1KHz AC voltage which results when an AC current having an RMS value equal to 10 % of the Zener current ( $I_{ZT}$  or  $I_{ZK}$ ) is superimposed on  $I_{ZT}$  or  $I_{ZK}$ . Zener impedance is measured at two points to insure a sharp knee on the breakdown curve and to eliminate unstable units

<sup>2)</sup> Valid provided that electrodes at a distance of 10 mm from case are kept at ambient temperature

<sup>3)</sup> Measured under thermal equilibrium and DC test conditions.

## Typical Characteristics ( $T_{amb} = 25\text{ }^{\circ}\text{C}$ unless otherwise specified)

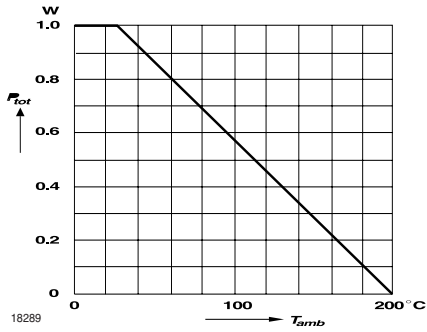

Figure 1. Admissible Power Dissipation vs. Ambient Temperature

**MELF Glass Package Dimension**  
see Package Section

# ZM4728A to ZM4764A

Vishay Semiconductors

---



## Zener Diodes

### Features

- Silicon Planar Power Zener Diodes.
- For use in stabilizing and clipping circuits with high power rating.
- The Zener voltages are graded according to the international E 24 standard. Smaller voltage tolerances are available upon request.
- These diodes are also available in the DO-41 case with the type designation ZPU100 ... ZPU180.

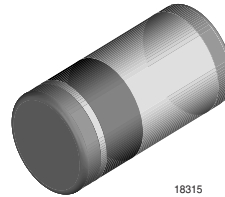

### Mechanical Data

**Case:** MELF Glass case

**Weight:** approx. 135 mg

### Packaging Codes/Options:

GS18/ 10 k per 13 " reel (12 mm tape), 10 k/box

GS08/ 3 k per 7 " reel (12 mm tape), 15 k/box

### Absolute Maximum Ratings

$T_{amb} = 25\text{ }^{\circ}\text{C}$ , unless otherwise specified

Parameter	Test condition	Symbol	Value	Unit
Zener current (see table "Characteristics")				
Power dissipation	$T_{amb} = 25\text{ }^{\circ}\text{C}$	$P_{tot}$	1.0 <sup>1)</sup>	W

<sup>1)</sup> Valid provided that electrodes are kept at ambient temperature.

### Thermal Characteristics

$T_{amb} = 25\text{ }^{\circ}\text{C}$ , unless otherwise specified

Parameter	Test condition	Symbol	Value	Unit
Thermal resistance junction to ambient air		$R_{thJA}$	170 <sup>1)</sup>	$^{\circ}\text{C/W}$
Junction temperature		$T_j$	150	$^{\circ}\text{C}$
Storage temperature range		$T_S$	- 55 to + 150	$^{\circ}\text{C}$

<sup>1)</sup> Valid provided that electrodes are kept at ambient temperature.



### Electrical Characteristics

Partnumber	Zener Voltage <sup>1)</sup>		Dynamic Resistance		Test Current	Temperature Coefficient of Zener Voltage		Reverse Voltage	Admissible Zener Current <sup>2)</sup>	
	$V_Z @ I_{ZT}$		$r_{zj} @ I_{ZT}, f = 1 \text{ kHz}$			$I_{ZT}$	$a_{VZ} @ I_{ZT}$			
	V	V	$\Omega$	$\Omega$		mA	$10^{-4}/^{\circ}\text{C}$			
	min	max	typ	max		min	max	V	mA	
ZMU100	88	110	140	< 300	5	+ 9	+ 13	> 75	7	
ZMU120	107	134	170	< 330	5	+ 9	+ 13	> 90	6	
ZMU150	130	165	200	< 360	5	+ 9	+ 13	> 112	5	
ZMU180	160	200	220	< 380	5	+ 9	+ 13	> 134	4	

<sup>1)</sup> Tested with pulses  $t_p = 5 \text{ ms}$

<sup>2)</sup> Valid provided that electrodes are kept at ambient temperature

### Typical Characteristics ( $T_{amb} = 25^{\circ}\text{C}$ unless otherwise specified)

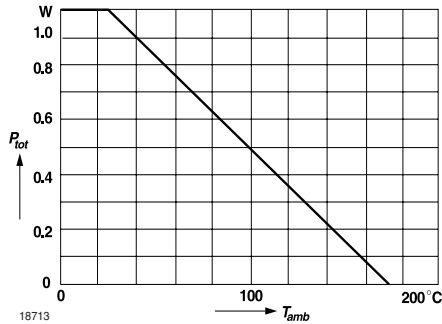

Figure 1. Admissible Power Dissipation vs. Ambient Temperature

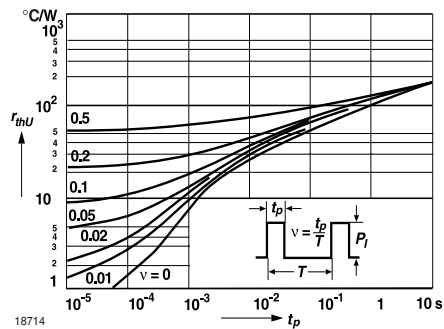

Figure 2. Pulse Thermal Resistance vs. Pulse Duration

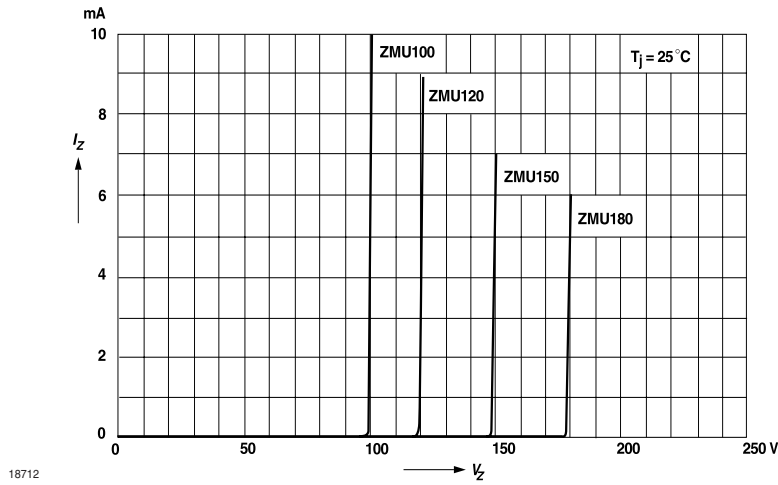

Figure 3. Breakdown Characteristics

**MELF Glass Package Dimension**  
see Package Section

# ZMU100 to ZMU180

Vishay Semiconductors

---



## Zener Diodes

### Features

- Silicon Planar Power Zener Diodes.
- For use in stabilizing and clipping circuits with high power rating.
- The Zener voltages are graded according to the international E 24 standard. Smaller voltage tolerances are available upon request.
- These diodes are also available in the DO-41 case with the type designation ZPY1 ... ZPY100.

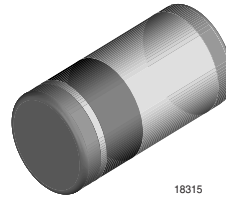

### Mechanical Data

**Case:** MELF Glass case

**Weight:** approx. 135 mg

### Packaging Codes/Options:

GS18/ 10 k per 13 " reel (12 mm tape), 10 k/box

GS08/ 3 k per 7 " reel (12 mm tape), 15 k/box

### Absolute Maximum Ratings

$T_{amb} = 25\text{ }^{\circ}\text{C}$ , unless otherwise specified

Parameter	Test condition	Symbol	Value	Unit
Zener current (see Table "Characteristics")				
Power dissipation		$P_{tot}$	1.0 <sup>1)</sup>	W

<sup>1)</sup> Valid provided that electrodes are kept at ambient temperature.

### Thermal Characteristics

$T_{amb} = 25\text{ }^{\circ}\text{C}$ , unless otherwise specified

Parameter	Test condition	Symbol	Value	Unit
Thermal resistance junction to ambient (max.)		$R_{thJA}$	170 <sup>1)</sup>	$^{\circ}\text{C}/\text{W}$
Thermal resistance junction to case (typ.)		$R_{thJC}$	60	$^{\circ}\text{C}/\text{W}$
Junction temperature		$T_j$	175	$^{\circ}\text{C}$
Storage temperature		$T_S$	- 55 to + 175	$^{\circ}\text{C}$

<sup>1)</sup> Valid provided that electrodes are kept at ambient temperature.

### Electrical Characteristics

Partnumber	Zener Voltage (2)		Dynamic Resistance		Temperature Coefficient of Zener Voltage		Test Current	Reverse Voltage	Admissible Zener Current (1)
	$V_Z @ I_{ZT}$		$r_{zj} @ I_{ZT}, f = 1 \text{ kHz}$		$\alpha_{VZ} @ I_{ZT}$				
	V		$\Omega$		$10^{-4}/^{\circ}\text{C}$		mA	V	mA
	min	max	typ	min	max				
ZMY3V9	3.7	4.1	7	4	-7	2	100	-	203
ZMY4V3	4	4.6	7	4	-7	3	100	-	182
ZMY4V7	4.4	5	7	4	-7	4	100	-	165
ZMY5V1	4.8	5.4	5	2	-6	5	100	0.7	150
ZMY5V6	5.2	6	2	1	-3	5	100	1.5	135
ZMY6V2	5.8	6.6	2	1	-1	6	100	2	128
ZMY6V8	6.4	7.2	2	1	0	7	100	3	110
ZMY7V5	7	7.9	2	1	0	7	100	5	100
ZMY8V2	7.7	8.7	2	1	3	8	100	6	89
ZMY9V1	8.5	9.6	4	2	3	8	50	7	82
ZMY10	9.4	10.6	4	2	5	9	50	7.5	74
ZMY11	10.4	11.6	7	3	5	10	50	8.5	66
ZMY12	11.4	12.7	7	3	5	10	50	9	60
ZMY13	12.4	14.1	9	4	5	10	50	10	55
ZMY15	13.8	15.8	9	4	5	10	50	11	49
ZMY16	15.3	17.1	10	5	7	11	25	12	44
ZMY18	16.8	19.1	11	5	7	11	25	14	40
ZMY20	18.8	21.2	12	6	7	11	25	15	36
ZMY22	20.8	23.3	13	7	7	11	25	17	34
ZMY24	22.8	25.6	14	8	7	12	25	18	29
ZMY27	25.1	28.9	15	9	7	12	25	20	27
ZMY30	28	32	20	10	7	12	25	22.5	25
ZMY33	31	35	20	11	7	12	25	25	22
ZMY36	34	38	60	25	7	12	10	27	20
ZMY39	37	41	60	30	8	12	10	29	18
ZMY43	40	46	80	35	8	13	10	32	17
ZMY47	44	50	80	40	8	13	10	35	15
ZMY51	48	54	100	45	8	13	10	38	14
ZMY56	52	60	100	50	8	13	10	42	13
ZMY62	58	66	130	60	8	13	10	47	11
ZMY68	64	72	130	65	8	13	10	51	10
ZMY75	70	79	160	70	8	13	10	56	9
ZMY82	77	88	160	80	8	13	10	61	8
ZMY91	85	96	250	120	9	13	5	68	7.5
ZMY100	94	106	250	130	9	13	5	75	7

1) Valid provided that electrodes are kept at ambient temperature

2) Tested with pulses  $t_p = 5 \text{ ms}$

The ZMY1 is a silicon diode operated in forward direction. Hence, the index of all characteristics and maximum ratings should be "F" instead of "Z". Connect the cathode terminal to the negative pole. For devices in glass case MELF with higher Zener voltage but same power dissipation see types ZMU100 ... ZMU180

## Typical Characteristics ( $T_{amb} = 25^\circ\text{C}$ unless otherwise specified)

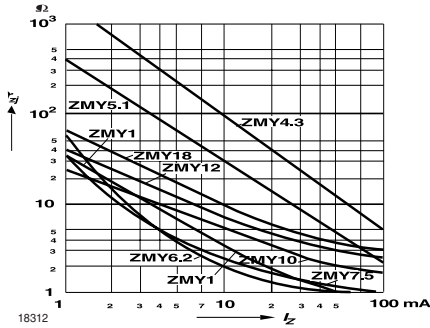

Figure 1. Dynamic Resistance vs. Zener Current

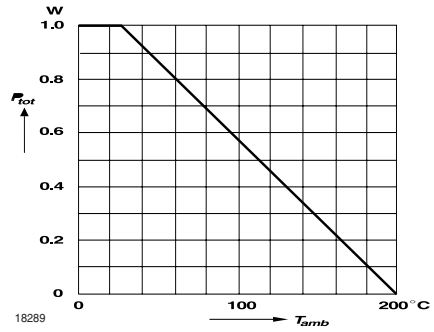

Figure 4. Admissible Power Dissipation vs. Ambient Temperature

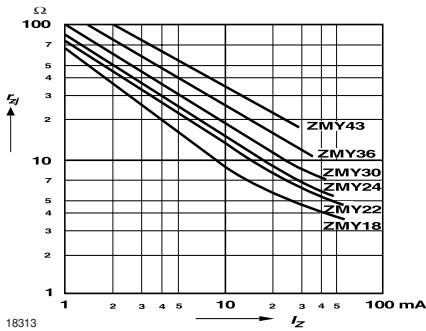

Figure 2. Dynamic Resistance vs. Zener Current

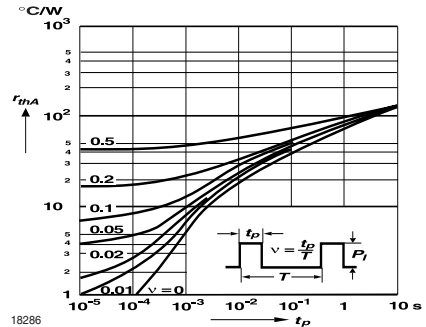

Figure 5. Pulse Thermal Resistance vs. Pulse Duration

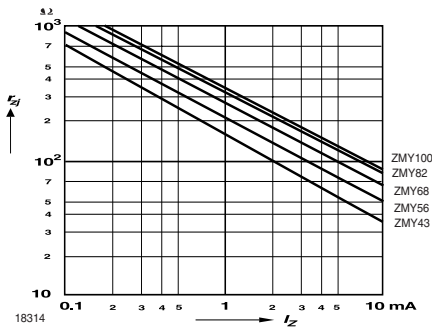
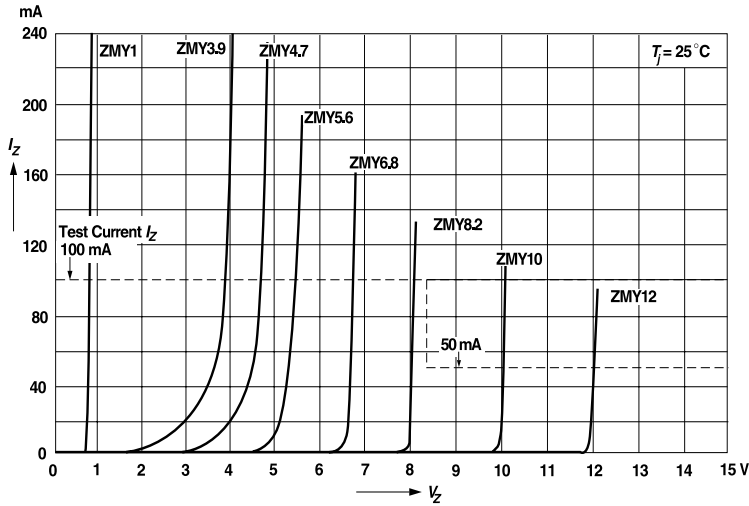
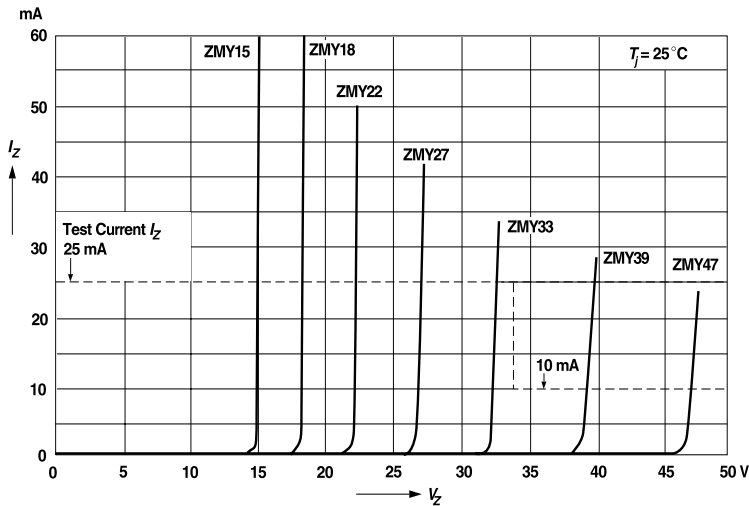

Figure 3. Dynamic Resistance vs. Zener Current



18309

Figure 6. Breakdown Characteristics



18310

Figure 7. Breakdown Characteristics

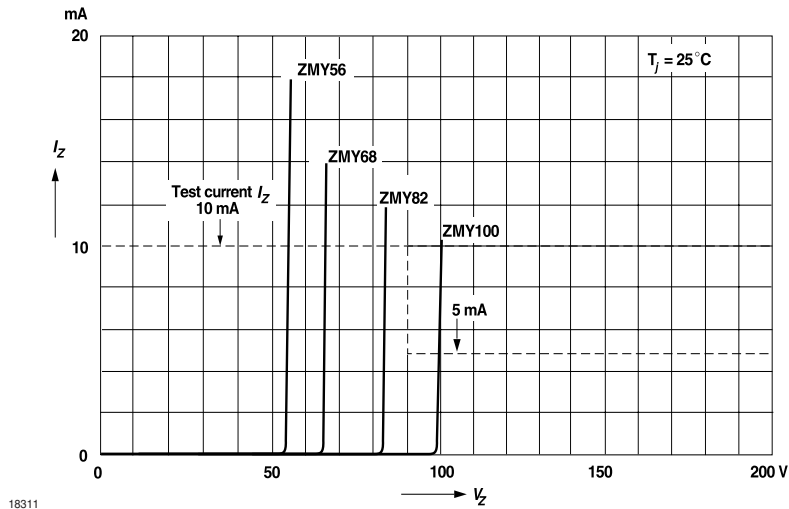

Figure 8. Breakdown Characteristics

**MELF Glass Package Dimension**  
see Package Section



# ZMY3V9 to ZMY100

Vishay Semiconductors

---



## Zener Diodes

### Features

- Silicon Planar Zener Diodes
- For use in stabilizing and clipping circuits with high power rating.
- The Zener voltages are graded according to the international E 12 standard. Smaller voltage tolerances are available upon request.
- These diodes are also available in the MELF case with the type designation ZMU100 ... ZMU180.

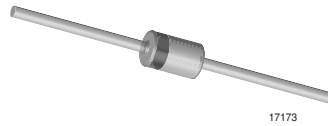

### Mechanical Data

**Case:** DO-41 Glass case

**Weight:** approx. 310 mg

**Packaging Codes/Options:**

TR / 5 k per 13 " reel (52 mm tape), 25 k/box

TAP / 5 k per Ammo mag. (52 mm tape), 25 k/box

### Absolute Maximum Ratings

$T_{amb} = 25\text{ }^{\circ}\text{C}$ , unless otherwise specified

Parameter	Test condition	Symbol	Value	Unit
Zener current (see Table "Characteristics")				
Power dissipation		$P_{tot}$	1.3 <sup>1)</sup>	W

<sup>1)</sup> Valid provided that leads at a distance of 10 mm from case are kept at ambient temperature.

### Thermal Characteristics

$T_{amb} = 25\text{ }^{\circ}\text{C}$ , unless otherwise specified

Parameter	Test condition	Symbol	Value	Unit
Thermal resistance junction to ambient air		$R_{thJA}$	130 <sup>1)</sup>	$^{\circ}\text{C/W}$
Maximum junction temperature		$T_j$	175	$^{\circ}\text{C}$
Storage temperature range		$T_S$	- 55 to + 175	$^{\circ}\text{C}$

<sup>1)</sup> Valid provided that leads at a distance of 10 mm from case are kept at ambient temperature.

## Electrical Characteristics

Partnumber	Zener Voltage Range <sup>2)</sup>		Dynamic Resistance		Temperature Coefficient of Zener Voltage		Test Current	Reverse Voltage	Admissible Zener Current <sup>1)</sup>
	$V_Z @ I_{ZT}$		$r_{zj} @ I_{ZT}, f = 1 \text{ kHz}$		$\alpha_{VZ} @ I_{ZT}$		$I_{ZT}$	$V_R @ I_R = 0.5 \mu\text{A}$	$I_Z @ T_{\text{amb}}=25^\circ\text{C}$
	V		$\Omega$		$10^{-4}/^\circ\text{C}$		mA	V	mA
	min	max	typ	max	min	max		max	
ZPU100	88	110	140	300	9	13	5	75	10
ZPU120	107	134	170	330	9	13	5	90	8.5
ZPU150	130	165	200	360	9	13	5	112	7
ZPU180	160	200	220	380	9	13	5	134	5.5

<sup>1)</sup> Valid provided that leads are kept at ambient temperature at a distance of 10 mm from case

<sup>2)</sup> Tested with pulse  $t_p = 5 \text{ ms}$

## Typical Characteristics ( $T_{\text{amb}} = 25^\circ\text{C}$ unless otherwise specified)

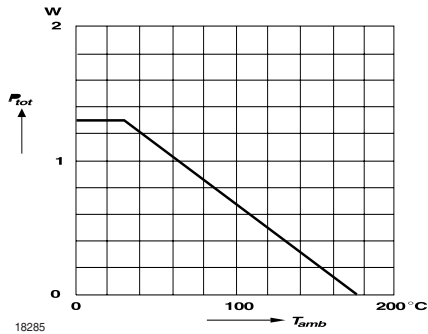

Figure 1. Admissible Power Dissipation vs. Ambient Temperature

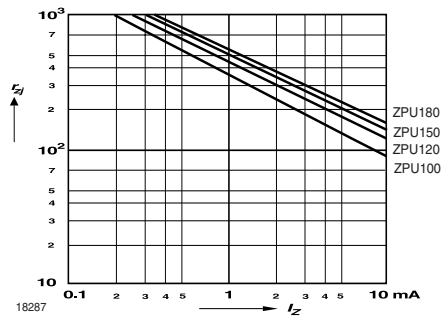

Figure 3. Dynamic Resistance vs. Zener Current

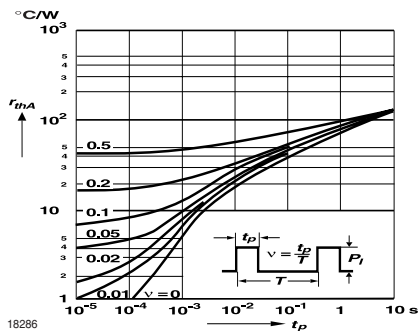

Figure 2. Pulse Thermal Resistance vs. Pulse Duration

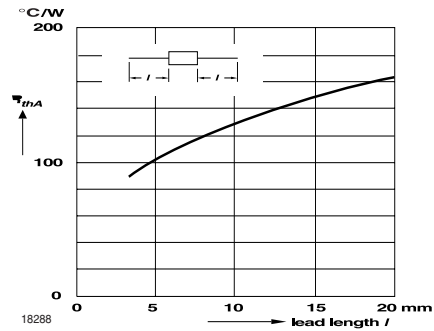

Figure 4. Thermal Resistance vs. Lead Length

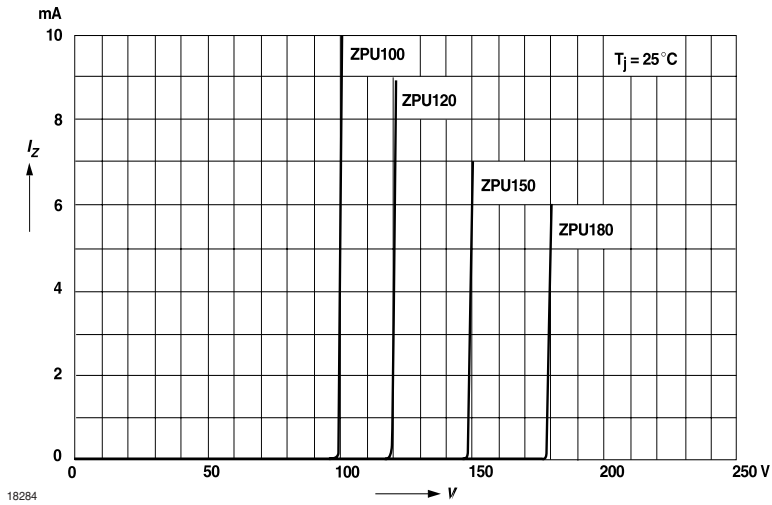

Figure 5. Breakdown Characteristics

**DO-41 Glass Package Dimension**  
see Package Section

# ZPU100 to ZPU180

Vishay Semiconductors

---



## Zener Diodes

### Features

- Silicon Planar Power Zener Diodes
- For use in stabilizing and clipping circuits with high power rating.
- The Zener voltages are graded according to the international E 12 standard. Smaller voltage tolerances are available upon request.
- These diodes are also available in the MELF case with the type designation ZMY10 ... ZMY110.

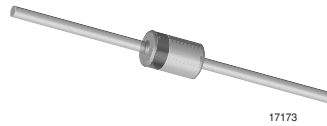

### Mechanical Data

**Case:** DO-41 Glass case

**Weight:** approx. 310 mg

**Packaging Codes/Options:**

TR / 5 k per 13 " reel (52 mm tape), 25 k/box

TAP / 5 k per Ammo mag. (52 mm tape), 25 k/box

### Absolute Maximum Ratings

$T_{amb} = 25\text{ }^{\circ}\text{C}$ , unless otherwise specified

Parameter	Test condition	Symbol	Value	Unit
Zener current (see Table "Characteristics")				
Power dissipation		$P_{tot}$	1.3 <sup>1)</sup>	W

<sup>1)</sup> Valid provided that leads at a distance of 10 mm from case are kept at ambient temperature.

### Thermal Characteristics

$T_{amb} = 25\text{ }^{\circ}\text{C}$ , unless otherwise specified

Parameter	Test condition	Symbol	Value	Unit
Thermal resistance junction to ambient air		$R_{thJA}$	130 <sup>1)</sup>	$^{\circ}\text{C/W}$
Maximum junction temperature		$T_j$	175	$^{\circ}\text{C}$
Storage temperature range		$T_S$	- 55 to + 175	$^{\circ}\text{C}$

<sup>1)</sup> Valid provided that leads at a distance of 10 mm from case are kept at ambient temperature.

# ZPY3V9 to ZPY110



Vishay Semiconductors

## Electrical Characteristics

Partnumber	Zener Voltage Range		Dynamic Resistance	Temperature Coefficient of Zener Voltage		Test Current	Reverse Voltage	Admissible Zener Current
	$V_Z @ I_{ZT}$		$r_{zj} @ I_{ZT1}$ , $f = 1 \text{ kHz}$	$TC_{VZ} @ I_{ZT}$		$I_{ZT}$	$V_R @ I_R = 0.5 \mu\text{A}$	$I_Z @ T_{amb} = 25 \text{ }^\circ\text{C}$
	V		$\Omega$	$10^{-4}/^\circ\text{C}$		mA	V	mA
	min	max	typ	min	max			
ZPY3V9	3.7	4.1	4 (< 7)	-7	2	100	-	290
ZPY4V3	4.0	4.6	4 (< 7)	-7	3	100	-	260
ZPY4V7	4.4	5.0	4 (< 7)	-7	4	100	-	235
ZPY5V1	4.8	5.4	2 (< 5)	-6	5	100	> 0.7	215
ZPY5V6	5.2	6.0	1 (< 2)	-3	5	100	> 1.5	193
ZPY6V2	5.8	6.6	1 (< 2)	-1	6	100	> 2.0	183
ZPY6V8	6.4	7.2	1 (< 2)	0	7	100	> 3.0	157
ZPY7V5	7.0	7.9	1 (< 2)	0	7	100	> 5.0	143
ZPY8V2	7.7	8.7	1 (< 2)	3	8	100	> 6.0	127
ZPY9V1	8.5	9.6	2 (< 4)	3	8	50	> 7.0	117
ZPY10	9.41	10.6	2 (< 4)	5	9	50	> 7.5	105
ZPY11	10.4	11.6	3 (< 7)	5	10	50	> 8.5	94
ZPY12	11.4	12.7	3 (< 7)	5	10	50	> 9.0	85
ZPY13	12.4	14.1	4 (< 9)	5	10	50	> 10	78
ZPY15	13.8	15.8	4 (< 9)	5	10	50	> 11	70
ZPY16	15.3	17.1	5 (< 10)	7	11	25	> 12	63
ZPY18	16.8	19.1	5 (< 11)	7	11	25	> 14	57
ZPY20	18.8	21.2	6 (< 12)	7	11	25	> 15	52
ZPY22	20.8	23.3	7 (< 13)	7	11	25	> 17	48
ZPY24	22.8	25.6	8 (< 14)	7	12	25	> 18	42
ZPY27	25.1	28.9	9 (< 15)	7	12	25	> 20	38
ZPY30	28	32	10 (< 20)	7	12	25	> 22.5	35
ZPY33	31	35	11 (< 20)	7	12	25	> 25	31
ZPY36	34	38	25 (< 60)	7	12	10	> 27	29
ZPY39	37	41	30 (< 60)	8	12	10	> 29	26
ZPY43	40	46	35 (< 80)	8	13	10	> 32	24
ZPY47	44	50	40 (< 80)	8	13	10	> 35	22
ZPY51	48	54	45 (< 100)	8	13	10	> 38	20
ZPY56	52	60	50 (< 100)	8	13	10	> 42	18
ZPY62	58	66	60 (< 130)	8	13	10	> 47	16
ZPY68	64	72	65 (< 130)	8	13	10	> 51	14
ZPY75	70	79	70 (< 160)	8	13	10	> 56	13
ZPY82	77	88	80 (< 160)	8	13	10	> 61	12
ZPY91	85	96	120 (< 250)	9	13	5	> 68	11
ZPY100	94	106	130 (< 250)	9	13	5	> 75	10
ZPY110	104	116	150 (< 250)	9	13	5	> 85	9

<sup>1)</sup> Valid provided that leads are kept at ambient temperature at a distance of 10 mm from case

<sup>2)</sup> Tested with pulses  $t_p = 5 \text{ ms}$

<sup>3)</sup> The ZPY1 is a silicon diode operated in forward direction. Hence, the index of all characteristics and maximum ratings should be "F" instead of "Z". Connect the cathode terminal to the negative pole

## Typical Characteristics ( $T_{amb} = 25^\circ\text{C}$ unless otherwise specified)

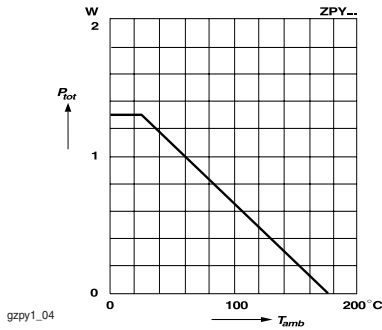

Figure 1. Admissible Power Dissipation vs. Ambient Temperature

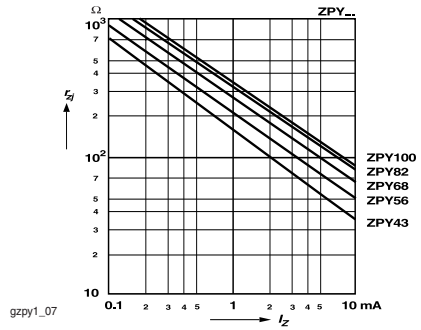

Figure 4. Dynamic Resistance vs. Zener Current

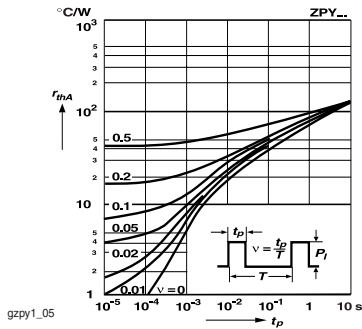

Figure 2. Pulse Thermal Resistance vs. Pulse Duration

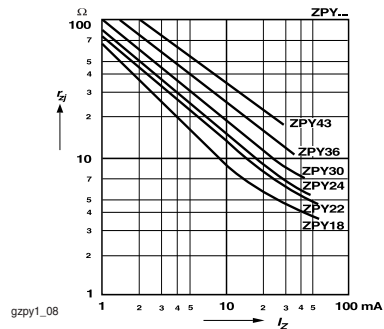

Figure 5. Dynamic Resistance vs. Zener Current

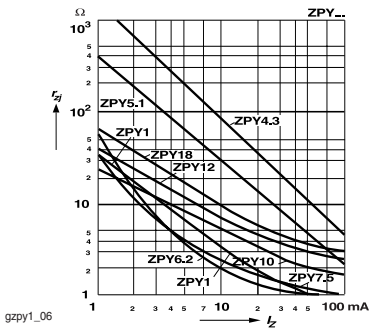

Figure 3. Dynamic Resistance vs. Zener Current

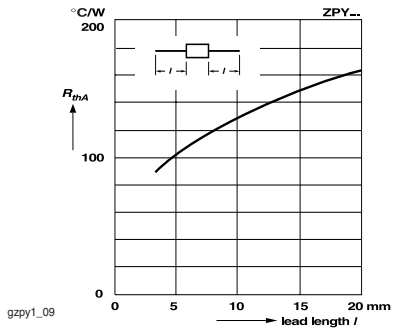
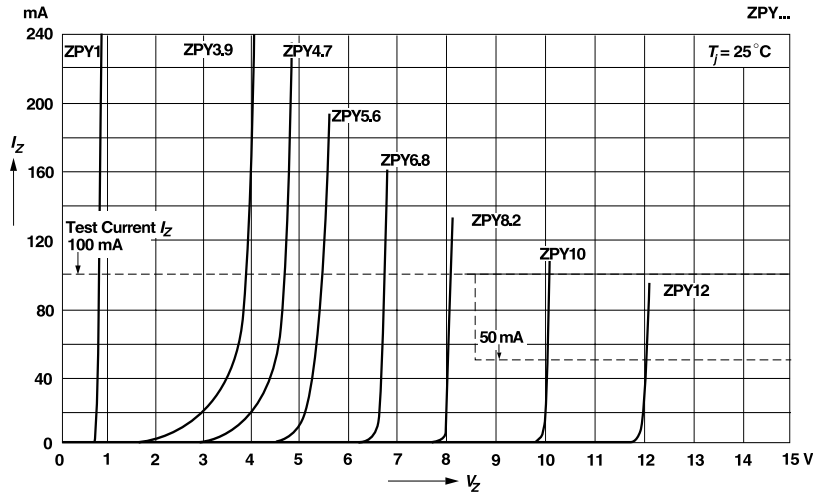

Figure 6. Thermal Resistance vs. Lead Length



# ZPY3V9 to ZPY110

Vishay Semiconductors



gzpy1\_01

Figure 7. Breakdown Characteristics

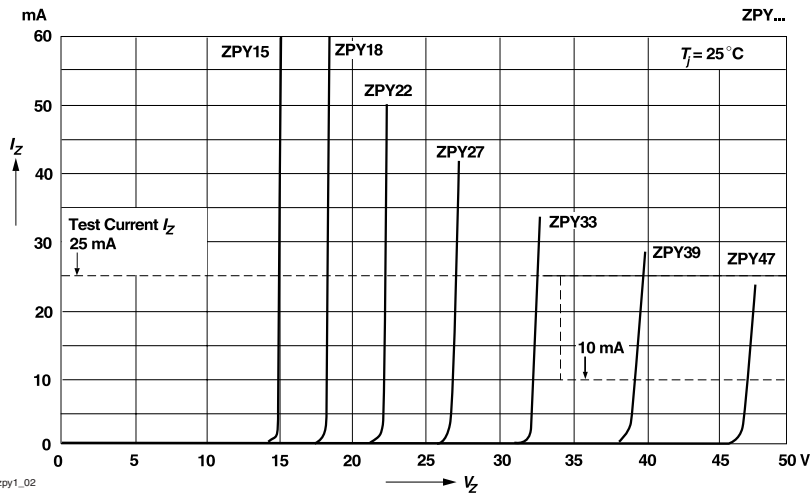

gzpy1\_02

Figure 8. Breakdown Characteristics

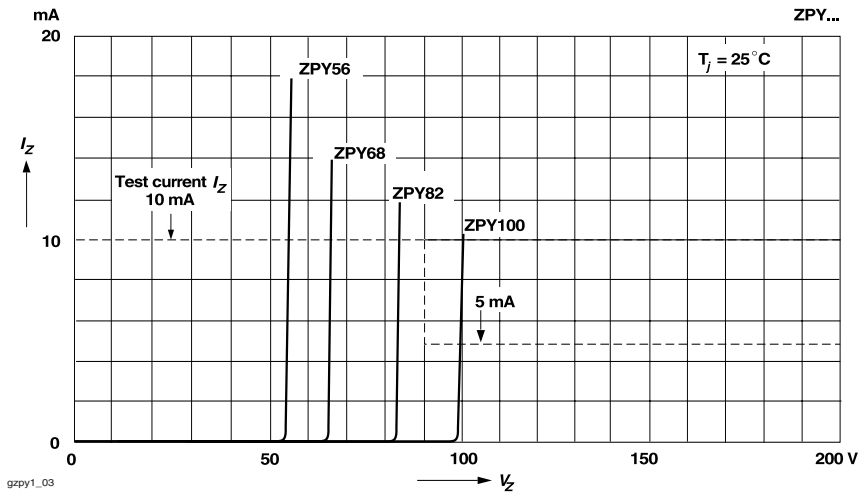

Figure 9. Breakdown Characteristics

**DO-41 Glass Package Dimension**  
 see Package Section

# ZPY3V9 to ZPY110

Vishay Semiconductors

---



**Selector Guides**



**General Information**



**Zener Datasheets**



**ESD Datasheets**

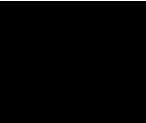

**Packages**



**Application Notes**



**Glossary**





## Low Capacitance ESD Protection Diode Array for High-Speed Data Interfaces

### Features

- Transient protection for data lines as per IEC 61000-4-2 (ESD) 15 kV (air) 8 kV (contact) IEC 61000-4-5 (Lightning) 12 A (tp = 8/ 20 μs)
- Small package for use in portable electronics
- Protects two I/O lines
- Low capacitance for high-speed data lines
- Low leakage current

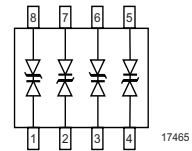
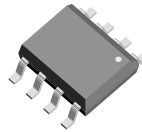

### Mechanical Data

**Case:** SO-8 molded plastic body

### Molding Compound Flammability Rating:

UL 94 V-0

**Terminals:** High temperature soldering guaranteed: 260 °C/10 sec. at terminals

**Weight:** approx. 500 mg

### Absolute Maximum Ratings

Ratings at 25 °C, ambient temperature unless otherwise specified

Parameter	Test condition	Symbol	Value	Unit
Peak pulse power	8/20 μs waveform	P <sub>PPM</sub>	300	W

### Thermal Characteristics

Ratings at 25 °C, ambient temperature unless otherwise specified

Parameter	Test condition	Symbol	Value	Unit
Operation temperature		T <sub>J</sub>	- 55 to + 125	°C
Storage temperature		T <sub>stg</sub>	- 55 to + 150	°C
Lead soldering temperature (10 sec)		T <sub>L</sub>	260	°C

### Electrical Characteristics

Ratings at 25 °C, ambient temperature unless otherwise specified

Parameter	Test condition	Symbol	Min	Typ.	Max	Unit
Reverse stand-off voltage		$V_{RWM}$			5	V
Reverse breakdown voltage	$I_t = 1 \text{ mA}$	$V_{BR}$	6			V
Reverse leakage current	$V_{RWM} = 5 \text{ V}$	$I_R$			20	$\mu\text{A}$
Clamping voltage	$I_{PP} = 5 \text{ A}, 8/20 \mu\text{s}$ waveform	$V_C$			11	V
	$I_{PP} = 1 \text{ A}, 8/20 \mu\text{s}$ waveform	$V_C$			9.8	V
Junction capacitance between I/O pins and GND	$V_R = 0 \text{ V}, f = 1 \text{ MHz}$	$C_j$			5	pF

### SO-8 Package Dimension see Package Section

## Low Capacitance Bidirectional ESD Protection Diodes

### Features

- Low capacitance
- Very low leakage current
- Bidirectional ESD protection
- ESD protection to **IEC 61000 - 4 - 2 Level 4**

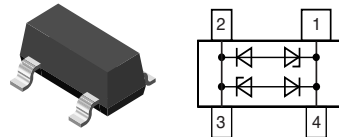

18909

### Mechanical Data

**Case:** SOT-143 Plastic case

**Weight:** approx. 8 mg

**Molding Compound Flammability Rating:**  
UL 94 V-0

**Terminals:** High temperature soldering guaranteed:  
260 °C/10 sec. at terminals

**Packaging:** TBD

**Packaging Codes/Options:**  
GS08 / 3 k per 7" reel (8 mm tape), 15 k/box

### Parts Table

Part	Ordering code	Marking	Remarks
GCDA15C-1	GCDA15C-1-GS08	GC1	Tape and Reel

### Absolute Maximum Ratings

Ratings at 25 °C, ambient temperature unless otherwise specified

Parameter	Test condition	Symbol	Value	Unit
Maximum Peak pulse current	8/20 $\mu$ s waveform	$I_{PPM}$	10	A
Peak pulse power	8/20 $\mu$ s waveform	$P_{PPM}$	350	W
ESD Air discharge per IEC 61000-4-2		$V_{PP}$	15	kV
ESD Contact discharge per IEC 61000-4-2		$V_{PP}$	8	kV

### Thermal Characteristics

Ratings at 25 °C, ambient temperature unless otherwise specified

Parameter	Test condition	Symbol	Value	Unit
Operation temperature		$T_J$	- 40 to + 125	°C
Storage temperature		$T_{STG}$	- 55 to + 150	°C



### Electrical Characteristics

Ratings at 25 °C, ambient temperature unless otherwise specified

Parameter	Test condition	Symbol	Min	Typ.	Max	Unit
Reverse stand-off voltage		$V_{RWM}$			15	V
Reverse breakdown voltage	$I_R = 1 \text{ mA}$	$V_{BR}$	16			V
Reverse leakage current	$V_{RW} = 15 \text{ V}$	$I_R$			100	$\mu\text{A}$
Capacitance	$V_R = 0 \text{ V}, f = 1 \text{ MHz}$	$C_D$		5		pF
Clamping voltage	$I_{PP} = 1 \text{ A}, 8/20 \mu\text{s}$ waveform (Fig. 4)	$V_C$			21	V
	$I_{PP} = 8 \text{ A}, 8/20 \mu\text{s}$ waveform (Fig. 4)	$V_C$			30	V

### Typical Characteristics ( $T_{amb} = 25 \text{ }^\circ\text{C}$ unless otherwise specified)

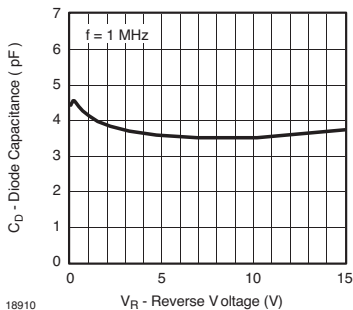

Figure 1. Typical Capacitance vs. Reverse Voltage

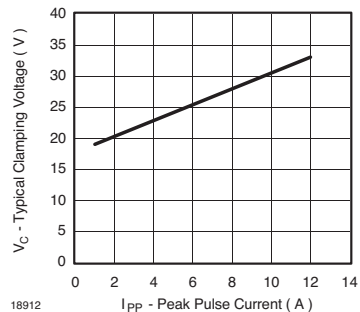

Figure 3. Typical Clamping Voltage vs. Peak Pulse Current

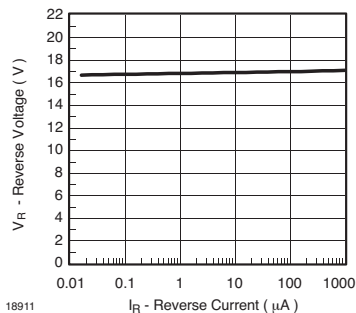

Figure 2. Typical Reverse Voltage vs. Reverse Current

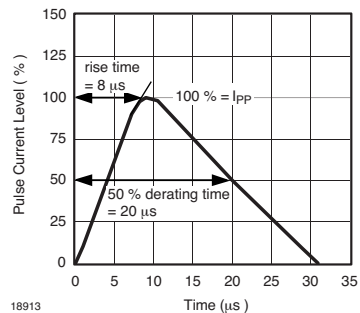

Figure 4. Pulse Waveform 8/20  $\mu\text{s}$  acc. IEC 61000 - 4 - 5

**SOT-143 Package Dimension**  
see Package Section

## Low Capacitance ESD Protection Diodes for High-Speed Data Interfaces

### Features

- Transient protection for data lines as per IEC 61000-4-2 (ESD) 15 kV (air) 8 kV (contact) IEC 61000-4-5 (Lightning) see  $I_{PPM}$  below
- Small package for use in portable electronics
- Low capacitance for high speed data lines, cellular handsets, USB port protection, LAN equipment, peripherals
- Space saving LLP package

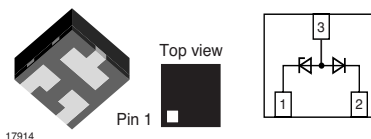

### Mechanical Data

**Case:** LLP75-3B Plastic case

**Molding Compound Flammability Rating:**

UL 94 V-0

**Terminals:** High temperature soldering guaranteed:  
260 °C/10 sec. at terminals

**Weight:** approx. 5.2 mg

### Parts Table

Part	Ordering code	Marking	Remarks
GL05-HT3	GL05-HT3-GS08	50	Tape and Reel
GL12-HT3	GL12-HT3-GS08	51	Tape and Reel
GL15-HT3	GL15-HT3-GS08	52	Tape and Reel
GL24-HT3	GL24-HT3-GS08	53	Tape and Reel

### Absolute Maximum Ratings

Ratings at 25 °C, ambient temperature unless otherwise specified

Parameter	Test condition	Symbol	Value	Unit
Peak pulse power	8/20 $\mu$ s waveform	$P_{PK}$	300	W
Peak repetitive reverse voltage (rectifier)		$V_{RRM}$	70	V
ESD voltage	ESD per IEC 61000-4-2	$V_{ESD}$	>25	kV

### Thermal Characteristics

Ratings at 25 °C, ambient temperature unless otherwise specified

Parameter	Test condition	Symbol	Value	Unit
Operation temperature		$T_J$	- 55 to + 125	°C
Storage temperature		$T_{stg}, T_{STG}$	- 55 to + 150	°C

# GL05-HT3 to GL24-HT3



Vishay Semiconductors

## Electrical Characteristic

Partnumber	Marking Code	$V_{RWM}$	$V_{BR(min)}$ @ $I_t = 1.0 \text{ mA}$	$I_{R(max)}$ @ $V_{RWM}$	$V_{C(max)}$		$I_{PPM}$ $t_p = 8/20 \mu\text{s}$	$C_j$ Pin1 to Pin2 Pin3 NC $V_R = 0\text{V}$ $f = 1 \text{ MHz}$
					$I_{PP = 1.0 \text{ A}}$	$I_{PP = 5.0 \text{ A}}$		
		V	V	$\mu\text{A}$	V	V	A	pF
GL05-HT3	50	5	6	20	9.8	11	17	5
GL12-HT3	51	12	13.3	1	19	24	12	5
GL15-HT3	52	15	16.7	1	24	33	10	5
GL24-HT3	53	24	26.7	1	43	55	5	5

**LLP75-3B Package Dimension**  
see Package Section

## Low Capacitance ESD Protection Diodes for High-Speed Data Interfaces

### Features

- Transient protection for data lines as per IEC 61000-4-2 (ESD) 15 kV (air) 8 kV (contact) IEC 61000-4-5 (Lightning) see  $I_{PPM}$  below
- Small package for use in portable electronics
- High temperature soldering guaranteed: 260 °C/ 10 sec. at terminals
- Low capacitance for high speed data lines, cellular handsets, USB port protection, LAN equipment, peripherals

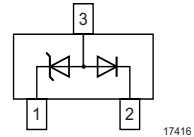
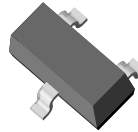

### Mechanical Data

**Case:** SOT-23 Plastic case

**Molding Compound Flammability Rating:**

UL 94 V-0

**Terminals:** High temperature soldering guaranteed:

260 °C/10 sec. at terminals

**Weight:** approx. 8.8 mg

### Absolute Maximum Ratings

Ratings at 25 °C, ambient temperature unless otherwise specified

Parameter	Test condition	Symbol	Value	Unit
Peak pulse power	8/20 $\mu$ s waveform	$P_{PK}$	300	W
Peak repetitive reverse voltage (rectifier)		$V_{RRM}$	70	V
ESD voltage	ESD per IEC 61000-4-2	$V_{ESD}$	>25	kV

### Thermal Characteristics

Ratings at 25 °C, ambient temperature unless otherwise specified

Parameter	Test condition	Symbol	Value	Unit
Operation temperature		$T_J$	- 55 to + 125	°C
Storage temperature		$T_{stg}$ , $T_{STG}$	- 55 to + 150	°C

# GL05T to GL24T



Vishay Semiconductors

## Electrical Characteristic

Partnumber	Marking Code	$V_{RWM}$	$V_{BR(min)}$ @ $I_t = 1.0 \text{ mA}$	$I_{R(max)}$ @ $V_{RWM}$	$V_{C(max)}$		$I_{PPM}$ $t_p = 8/20 \mu\text{s}$	$C_j$ Pin1 to Pin2 Pin3 NC $V_R = 0 \text{ V}$ $f = 1 \text{ MHz}$
					$I_{PP} = 1.0 \text{ A}$	$I_{PP} = 5.0 \text{ A}$		
		V	V	$\mu\text{A}$	V	V	A	pF
GL05T	L05	5	6	20	9.8	11	17	5
GL12T	L12	12	13.3	1	19	24	12	5
GL15T	L15	15	16.7	1	24	33	10	5
GL24T	L24	24	26.7	1	43	55	5	5

**SOT-23 Package Dimension**  
see Package Section

## ESD Protection Diode Array

### Features

- Transient protection for data lines as per IEC 61000-4-2 (ESD) 15 kV (air) 8 kV (contact) IEC 61000-4-5 (Lightning) 17 A (tp = 8/ 20  $\mu$ s)
- Protects four I/O lines
- Low leakage current

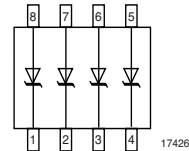
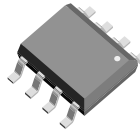

### Mechanical Data

**Case:** SO-8 molded plastic body

**Molding Compound Flammability Rating:**

UL 94 V-0

**Terminals:** High temperature soldering guaranteed:  
260 °C/10 sec. at terminals

**Weight:** approx. 500 mg

### Absolute Maximum Ratings

Ratings at 25 °C, ambient temperature unless otherwise specified

Parameter	Test condition	Symbol	Value	Unit
Peak pulse power	8/20 $\mu$ s waveform	$P_{PPM}$	300	W
Peak pulse current	8/20 $\mu$ s waveform	$I_{PP}$	17	A

### Thermal Characteristics

Ratings at 25 °C, ambient temperature unless otherwise specified

Parameter	Test condition	Symbol	Value	Unit
Operation temperature		$T_J$	- 55 to + 125	°C
Storage temperature		$T_{stg}$	- 55 to + 150	°C
Lead soldering temperature (10 sec)		$T_L$	260	°C

### Electrical Characteristics

Ratings at 25 °C, ambient temperature unless otherwise specified

Parameter	Test condition	Symbol	Min	Typ.	Max	Unit
Reverse stand-off voltage		$V_{RWM}$			5	V
Reverse breakdown voltage	$I_t = 1$ mA	$V_{BR}$	6			V
Reverse leakage current	$V_{RWM} = 5$ V	$I_R$			20	$\mu$ A
Clamping voltage	$I_{PP} = 1$ A, 8/20 $\mu$ s waveform	$V_C$			9.8	V
Junction capacitance	$V_R = 0$ V, $f = 1$ MHz	$C_j$			400	pF

**SO-8 Package Dimension**  
see Package Section



## ESD Protection Diode Array

### Features

- Transient protection for data lines as per IEC 61000-4-2 (ESD) 15 kV (air) 8 kV (contact) IEC 61000-4-5 (Lightning) 12 A (tp = 8/ 20 μs)
- Small SO-8 surface mount package
- 6-line unidirectional protection
- 5-line bidirectional protection
- Low leakage current

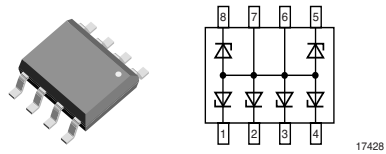

### Applications

RS-232 and RS-422 data lines

Microprocessor based equipment

LAN/ WAN equipment

Notebooks, desktops, servers

Portable instrumentation

Peripherals

Set-top box

### Mechanical Data

**Case:** SO-8 molded plastic body

**Terminals:** Leads solderable per MIL-STD-750, Method 2026

**Weight:** approx. 500 mg

### Connection for 5-line bidirectional protection

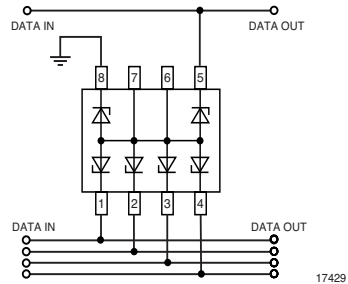

### Connection for 6-line unidirectional protection

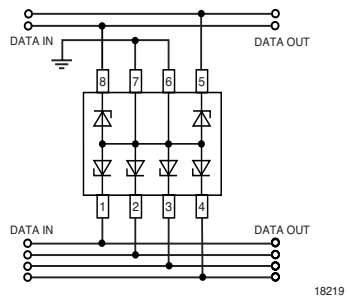



### Absolute Maximum Ratings

Ratings at 25 °C, ambient temperature unless otherwise specified

Parameter	Test condition	Symbol	Value	Unit
Peak pulse power	8/20 $\mu$ s waveform	$P_{PPM}$	300	W

### Thermal Characteristics

Ratings at 25 °C, ambient temperature unless otherwise specified

Parameter	Test condition	Symbol	Value	Unit
Operation temperature		$T_J$	- 55 to + 125	°C
Storage temperature		$T_{stg}$	- 55 to + 150	°C

### Electrical Characteristics

Ratings at 25 °C, ambient temperature unless otherwise specified

Parameter	Test condition	Symbol	Min	Typ.	Max	Unit
Reverse stand-off voltage		$V_{RWM}$			5	V
Reverse breakdown voltage	$I_t = 1$ mA	$V_{BR}$	6			V
Reverse leakage current	$V_{RWM} = 5$ V	$I_R$			20	$\mu$ A
Peak pulse current	8/20 $\mu$ s waveform	$I_{PPM}$			12	A
Clamping voltage	$I_{PP} = 1$ A, 8/20 $\mu$ s waveform	$V_C$			9.8	V
Junction capacitance between I/O pins and GND	$V_R = 0$ V, $f = 1$ MHz	$C_j$			400	pF

### SO-8 Package Dimension see Package Section

## ESD Protection Diode Array

### Features

- Transient protection for data lines as per IEC 61000-4-2 (ESD) 15 kV (air) 8 kV (contact) IEC 61000-4-5 (Lightning) 17 A (tp = 8/ 20 μs)
- Protects four I/O lines
- Low leakage current

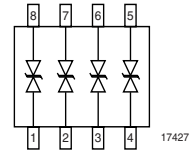
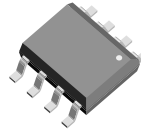

### Mechanical Data

**Case:** SO-8 molded plastic body

**Molding Compound Flammability Rating:**

UL 94 V-0

**Terminals:** High temperature soldering guaranteed:  
260 °C/10 sec. at terminals

**Weight:** approx. 500 mg

### Absolute Maximum Ratings

Ratings at 25 °C, ambient temperature unless otherwise specified

Parameter	Test condition	Symbol	Value	Unit
Peak pulse power	8/20 μs waveform	P <sub>PPM</sub>	300	W
Peak pulse current	8/20 μs waveform	I <sub>PP</sub>	17	A

### Thermal Characteristics

Ratings at 25 °C, ambient temperature unless otherwise specified

Parameter	Test condition	Symbol	Value	Unit
Operation temperature		T <sub>J</sub>	- 55 to + 125	°C
Storage temperature		T <sub>stg</sub>	- 55 to + 150	°C
Lead soldering temperature	10 sec	T <sub>L</sub>	260	°C

### Electrical Characteristics

Ratings at 25 °C, ambient temperature unless otherwise specified

Parameter	Test condition	Symbol	Min	Typ.	Max	Unit
Reverse stand-off voltage		V <sub>RWM</sub>			5	V
Reverse breakdown voltage	I <sub>t</sub> = 1 mA	V <sub>BR</sub>	6			V
Reverse leakage current	V <sub>RWM</sub> = 5 V	I <sub>R</sub>			20	μA
Clamping voltage	I <sub>PP</sub> = 1 A, 8/20 μs waveform	V <sub>C</sub>			9.8	V
Junction capacitance	V <sub>R</sub> = 0 V, f = 1 MHz	C <sub>j</sub>			400	pF

**SO-8 Package Dimension**  
see Package Section



## ESD Protection Diode Array

### Features

- Transient protection for data lines as per  
**IEC 61000 - 4 - 2 (ESD) 15 kV (air), 8 kV (contact)**  
**IEC 61000 - 4 - 5 (Lightning) 12 A (tp = 8/20  $\mu$ s)**
- Small package for use in portable electronics
- Bidirectional protection of 4 I/O lines
- Unidirectional protection of 5 I/O lines
- Low leakage current
- Ideal for cellular handsets, cordless phones, notebooks, handhelds and digital cameras

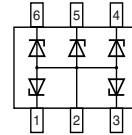
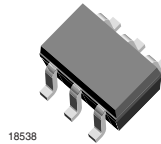

### Mechanical Data

**Case:** SOT-363 Plastic case

**Molding Compound Flammability Rating:**

UL 94 V-0

**Terminals:** High temperature soldering guaranteed:

260 °C/10 sec. at terminals

**Weight:** approx. 6.0 mg

### Parts Table

Part	Ordering code	Marking	Remarks
GMF05C	GMF05C-GS08	GM1	Tape and Reel

### Absolute Maximum Ratings

Ratings at 25 °C, ambient temperature unless otherwise specified

Parameter	Test condition	Symbol	Value	Unit
Peak pulse power	8/20 $\mu$ s waveform	$P_{ppm}$	200	W
Peak pulse current	8/20 $\mu$ s waveform	$I_{pp}$	12	A

### Thermal Characteristics

Ratings at 25 °C, ambient temperature unless otherwise specified

Parameter	Test condition	Symbol	Value	Unit
Operating temperature		$T_j$	- 55 to + 125	°C
Storage temperature		$T_{STG}$	- 55 to + 150	°C

### Electrical Characteristics

Ratings at 25 °C, ambient temperature unless otherwise specified

Parameter	Test condition	Symbol	Min	Typ.	Max	Unit
Reverse stand-off voltage		$V_{RWM}$			5	V
Reverse breakdown voltage	$I_t = 1 \text{ mA}$	$V_{BR}$	6			V
Reverse leakage current	$V_{RWM} = 5 \text{ V}$	$I_R$			1	$\mu\text{A}$
Clamping voltage	$I_{PP} = 1 \text{ A}$ , 8/20 $\mu\text{s}$ waveform	$V_C$			9.5	V
	$I_{PP} = 12 \text{ A}$ , 8/20 $\mu\text{s}$ waveform	$V_C$			12.5	V
Peak forward voltage	$I_F = 1 \text{ A}$ , 8/20 $\mu\text{s}$ waveform	$V_F$		1.5		V
Junction capacitance between I/O pins and Gnd	$V_R = 0 \text{ V}$ , $f = 1 \text{ MHz}$	$C_j$			150	pF

### Typical Characteristics ( $T_{amb} = 25 \text{ }^\circ\text{C}$ unless otherwise specified)

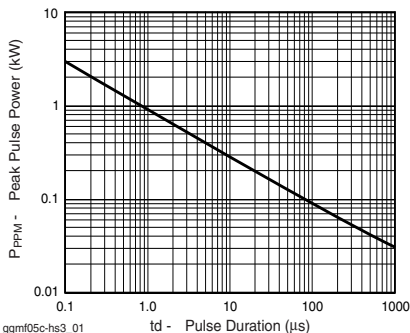

Figure 1. Non -Repetitive Peak Pulse Power vs. Pulse Time

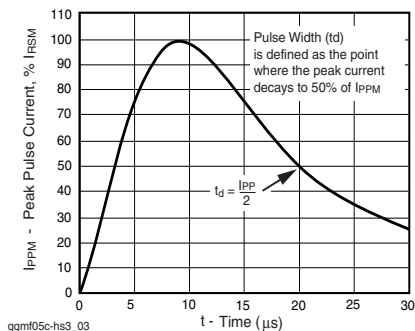

Figure 3. Pulse Waveform

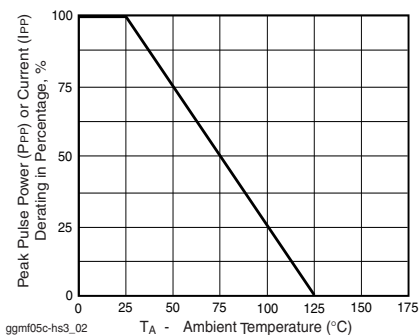

Figure 2. Pulse Derating Curve

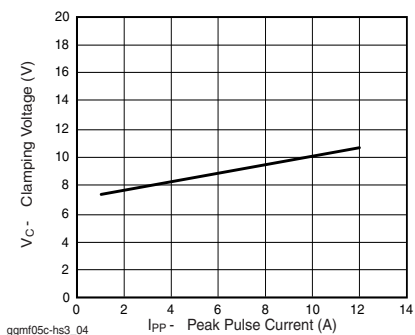

Figure 4. Clamping Voltage vs. Peak Pulse Current

**SOT-363 Package Dimension**  
see Package Section

## ESD Protection Diode Array

### Features

- Transient protection for data lines as per  
**IEC 61000 - 4 - 2 (ESD) 15 kV (air), 8 kV (contact)**  
**IEC 61000 - 4 - 5 (Lightning) 12 A (tp = 8/20  $\mu$ s)**
- Small package for use in portable electronics
- Bidirectional protection of 4 I/O lines
- Unidirectional protection of 5 I/O lines
- Low leakage current
- Ideal for cellular handsets, cordless phones, notebooks, handhelds and digital cameras
- Space saving LLP package

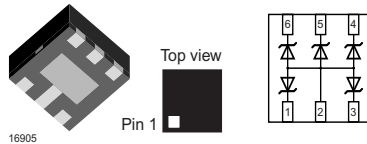

### Mechanical Data

**Case:** LLLP75-6A Plastic case

**Molding Compound Flammability Rating:**

UL 94 V-0

**Terminals:** High temperature soldering guaranteed:

260 °C/10 sec. at terminals

**Weight:** approx. 5.2 mg

### Parts Table

Part	Ordering code	Marking	Remarks
GMF05C-HS3	GMF05C-HS3-GS08	F5	Tape and Reel

### Absolute Maximum Ratings

Ratings at 25 °C, ambient temperature unless otherwise specified

Parameter	Test condition	Symbol	Value	Unit
Peak pulse power	8/20 $\mu$ s waveform	$P_{ppm}$	200	W
Peak pulse current	8/20 $\mu$ s waveform	$I_{pp}$	12	A

### Thermal Characteristics

Ratings at 25 °C, ambient temperature unless otherwise specified

Parameter	Test condition	Symbol	Value	Unit
Operating temperature		$T_j$	- 55 to + 125	°C
Storage temperature		$T_{STG}$	- 55 to + 150	°C

### Electrical Characteristics

Ratings at 25 °C, ambient temperature unless otherwise specified

Parameter	Test condition	Symbol	Min	Typ.	Max	Unit
Reverse stand-off voltage		$V_{RWM}$			5	V
Reverse breakdown voltage	$I_t = 1 \text{ mA}$	$V_{BR}$	6			V
Reverse leakage current	$V_{RWM} = 5 \text{ V}$	$I_R$			1.0	$\mu\text{A}$
Clamping voltage	$I_{PP} = 1 \text{ A}$ , 8/20 $\mu\text{s}$ waveform	$V_C$			9.5	V
	$I_{PP} = 12 \text{ A}$ , 8/20 $\mu\text{s}$ waveform	$V_C$			12.5	V
Peak forward voltage	$I_F = 1 \text{ A}$ , 8/20 $\mu\text{s}$ waveform	$V_F$		1.5		V
Junction capacitance between I/O pins and Gnd	$V_R = 0 \text{ V}$ , $f = 1 \text{ MHz}$	$C_j$			150	pF

### Typical Characteristics ( $T_{amb} = 25 \text{ }^\circ\text{C}$ unless otherwise specified)

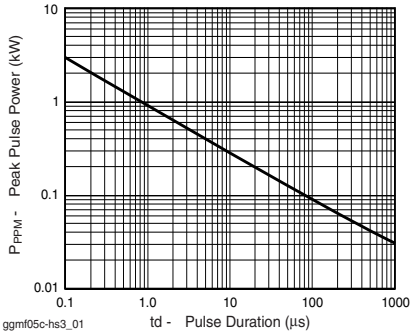

Figure 1. Non-Repitive Peak Pulse Power vs. Pulse Time

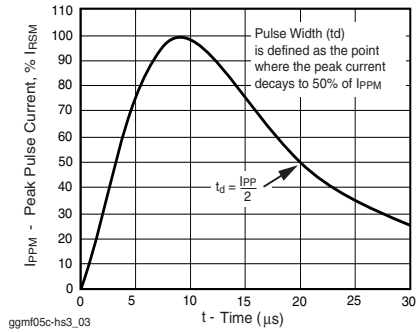

Figure 3. Pulse Waveform

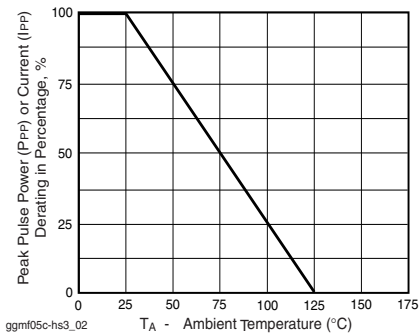

Figure 2. Pulse Derating Curve

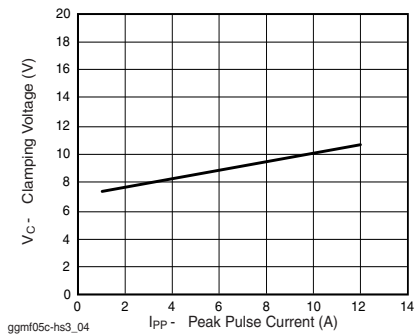

Figure 4. Clamping Voltage vs. Peak Pulse Current

**LLP75-6A Package Dimension  
see Package Section**

## ESD Protection Diode Array

### Features

- Transient protection for data lines as per  
**IEC 61000 - 4 - 2 (ESD) 15 kV (air), 8 kV (contact)**  
**IEC 61000 - 4 - 5 (Lightning) 5 A (tp = 8/20 μs)**
- Small package for use in portable electronics
- Bidirectional protection of 4 I/O lines
- Unidirectional protection of 5 I/O lines
- Low leakage current
- Ideal for cellular handsets, cordless phones, notebooks, handhelds and digital cameras

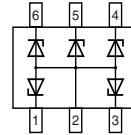
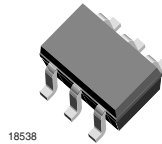

### Mechanical Data

**Case:** SOT-363 Plastic case

**Molding Compound Flammability Rating:**

UL 94 V-0

**Terminals:** High temperature soldering guaranteed:

260 °C/10 sec. at terminals

**Weight:** approx. 6.0 mg

### Parts Table

Part	Ordering code	Marking	Remarks
GMF05LC	GMF05LC-GS08	GM2	Tape and Reel

### Absolute Maximum Ratings

Ratings at 25 °C, ambient temperature unless otherwise specified

Parameter	Test condition	Symbol	Value	Unit
Peak pulse power	8/20 μs waveform	$P_{ppm}$	70	W
Peak pulse current	8/20 μs waveform	$I_{pp}$	5	A

### Thermal Characteristics

Ratings at 25 °C, ambient temperature unless otherwise specified

Parameter	Test condition	Symbol	Value	Unit
Operating temperature		$T_j$	- 55 to + 125	°C
Storage temperature		$T_{STG}$	- 55 to + 150	°C



### Electrical Characteristics

Ratings at 25 °C, ambient temperature unless otherwise specified

Parameter	Test condition	Symbol	Min	Typ.	Max	Unit
Reverse stand-off voltage		$V_{RWM}$			5	V
Reverse breakdown voltage	$I_t = 1 \text{ mA}$	$V_{BR}$	6			V
Reverse leakage current	$V_{RWM} = 5 \text{ V}$	$I_R$			0.1	$\mu\text{A}$
Clamping voltage	$I_{PP} = 1 \text{ A}$ , 8/20 $\mu\text{s}$ waveform	$V_C$			9.5	V
	$I_{PP} = 5 \text{ A}$ , 8/20 $\mu\text{s}$ waveform	$V_C$			12.5	V
Peak forward voltage	$I_F = 1 \text{ A}$ , 8/20 $\mu\text{s}$ waveform	$V_F$		1.5		V
Junction capacitance between I/O pins and Gnd	$V_R = 0 \text{ V}$ , $f = 1 \text{ MHz}$	$C_j$			50	pF

### Typical Characteristics ( $T_{amb} = 25 \text{ }^\circ\text{C}$ unless otherwise specified)

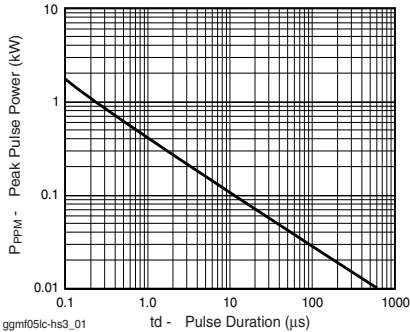

Figure 1. Non-Repetitive Peak Pulse Power vs. Pulse Time

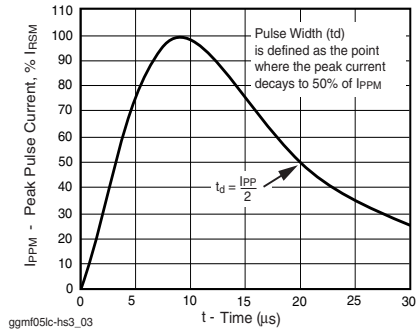

Figure 3. Pulse Waveform

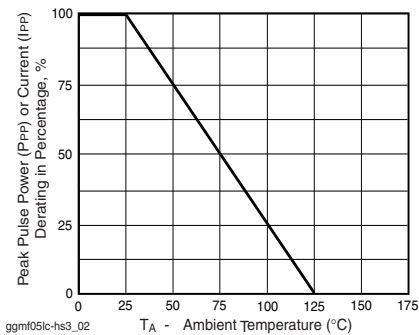

Figure 2. Pulse Derating Curve

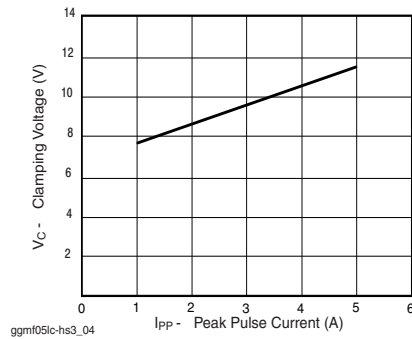

Figure 4. Clamping Voltage vs. Peak Pulse Current

**SOT-363 Package Dimension**  
see Package Section

## Low Capacitance ESD Protection Diode Array

### Features

- Transient protection for data lines as per  
**IEC 61000 - 4 - 2 (ESD) 15 kV (air), 8 kV (contact)**  
**IEC 61000 - 4 - 5 (Lightning) 5 A (tp = 8/20 μs)**
- Small package for use in portable electronics
- Bidirectional protection of 4 I/O lines
- Unidirectional protection of 5 I/O lines
- Low leakage current
- Ideal for cellular handsets, cordless phones, notebooks, handhelds and digital cameras
- Space saving LLP package

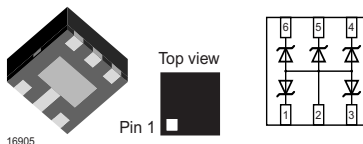

### Mechanical Data

**Case:** LLP75-6A Plastic case

**Molding Compound Flammability Rating:**

UL 94 V-0

**Terminals:** High temperature soldering guaranteed:  
 260 °C/10 sec. at terminals

**Weight:** approx. 5.2 mg

### Parts Table

Part	Ordering code	Marking	Remarks
GMF05LC-HS3	GMF05LC-HS3-GS08	F6	Tape and Reel

### Absolute Maximum Ratings

Ratings at 25 °C, ambient temperature unless otherwise specified

Parameter	Test condition	Symbol	Value	Unit
Peak pulse power	8/20 μs waveform	$P_{ppm}$	70	W
Peak pulse current	8/20 μs waveform	$I_{pp}$	5	A

### Thermal Characteristics

Ratings at 25 °C, ambient temperature unless otherwise specified

Parameter	Test condition	Symbol	Value	Unit
Operating temperature		$T_j$	- 55 to + 125	°C
Storage temperature		$T_{STG}$	- 55 to + 150	°C

### Electrical Characteristics

Ratings at 25 °C, ambient temperature unless otherwise specified

Parameter	Test condition	Symbol	Min	Typ.	Max	Unit
Reverse stand-off voltage		$V_{RWM}$			5	V
Reverse breakdown voltage	$I_t = 1 \text{ mA}$	$V_{BR}$	6			V
Reverse leakage current	$V_{RWM} = 5 \text{ V}$	$I_R$			0.1	$\mu\text{A}$
Clamping voltage	$I_{PP} = 1 \text{ A}$ , 8/20 $\mu\text{s}$ waveform	$V_C$			9.5	V
	$I_{PP} = 5 \text{ A}$ , 8/20 $\mu\text{s}$ waveform	$V_C$			12.5	V
Peak forward voltage	$I_F = 1 \text{ A}$ , 8/20 $\mu\text{s}$ waveform	$V_F$		1.5		V
Junction capacitance between I/O pins and Gnd	$V_R = 0 \text{ V}$ , $f = 1 \text{ MHz}$	$C_j$			50	pF

### Typical Characteristics ( $T_{amb} = 25 \text{ }^\circ\text{C}$ unless otherwise specified)

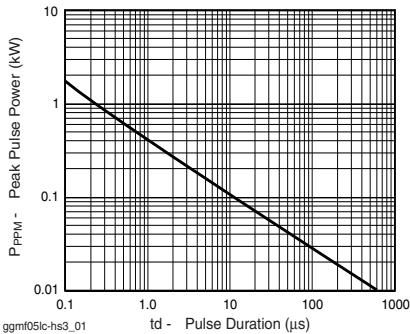

Figure 1. Non-Repetitive Peak Pulse Power vs. Pulse Time

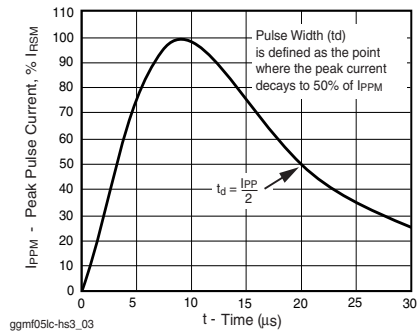

Figure 3. Pulse Waveform

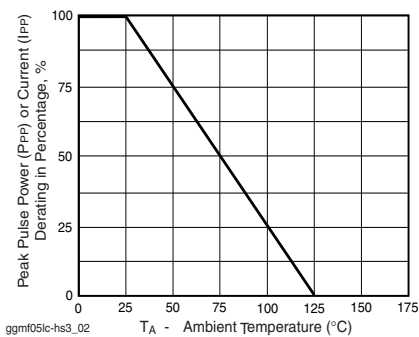

Figure 2. Pulse Derating Curve

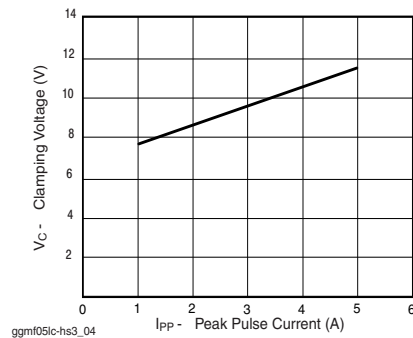

Figure 4. Clamping Voltage vs. Peak Pulse Current

**LLP75-6A Package Dimension  
see Package Section**

## Low Capacitance ESD Protection Diode Array

### Features

- Transient protection for data lines as per  
**IEC 61000 - 4 - 2 (ESD) 15 kV (air), 8 kV (contact)**  
**IEC 61000 - 4 - 5 (Lightning) 7 A (tp = 8/20 μs)**
- Small package for use in portable electronics
- Bidirectional protection of 4 I/O lines
- Unidirectional protection of 5 I/O lines
- Low leakage current
- Ideal for cellular handsets, cordless phones, notebooks, handhelds and digital cameras

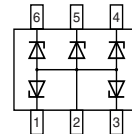
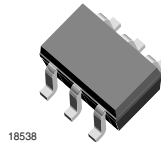

### Mechanical Data

**Case:** SOT-363 Plastic case

**Molding Compound Flammability Rating:**

UL 94 V-0

**Terminals:** High temperature soldering guaranteed:

260 °C/10 sec. at terminals

**Weight:** approx. 6.0 mg

### Parts Table

Part	Ordering code	Marking	Remarks
GMF05MC	GMF05MC-GS08	GM3	Tape and Reel

### Absolute Maximum Ratings

Ratings at 25 °C, ambient temperature unless otherwise specified

Parameter	Test condition	Symbol	Value	Unit
Peak pulse power	8/20 μs waveform	$P_{ppm}$	100	W
Peak pulse current	8/20 μs waveform	$I_{pp}$	7	A

### Thermal Characteristics

Ratings at 25 °C, ambient temperature unless otherwise specified

Parameter	Test condition	Symbol	Value	Unit
Operating temperature		$T_j$	- 55 to + 125	°C
Storage temperature		$T_{STG}$	- 55 to + 150	°C

### Electrical Characteristics

Ratings at 25 °C, ambient temperature unless otherwise specified

Parameter	Test condition	Symbol	Min	Typ.	Max	Unit
Reverse stand-off voltage		$V_{RWM}$			5	V
Reverse breakdown voltage	$I_t = 1 \text{ mA}$	$V_{BR}$	6			V
Reverse leakage current	$V_{RWM} = 5 \text{ V}$	$I_R$			0.2	$\mu\text{A}$
Clamping voltage	$I_{PP} = 1 \text{ A}$ , 8/20 $\mu\text{s}$ waveform	$V_C$			9	V
	$I_{PP} = 7 \text{ A}$ , 8/20 $\mu\text{s}$ waveform	$V_C$			12	V
Peak forward voltage	$I_F = 1 \text{ A}$ , 8/20 $\mu\text{s}$ waveform	$V_F$		1.5		V
Junction capacitance between I/O pins and Gnd	$V_R = 0 \text{ V}$ , $f = 1 \text{ MHz}$	$C_j$			75	pF

### Typical Characteristics ( $T_{amb} = 25 \text{ }^\circ\text{C}$ unless otherwise specified)

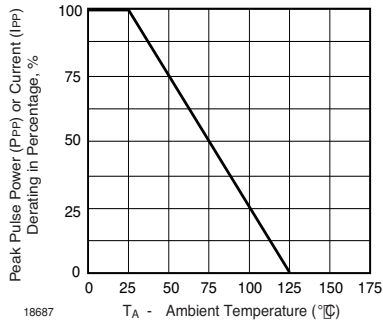

Figure 1. Pulse Derating Curve

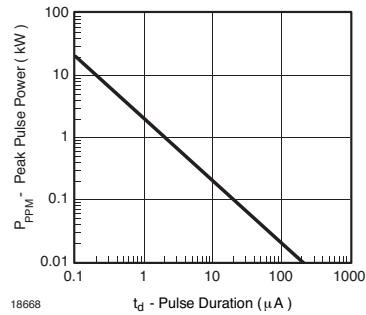

Figure 3. Non -Repetitive Peak Pulse Power vs. Pulse Time

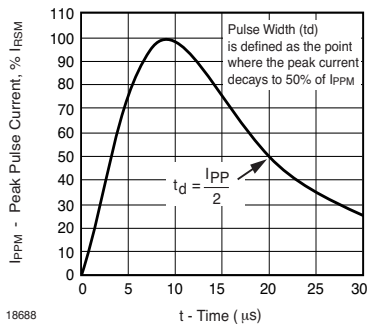

Figure 2. Pulse Waveform

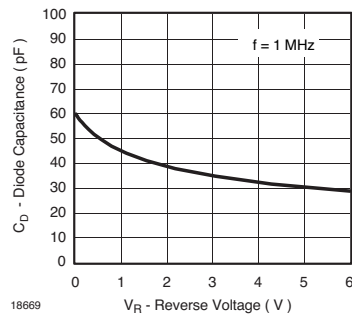

Figure 4. Typical Capacitance vs. Reverse Voltage

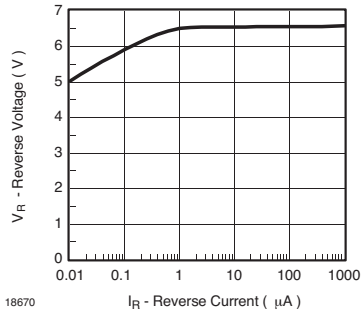

Figure 5. Typical Reverse Voltage vs. Reverse Current

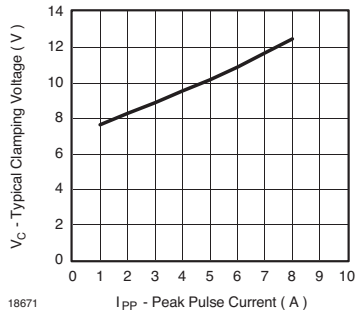

Figure 6. Typical Clamping Voltage vs. Peak Pulse Current

**SOT-363 Package Dimension**  
see Package Section



## Low Capacitance ESD Protection Diode Array

### Features

- Transient protection for data lines as per  
**IEC 61000 - 4 - 2 (ESD) 15 kV (air), 8 kV (contact)**  
**IEC 61000 - 4 - 5 (Lightning) 7 A (tp = 8/20 μs)**
- Small package for use in portable electronics
- Bidirectional protection of 4 I/O lines
- Unidirectional protection of 5 I/O lines
- Low leakage current
- Ideal for cellular handsets, cordless phones, notebooks, handhelds and digital cameras
- Space saving LLP package

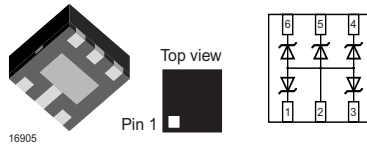

### Mechanical Data

**Case:** LLP75-6A Plastic case

**Molding Compound Flammability Rating:**

UL 94 V-0

**Terminals:** High temperature soldering guaranteed:

260 °C/10 sec. at terminals

**Weight:** approx. 5.2 mg

### Parts Table

Part	Ordering code	Marking	Remarks
GMF05MC-HS3	GMF05MC-HS3-GS08	F7	Tape and Reel

### Absolute Maximum Ratings

Ratings at 25 °C, ambient temperature unless otherwise specified

Parameter	Test condition	Symbol	Value	Unit
Peak pulse power	8/20 μs waveform	$P_{ppm}$	100	W
Peak pulse current	8/20 μs waveform	$I_{pp}$	7	A

### Thermal Characteristics

Ratings at 25 °C, ambient temperature unless otherwise specified

Parameter	Test condition	Symbol	Value	Unit
Operating temperature		$T_j$	- 55 to + 125	°C
Storage temperature		$T_{STG}$	- 55 to + 150	°C



### Electrical Characteristics

Ratings at 25 °C, ambient temperature unless otherwise specified

Parameter	Test condition	Symbol	Min	Typ.	Max	Unit
Reverse stand-off voltage		$V_{RWM}$			5	V
Reverse breakdown voltage	$I_t = 1 \text{ mA}$	$V_{BR}$	6			V
Reverse leakage current	$V_{RWM} = 5 \text{ V}$	$I_R$			0.2	$\mu\text{A}$
Clamping voltage	$I_{PP} = 1 \text{ A}$ , 8/20 $\mu\text{s}$ waveform	$V_C$			9	V
	$I_{PP} = 7 \text{ A}$ , 8/20 $\mu\text{s}$ waveform	$V_C$			12	V
Peak forward voltage	$I_F = 1 \text{ A}$ , 8/20 $\mu\text{s}$ waveform	$V_F$		1.5		V
Junction capacitance between I/O pins and Gnd	$V_R = 0 \text{ V}$ , $f = 1 \text{ MHz}$	$C_j$			75	pF

### Typical Characteristics ( $T_{amb} = 25 \text{ }^\circ\text{C}$ unless otherwise specified)

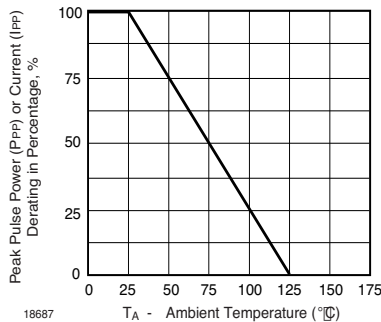

Figure 1. Pulse Derating Curve

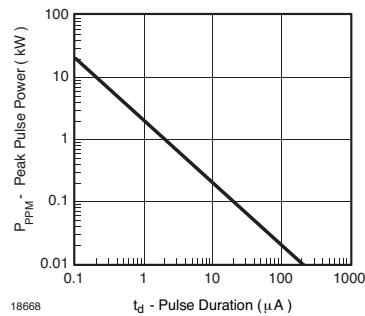

Figure 3. Non -Repetitive Peak Pulse Power vs. Pulse Time

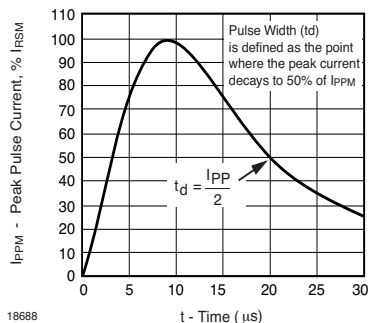

Figure 2. Pulse Waveform

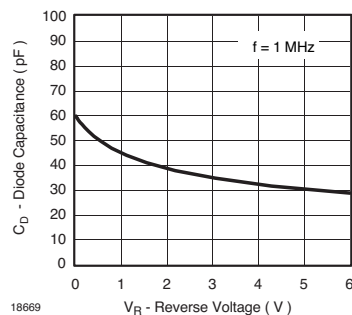

Figure 4. Typical Capacitance vs. Reverse Voltage

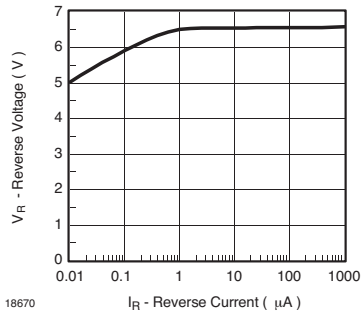

Figure 5. Typical Reverse Voltage vs. Reverse Current

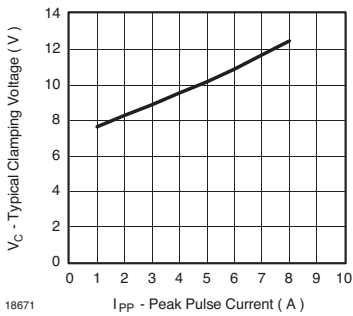

Figure 6. Typical Clamping Voltage vs. Peak Pulse Current

**LLP75-6A Package Dimension**  
**see Package Section**

# GMF05MC - HS3

Vishay Semiconductors

---



## ESD Protection Diode

### Features

- Transient protection for data lines as per IEC 61000-4-2 (ESD) 15 kV (air) 8 kV (contact) IEC 61000-4-5 (Lightning) see  $I_{PPM}$  below

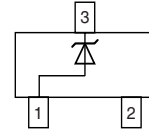
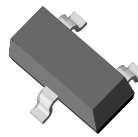

18078

### Mechanical Data

**Case:** SOT-23 Plastic case

**Molding Compound Flammability Rating:**

UL 94 V-0

**Terminals:** High temperature soldering guaranteed:

260 °C/10 sec. at terminals

**Weight:** approx. 8.8 mg

### Absolute Maximum Ratings

Ratings at 25 °C, ambient temperature unless otherwise specified

Parameter	Test condition	Symbol	Value	Unit
Peak power dissipation <sup>1)</sup>	8/20 μs pulse	$P_{PK}$	300	W
Forward surge current	8.3 ms single half sine-wave	$I_{FSM}$	7	A

<sup>1)</sup> Non-repetitive current pulse and derated above  $T_A = 25$  °C, for GSOT03, GSOT04, the peak power dissipation is 270 W

### Thermal Characteristics

Ratings at 25 °C, ambient temperature unless otherwise specified

Parameter	Test condition	Symbol	Value	Unit
Operation and storage temperature range		$T_{stg}, T_J$	- 55 to + 150	°C

### Electrical Characteristics

Partnumber	Device Marking Code	Rated Stand-off Voltage	Minimum Breakdown Voltage	Maximum Clamping Voltage		Maximum Pulse Peak Current	Maximum Leakage Current	Maximum Capacitance
				$V_C$	$V_C$			
		$V_{WM}$	$V_{BR}$	@ $I_p = 1$ A <sup>1)</sup>	@ $I_p = 5$ A <sup>1)</sup>	$I_{PPM}$	$I_D$	C
		V	V	V	V	A	μA	pF
GSOT03	03	3.3	4.0	6.5	7.5	18	125	800
GSOT04	04	4.0	5.0	8.5	10.5	17	125	800
GSOT05	05	5.0	6.0	9.8	12.5	17	100	550
GSOT08	08	8.0	8.5	13.4	15.0	15	10	400
GSOT12	12	12.0	13.3	19.0	28.0	12	2	185
GSOT15	15	15.0	16.7	24.0	35.0	10	1	140
GSOT24	24	24.0	26.7	43.0	60.0	5	1	83
GSOT36	36	36.0	40	60.0	75.0	2	1	80

<sup>1)</sup> 8/20 μs waveform used (see figure 2)

Typical Characteristics ( $T_{amb} = 25\text{ }^{\circ}\text{C}$  unless otherwise specified)

**SOT-23 Package Dimension  
see Package Section**

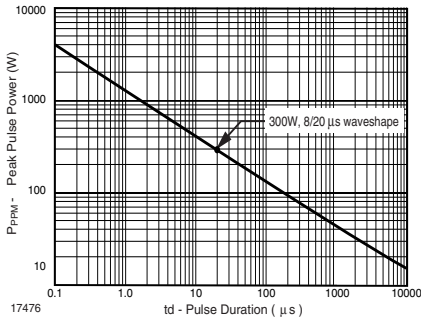

Figure 1. Non -Repetitive Peak Pulse Power vs. Pulse Time

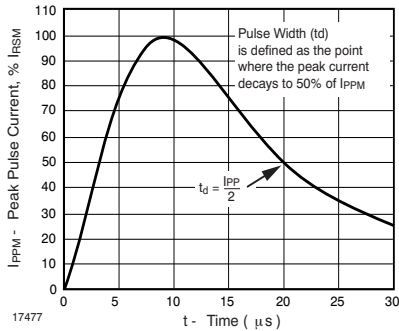

Figure 2. Pulse Waveform

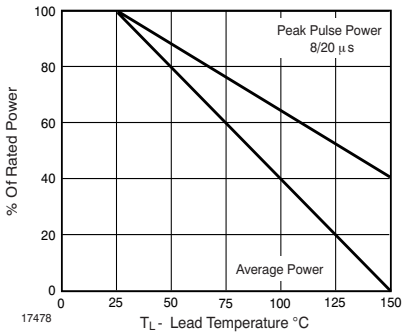
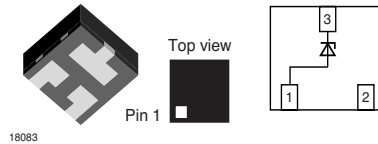

Figure 3. Power Derating

## ESD Protection Diode

### Features

- Transient protection for data lines as per IEC 61000-4-2 (ESD) 15 kV (air) 8 kV (contact) IEC 61000-4-5 (Lightning) see  $I_{PPM}$  below
- Space saving LLP package



### Mechanical Data

**Case:** LLP75-3B Plastic case

**Molding Compound Flammability Rating:**  
UL 94 V-0

**Terminals:** High temperature soldering guaranteed:  
260 °C/10 sec. at terminals

**Weight:** approx. 5.2 mg

### Parts Table

Part	Ordering code	Marking	Remarks
GSOT03-HT3	GSOT03-HT3-GS08	A3	Tape and Reel
GSOT04-HT3	GSOT04-HT3-GS08	A4	Tape and Reel
GSOT05-HT3	GSOT05-HT3-GS08	A5	Tape and Reel
GSOT08-HT3	GSOT08-HT3-GS08	A6	Tape and Reel
GSOT12-HT3	GSOT12-HT3-GS08	A7	Tape and Reel
GSOT15-HT3	GSOT15-HT3-GS08	A8	Tape and Reel
GSOT24-HT3	GSOT24-HT3-GS08	A9	Tape and Reel
GSOT36-HT3	GSOT36-HT3-GS08	AA	Tape and Reel

### Absolute Maximum Ratings

Ratings at 25 °C, ambient temperature unless otherwise specified

Parameter	Test condition	Symbol	Value	Unit
Peak power dissipation <sup>1)</sup>	8/20 $\mu$ s pulse	$P_{PK}$	300	W
Forward surge current	8.3 ms single half sine-wave	$I_{FSM}$	7	A

<sup>1)</sup> Non-repetitive current pulse and derated above  $T_A = 25$  °C

### Thermal Characteristics

Ratings at 25 °C, ambient temperature unless otherwise specified

Parameter	Test condition	Symbol	Value	Unit
Operation and storage temperature range		$T_{stg}, T_J$	- 55 to + 150	°C

# GSOT03-HT3 to GSOT36-HT3



Vishay Semiconductors

## Electrical Characteristics

Part Number	Device Marking Code	Rated Stand-off Voltage	Minimum Breakdown Voltage	Maximum Clamping Voltage		Maximum Pulse Peak Current	Maximum Leakage Current	Maximum Capacitance
				@ $I_{PP} = 1 \text{ A}$	@ $I_{PP} = 5 \text{ A}$			
		$V_{WM}$	$V_{BR}$	$V_C$		$I_{PPM}$	@ $V_{WM}$	@ 0 V, 1 MHz
		V	V	V		A	$\mu\text{A}$	pF
GSOT03-HT3	A3	3.3	4	6.5	7.5	18	125	800
GSOT04-HT3	A4	4	5	8.5	10.5	17	125	800
GSOT05-HT3	A5	5	6	9.8	12.5	17	100	550
GSOT08-HT3	A6	8	8.5	13.4	15	15	10	400
GSOT12-HT3	A7	12	13.3	19	28	12	2	185
GSOT15-HT3	A8	15	16.7	24	35	10	1	140
GSOT24-HT3	A9	24	26.7	43	60	5	1	83
GSOT36-HT3	AA	36	40	60	75	2	1	80

## Typical Characteristics ( $T_{amb} = 25^\circ\text{C}$ unless otherwise specified)

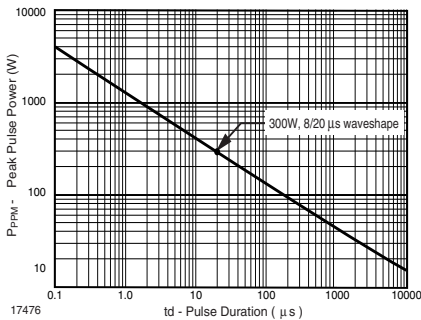

Figure 1. Non-Repulsive Peak Pulse Power vs. Pulse Time

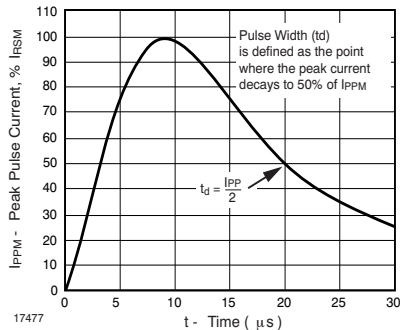

Figure 2. Pulse Waveform

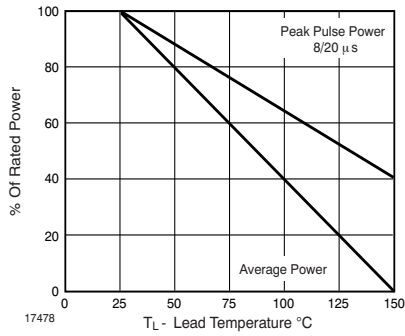

Figure 3. Power Derating

**LLP75-3B Package Dimension**  
see Package Section



# GSOT03-HT3 to GSOT36-HT3

Vishay Semiconductors

---



## 2-Line EMI-Filter with ESD -Protection

### Features

- Space saving LLP package
- EMI/RFI filtering with integrated ESD protection for two data lines
- ESD protection to **IEC 61000 - 4 - 2 Level 4**
- ESD protection to **IEC 61000 - 4 - 5 (4 A)**
- Low insertion loss up to 10 MHz
- Good attenuation of high frequency signals
- Low operating voltage (5 V)
- Low clamping voltage
- Low leakage current
- Thin film-on-silicon technology
- Ideal for cell phones, RF communication, and laptop computer applications

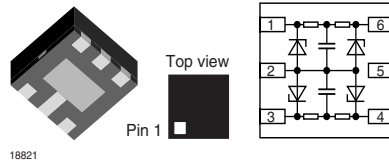

### Pinning:

- 1 = Input (Output) 1
- 2 = Ground
- 3 = Input (Output) 2
- 4 = Output (Input) 2
- 5 = not connect
- 6 = Output (input) 1

### Mechanical Data

**Case:** LLP75-6A Plastic case

**Molding Compound Flammability Rating:**

UL 94 V-0

**Terminals:** High temperature soldering guaranteed:  
260 °C/10 sec. at terminals

**Weight:** approx. 5.2 mg

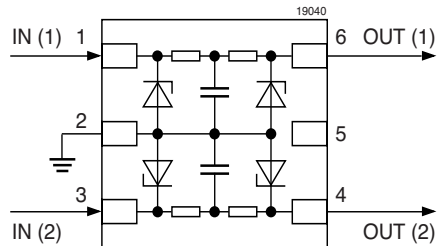

### Parts Table

Part	Ordering code	Marking	Remarks
GTF701-HS3	GTF701-HS3-GS08	T1	Tape and Reel

### Absolute Maximum Ratings

Ratings at 25 °C, ambient temperature unless otherwise specified

Parameter	Test condition	Symbol	Value	Unit
Steady -state power		P	100	mW
ESD Air discharge per IEC 61000-4-2		$V_{pp}$	15	kV
ESD Contact discharge per IEC 61000-4-2		$V_{pp}$	8	kV
Max. peak pulse current	8/20 $\mu$ s waveform	$I_{PPM}$	4	A

### Thermal Characteristics

Ratings at 25 °C, ambient temperature unless otherwise specified

Parameter	Test condition	Symbol	Value	Unit
Operating temperature		$T_j$	- 40 to + 125	°C
Storage temperature		$T_{STG}$	- 55 to + 150	°C

### Electrical Characteristics

Ratings at 25 °C, ambient temperature unless otherwise specified

Parameter	Test condition	Symbol	Min	Typ.	Max	Unit
Reverse stand-off voltage		$V_{RWM}$			5	V
Reverse breakdown voltage	$I_R = 1$ mA	$V_{BR}$	6			V
Reverse leakage current	$V_R = 5$ V	$I_R$			1	$\mu$ A
	$V_R = 3.3$ V	$I_R$			0.4	$\mu$ A
Total series resistance	$I_M = 1$ mA	R	45	50	55	$\Omega$
Total capacitance	$V_R = 0$ V, $f = 1$ MHz btw. I/O and GND	$C_{tot}$		120		pF
Clamping voltage	$I_{PP} = 4$ A, 8/20 $\mu$ s waveform	$V_C$			15	V

### Typical Characteristics ( $T_{amb} = 25$ °C unless otherwise specified)

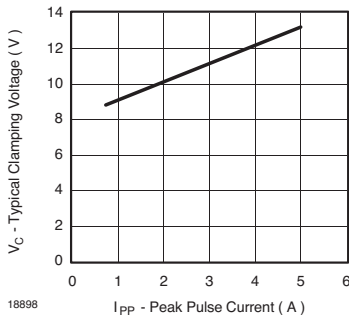

Figure 1. Typical Clamping Voltage vs. Peak Pulse Current

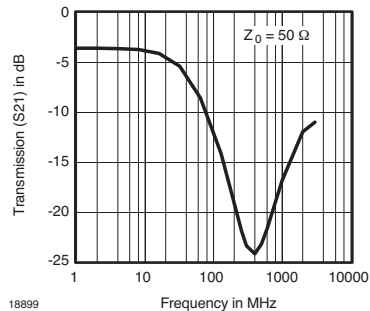

Figure 2. Typical Insertion Loss Characteristic

**LLP75-6A Package Dimension  
see Package Section**

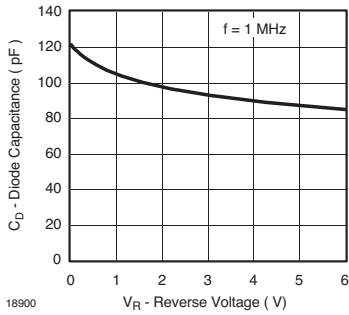

Figure 3. Typical Capacitance vs. Reverse Voltage

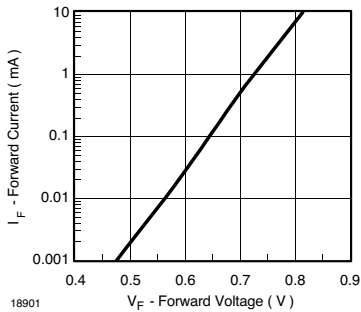

Figure 4. Forward Current vs. Forward Voltage

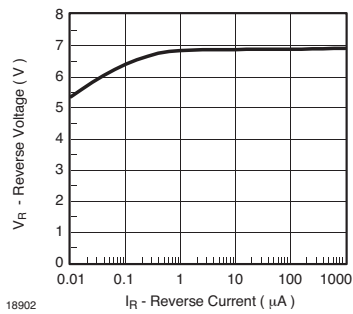

Figure 5. Typical Reverse Voltage vs. Reverse Current

# GTF701-HS3

Vishay Semiconductors

---



## Surface Mount ESD Protection Diodes

### Features

- For surface mounted applications
- Low-profile package
- Optimized for LAN protection applications
- Ideal for ESD protection of data lines in accordance with IEC 61000-4-2 (IEC801-2)
- Ideal for EFT protection of data lines in accordance with IEC 61000-4-4 (IEC801-4)
- IEC 61000-4-2 (ESD) 15 kV (air) 8 kV (contact)
- Low incremental surge resistance, excellent clamping capability
- 200 W peak pulse power capability with a 10/1000  $\mu$ s waveform, repetition rate (duty cycle): 0.01 %
- Very fast response time
- High temperature soldering guaranteed: 260 °C/ 10 seconds at terminals



17249

### Mechanical Data

**Case:** JEDEC DO-219AB (SMF<sup>®</sup>) Plastic case

**Terminals:** Solder plated, solderable per MIL-STD-750, Method 2026

**Polarity:** The band denotes the cathode, which is positive with respect to the anode under normal TVS operation

**Mounting Position:** Any

**Weight:** approx. 15 mg

**Packaging Codes/Options:**

GS18 / 10 k per 13 " reel (8 mm tape), 50 k/box

GS08 / 3 k per 7 " reel (8 mm tape), 30 k/box

### Absolute Maximum Ratings

Ratings at 25 °C, ambient temperature unless otherwise specified

Parameter	Test condition	Symbol	Value	Unit
Peak pulse power dissipation	10/1000 $\mu$ s waveform <sup>1)</sup>	P <sub>PPM</sub>	200	W
	8/20 $\mu$ s waveform <sup>1)</sup>	P <sub>PPM</sub>	1000	W
Peak pulse current	10/1000 $\mu$ s waveform <sup>1)</sup>	I <sub>PPM</sub>	next Table	A
Peak forward surge current	8.3 ms single half sine-wave	I <sub>FSM</sub>	20	A

<sup>1)</sup> Non-repetitive current pulse and derated above T<sub>A</sub> = 25 °C

### Thermal Characteristics

Ratings at 25 °C, ambient temperature unless otherwise specified

Parameter	Test condition	Symbol	Value	Unit
Thermal resistance <sup>2)</sup>		R <sub>thJA</sub>	180	K/W
Operation junction and storage temperature range		T <sub>stg</sub> , T <sub>J</sub>	- 55 to + 150	°C

# SMF5V0A to SMF51A



Vishay Semiconductors

## Electrical Characteristics

Ratings at 25 °C ambient temperature unless otherwise specified.  $V_F = 3.5$  V at  $I_F = 12$  A (uni-directional only)

Partnumber	Marking Code UNI	Breakdown Voltage <sup>1)</sup>	Test Current	Stand-off Voltage	Maximum Reverse Leakage	Maximum Peak Pulse Surge Current <sup>2,3)</sup>	Maximum Clamping Voltage	Junction Capacitance
		$V_{(BR)}$	@ $I_T$	$V_{WM}$	@ $V_{WM}$ $I_D$	$I_{PPM}$	@ $I_{PPM}$ $V_C$	$C_j$ @ $V_R = 0$ V, $f = 1$ MHz
		V	mA	V	$\mu$ A	A	V	pF
		min						typ
SMF5V0A	AE	6.40	10	5.0	400	21.7	9.2	1030
SMF6V0A	AG	6.67	10	6.0	400	19.4	10.3	1010
SMF6V5A	AK	7.22	10	6.5	250	17.9	11.2	850
SMF7V0A	AM	7.78	10	7.0	100	16.7	12.0	750
SMF7V5A	AP	8.33	1.0	7.5	50	15.5	12.9	730
SMF8V0A	AR	8.89	1.0	8.0	25	14.7	13.6	670
SMF8V5A	AT	9.44	1.0	8.5	10	13.9	14.4	660
SMF9V0A	AV	10.0	1.0	9.0	5.0	13.5	15.4	620
SMF10A	AX	11.1	1.0	10	2.5	11.8	17.0	570
SMF11A	AZ	12.2	1.0	11	2.5	11.0	18.2	460
SMF12A	BE	13.3	1.0	12	2.5	10.1	19.9	440
SMF13A	BG	14.4	1.0	13	1.0	9.3	21.5	420
SMF14A	BK	15.6	1.0	14	1.0	8.6	23.2	370
SMF15A	BM	16.7	1.0	15	1.0	8.2	24.4	350
SMF16A	BP	17.8	1.0	16	1.0	7.7	26.0	340
SMF17A	BR	18.9	1.0	17	1.0	7.2	27.6	310
SMF18A	BT	20.0	1.0	18	1.0	5.8	29.2	305
SMF20A	BV	22.2	1.0	20	1.0	6.2	32.4	207
SMF22A	BX	24.4	1.0	22	1.0	5.6	35.5	265
SMF24A	BZ	26.7	1.0	24	1.0	5.1	38.9	240
SMF26A	CE	28.9	1.0	26	1.0	4.8	42.1	225
SMF28A	CG	31.1	1.0	28	1.0	4.4	45.4	210
SMF30A	CK	33.3	1.0	30	1.0	4.1	48.4	205
SMF33A	CM	36.7	1.0	33	1.0	3.8	53.3	190
SMF36A	CP	40.0	1.0	36	1.0	3.4	58.1	180
SMF40A	CR	44.4	1.0	40	1.0	3.1	64.5	165
SMF43A	CT	47.8	1.0	43	1.0	2.9	69.4	160
SMF45A	CV	50.0	1.0	45	1.0	2.8	72.7	155
SMF48A	CX	53.3	1.0	48	1.0	2.6	77.4	150
SMF51A	CZ	56.7	1.0	51	1.0	2.4	82.4	145

<sup>1)</sup> Pulse test  $t_p \leq 5.0$  ms

<sup>2)</sup> Surge current waveform 10/1000  $\mu$ s

<sup>3)</sup> All terms and symbols are consistent with ANSI/IEEE C62.35

## Typical Characteristics ( $T_{amb} = 25\text{ }^{\circ}\text{C}$ unless otherwise specified)

**DO-219AB (SMF) Package Dimension see Package Section**

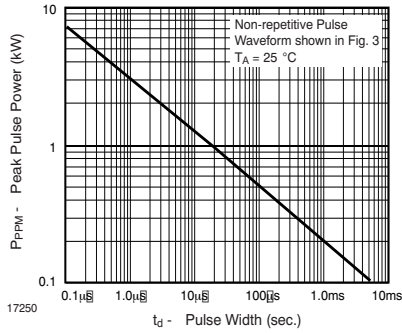

Figure 1. Peak Pulse Power Rating

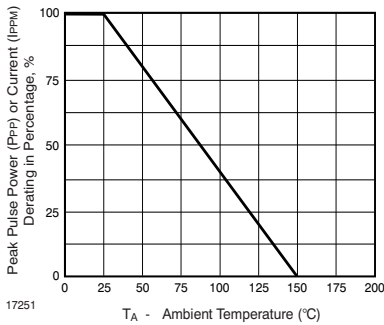

Figure 2. Pulse Derating Curve

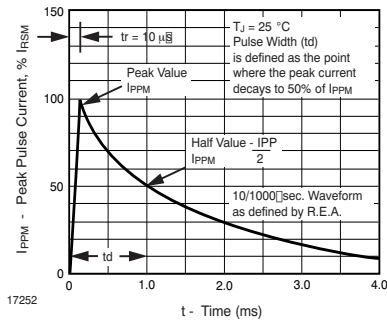

Figure 3. Pulse Waveform



# SMF5V0A to SMF51A

Vishay Semiconductors

---



## Flip Chip Protection Diode - Chip Size 0402

### Description

Flip Chip is a chip with all packaging and interconnections manufactured on the wafer prior to dicing. The interconnections are made of solder bumps on i/o pads. Our device utilizes a silicon P/N junction for excellent clamping (protection) performance with low leakage current characteristic.

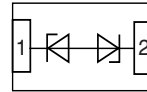
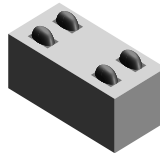

19120

### Features

- ESD protection to IEC 61000-4-2 30 kV (air)
- ESD protection to IEC 61000-4-2 8 kV (contact)
- ESD protection to IEC 61000-4-5 (lightning):  $8/20 \mu\text{s}$ ,  $I_{PPM} = 10 \text{ mA}$
- 120 W peak pulse power dissipation per line ( $8/20 \mu\text{s}$ )
- Suitable for high frequency applications (low capacitance, low parasitic inductance)
- Low clamping voltage
- Minimum PCB space needed ( $0.5 \text{ mm}^2$ ),  $< 0.55 \text{ mm}$  height, only  $0.47 \text{ mg/pcs}$
- No need for underfill material and/or additional solder
- Can be assembled using standard SMT pick & place equipment, reflow processes per J-STD-020 and assembly methods
- Green product

### Applications

Cellular phones  
 Personal digital assistants (PDA), notebook computers  
 MP3 players  
 GPS  
 Digital cameras  
 Bluetooth  
 Audio amplifiers  
 DVD  
 Power management systems  
 Read write heads for hard drives  
 Modules for watches  
 CPU  
 Digital TV's and satellites receivers  
 SMART cards

### Mechanical Data

**Case:** Flip Chip 1005  
 Standard EIA chip size: 0402  
 8 mm tape and reel per EIA-481-1-A/IEC60286  
 Top contacts: 4 solder bumps  $100 \mu\text{m}$  in height (nominal)  
 Bumps of SnAgCu (lead-free)<sup>1)</sup>  
<sup>1)</sup> also available with PbSn bumps

### Absolute Maximum Ratings

Ratings at 25 °C, ambient temperature unless otherwise specified

Parameter	Test condition	Symbol	Value	Unit
Peak pulse power dissipation <sup>1)</sup>	8/20 μs pulse	P <sub>PPM</sub>	120	W
Peak pulse current	8/20 μs pulse	I <sub>PPM</sub>	10	A
ESD Air discharge per IEC 61000-4-2		V <sub>ESD</sub>	>30	kV
ESD Contact discharge per IEC 61000-4-2		V <sub>ESD</sub>	>8	kV
Soldering temperature		T <sub>sd</sub>	260	°C
Soldering time		t	10	s

<sup>1)</sup> Non-repetitive current pulse

### Thermal Characteristics

Ratings at 25 °C, ambient temperature unless otherwise specified

Parameter	Test condition	Symbol	Value	Unit
Operating temperature		T <sub>J</sub>	- 55 to + 150	°C
Storage temperature		T <sub>STG</sub>	- 55 to + 150	°C

### Electrical Characteristics

Reverse Stand-off Voltage	Min. Breakdown Voltage	Max. Clamping Voltage		Max. Leakage Current	Capacitance
	V <sub>BR</sub>	@ I <sub>PPM</sub> = 1 A @ 8/20 μs	@ I <sub>PPM</sub> = 10 A @ 8/20 μs		@ V <sub>R</sub> = 0 V, f = 1 MHz
V <sub>RWM</sub>	@ 1 mA	V <sub>C</sub>		@ V <sub>RWM</sub>	C <sub>D</sub>
V	V	V	V	μA	pF
5	6	9	12	20	75

### Typical Characteristics (T<sub>amb</sub> = 25 °C unless otherwise specified)

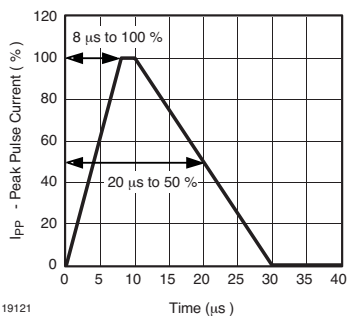

Figure 1. Pulse Waveform 8/20 μs acc. IEC 61000 - 4 - 5

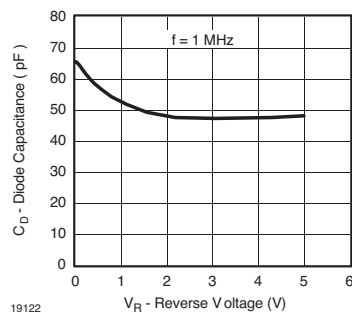

Figure 2. Typ. Diode Capacitance vs. Reverse Voltage

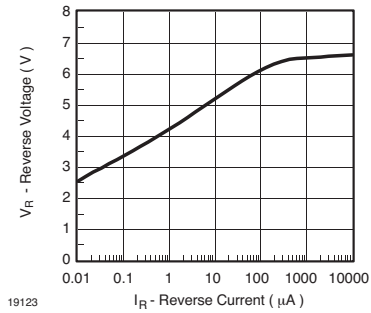

Figure 3. Reverse Voltage vs. Reverse Current

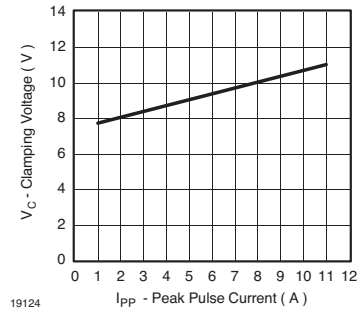

Figure 4. Clamping Voltage vs. Peak Pulse Current

**Flipchip 1005 Package Dimension  
see Package Section**

# VESD05C-FC1

Vishay Semiconductors



## Single ESD Protection Diode in SOD-523

### Features

- Small SOD-523 package
- Low leakage current
- ESD protection to IEC 61000-4-2 15 kV (air)
- ESD protection to IEC 61000-4-2 8 kV (contact)

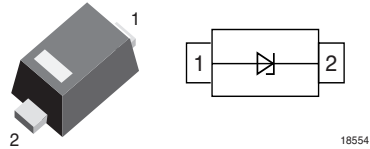

### Mechanical Data

**Case:** SOD-523 Plastic case

**Molding Compound Flammability Rating:**

UL 94 V-0

**Terminals:** High temperature soldering guaranteed:  
260 °C/10 sec. at terminals

**Weight:** approx. 1.6 mg

**Packaging Codes/Options:**

GS18 / 10 k per 13" reel (8 mm tape), 10 k/box

GS08 / 3 k per 7" reel (8 mm tape), 15 k/box

### Absolute Maximum Ratings

Ratings at 25 °C, ambient temperature unless otherwise specified

Parameter	Test condition	Symbol	Value	Unit
ESD Air discharge per IEC 61000-4-2		$V_{ESD}$	15	kV
ESD Contact discharge per IEC 61000-4-2		$V_{ESD}$	8	kV

### Thermal Characteristics

Ratings at 25 °C, ambient temperature unless otherwise specified

Parameter	Test condition	Symbol	Value	Unit
Operating temperature		$T_J$	- 40 to + 125	°C
Storage temperature		$T_{STG}$	- 55 to + 150	°C

## Electrical Characteristics

Partnumber	Marking Code	Reverse Stand-off Voltage	Max. Reverse Current	Max. Clamping Voltage	Max. Peak Pulse Current	Min. Reverse Breakdown Voltage	Capacitance
		@ $I_{Rmax}$	@ $V_{RWM}$	@ $I_{PPM}$ (see Fig. 1)	(see Fig. 1)	@ $I_R = 1 \text{ mA}$	@ $V_R = 0 \text{ V}$ , $f = 1 \text{ MHz}$
		$V_{RWM}$	$I_R$	$V_C$	$I_{PPM}$	$V_{BR}$	$C_D$
		V	$\mu\text{A}$	V	A	V	pF
VESD01-02V	A <sup>*)</sup>	1	100	9	7	1.5	180
VESD03-02V	B <sup>*)</sup>	3	20	12	9	4	110
VESD05-02V	C <sup>*)</sup>	5	0.1	20	6	6.5	55
VESD08-02V	D <sup>*)</sup>	8	0.1	30	4	9	35
VESD12-02V	E <sup>*)</sup>	12	0.1	25	2	14	30

<sup>\*)</sup> Number turned by 180°

## Typical Characteristics ( $T_{amb} = 25 \text{ }^\circ\text{C}$ unless otherwise specified)

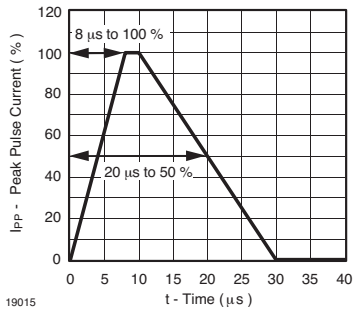

Figure 1. Pulse Waveform 8/20 μs acc. IEC 61000 - 4 - 5

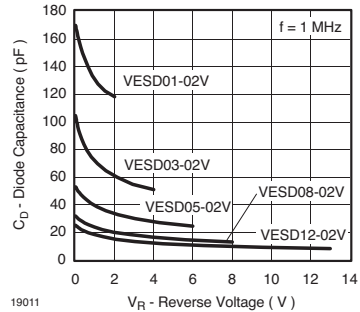

Figure 2. Typ. Diode Capacitance vs. Reverse Voltage

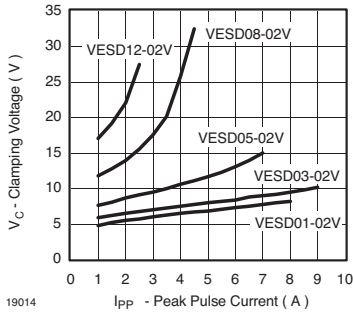

Figure 3. Clamping Voltage vs. Peak Pulse Current

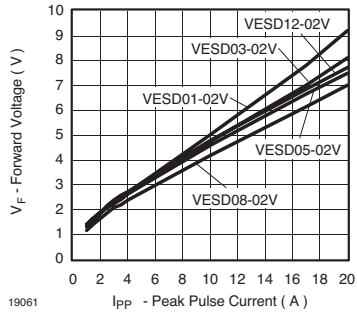

Figure 6. Typical Forward Voltage vs. Peak Pulse Current

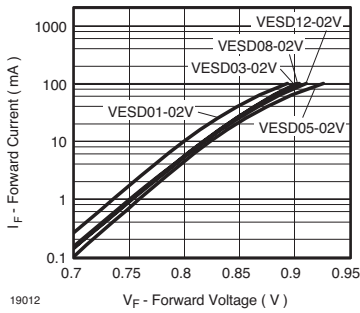

Figure 4. Forward Current vs. Forward Voltage

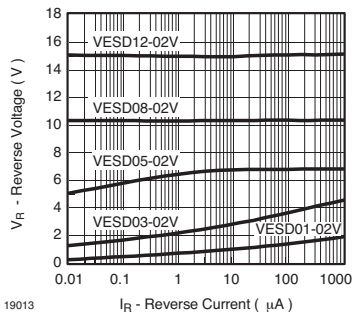

Figure 5. Reverse Voltage vs. Reverse Current

### SOD-523 Package Dimension see Package Section





Selector Guides



General Information



Zener Datasheets



ESD Datasheets



**Packages**

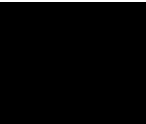

Application Notes



Glossary





## DO-214AC, Package Dimensions in mm (Inches)

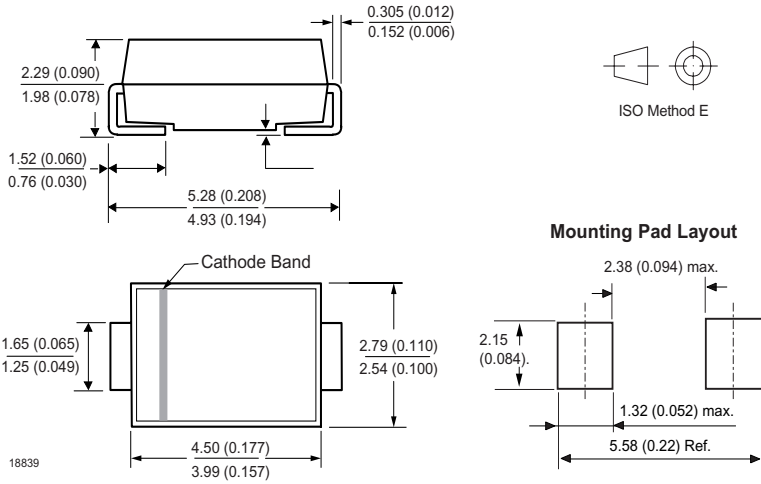

## DO-214AC(T), Package Dimensions in mm (Inches)

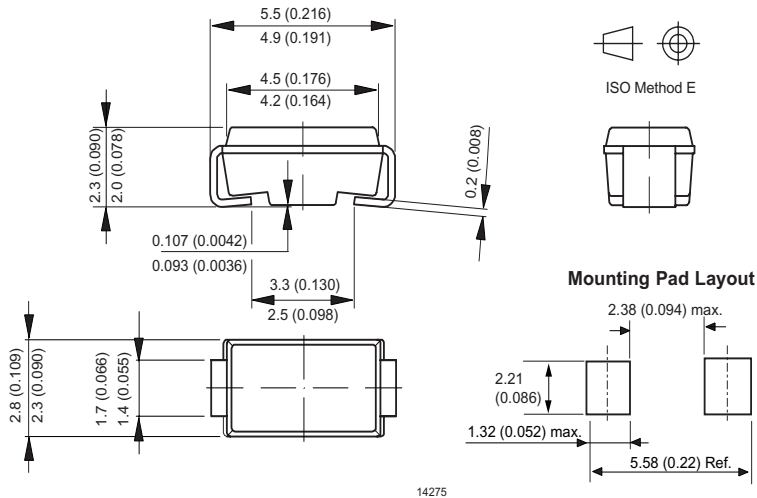

### DO-219AB (SMF), Package Dimensions in mm (Inches)

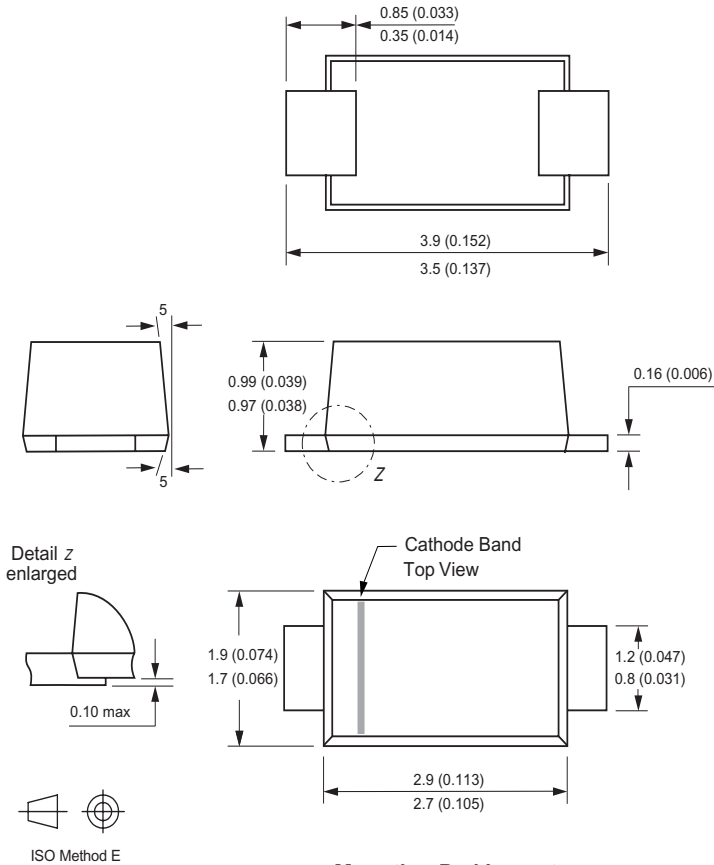

#### Mounting Pad Layout

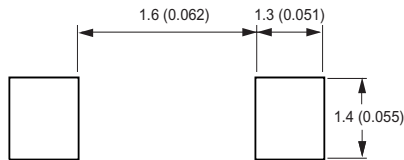

17247

## DO-35, Package Dimensions in mm (Inches)

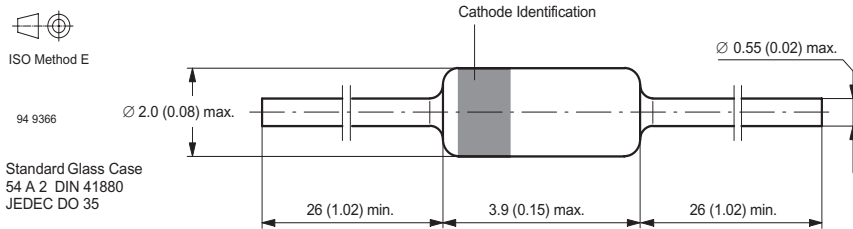

## DO-41 Glass, Package Dimensions in mm (Inches)

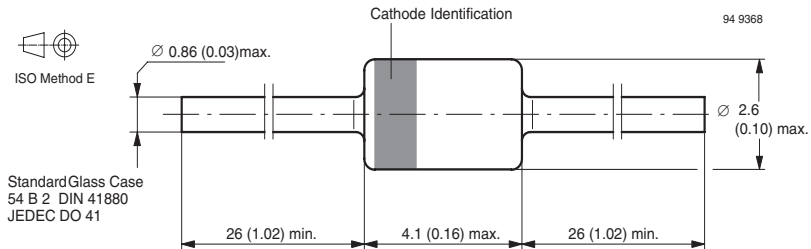

## Flipchip 1005, Package Dimensions in mm (Inches)

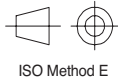
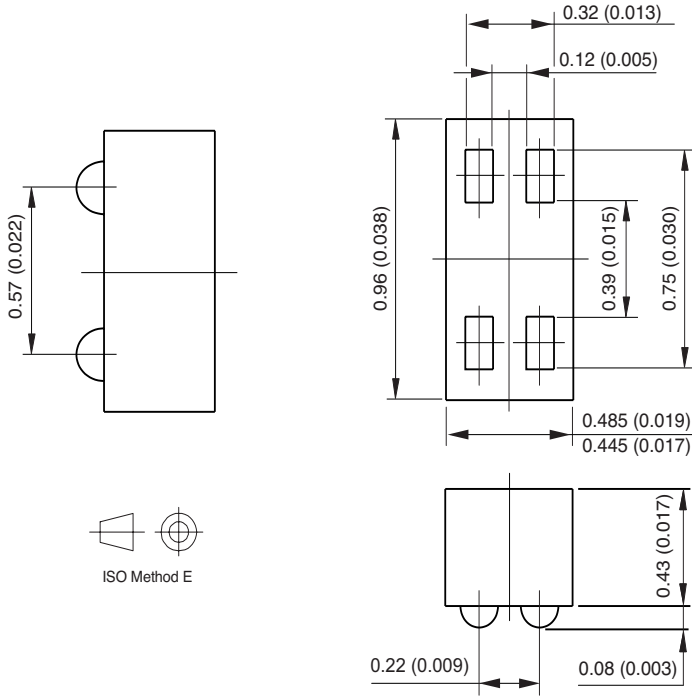

### Mounting Pad Layout

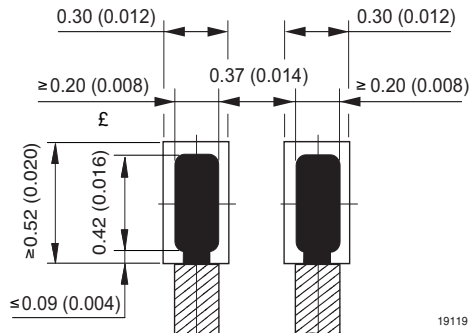

- Solder land
- Solder resist opening
- Copper area

19119

## LLP75-3B, Package Dimensions in mm (Inches)

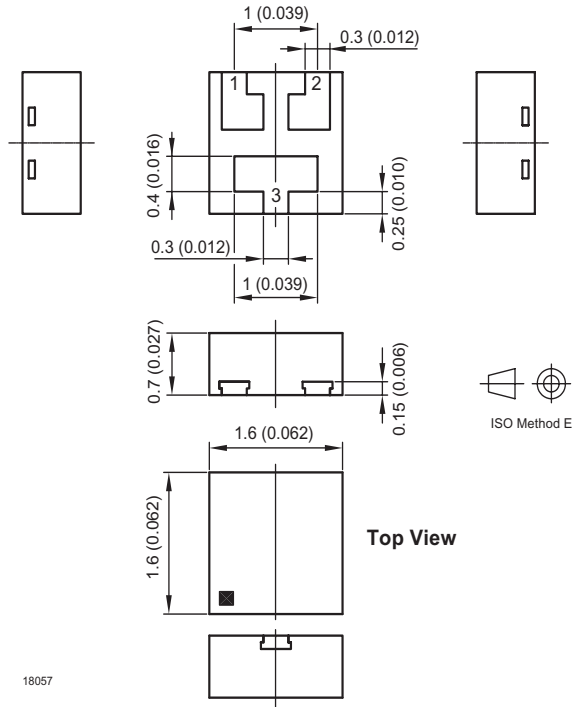

18057



# Packages

Vishay Semiconductors



## LLP75-6A, Package Dimensions in mm (Inches)

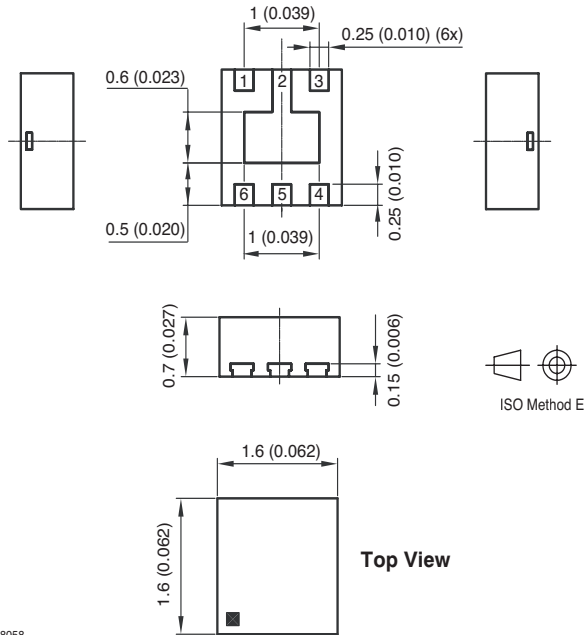

18058

## MELF Glass, Package Dimensions in mm (Inches)

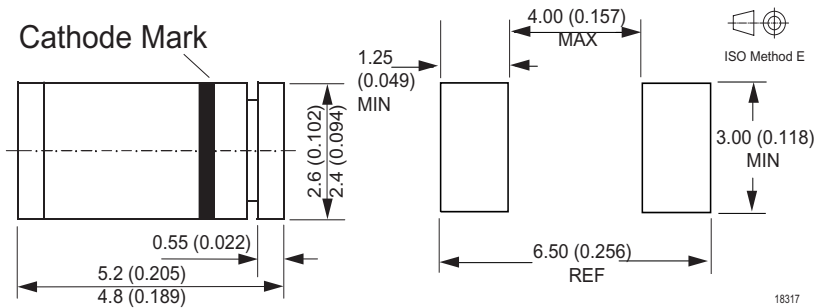

18317

## MicroMELF, Package Dimensions in mm (Inches)

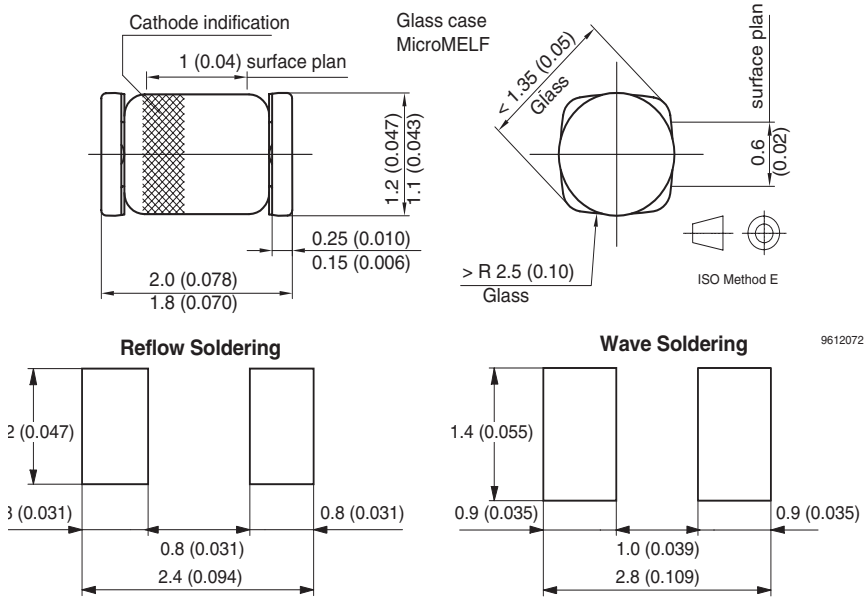

## MiniMELF SOD-80, Package Dimensions in mm (Inches)

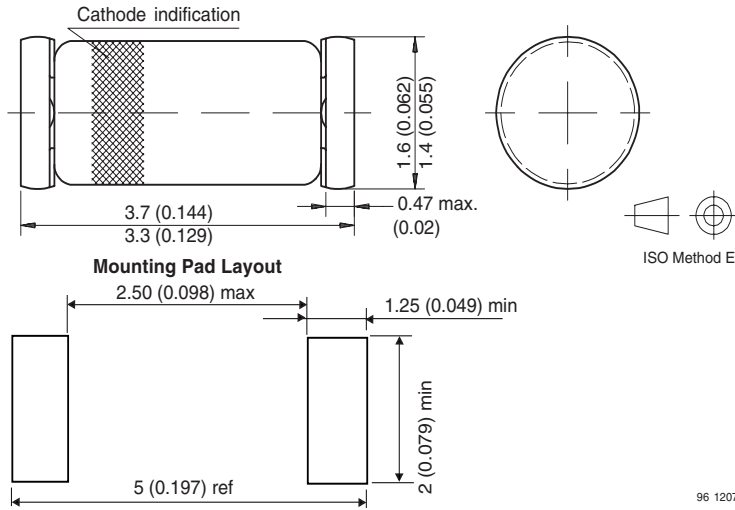

## QuadroMELF SOD-80, Package Dimensions in mm (Inches)

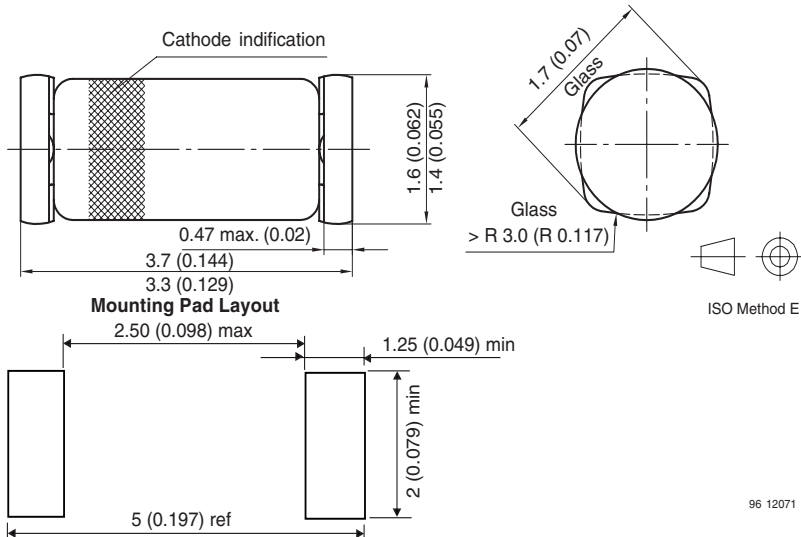

## SO-8, Package Dimensions in mm (Inches)

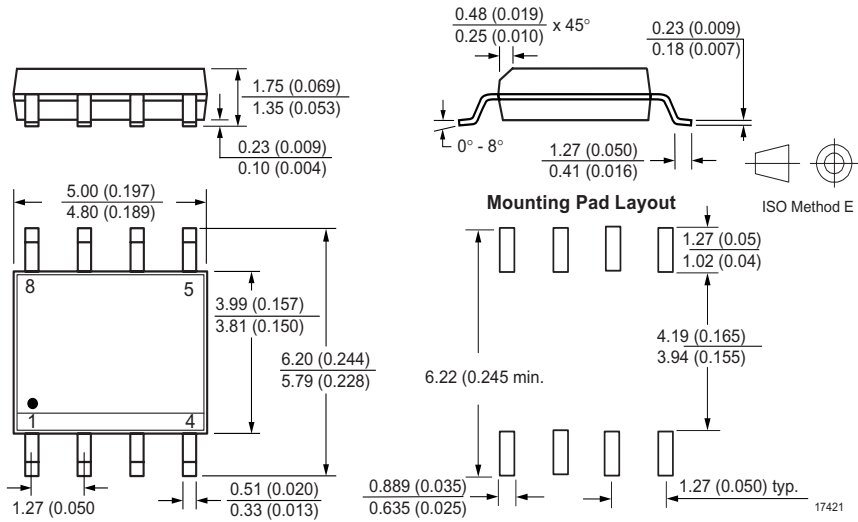

## SOD-123, Package Dimensions in mm (Inches)

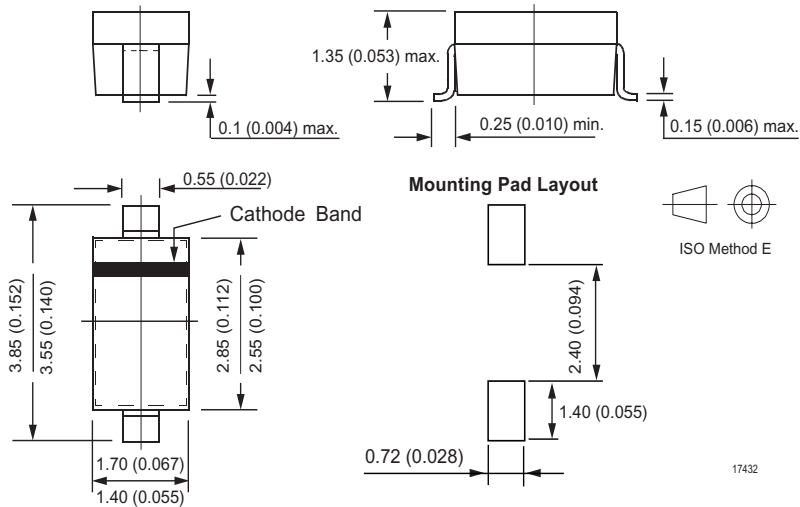

### SOD-323, Package Dimensions in mm (Inches)

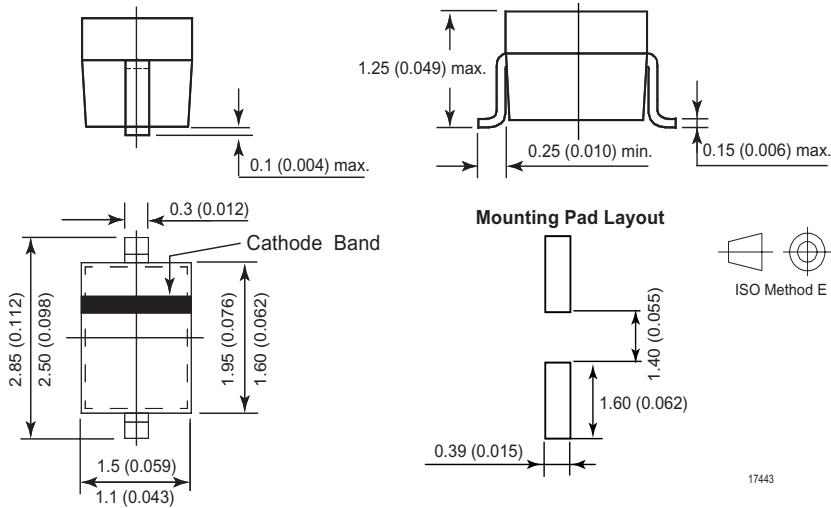

### SOD-523, Package Dimensions in mm (Inches)

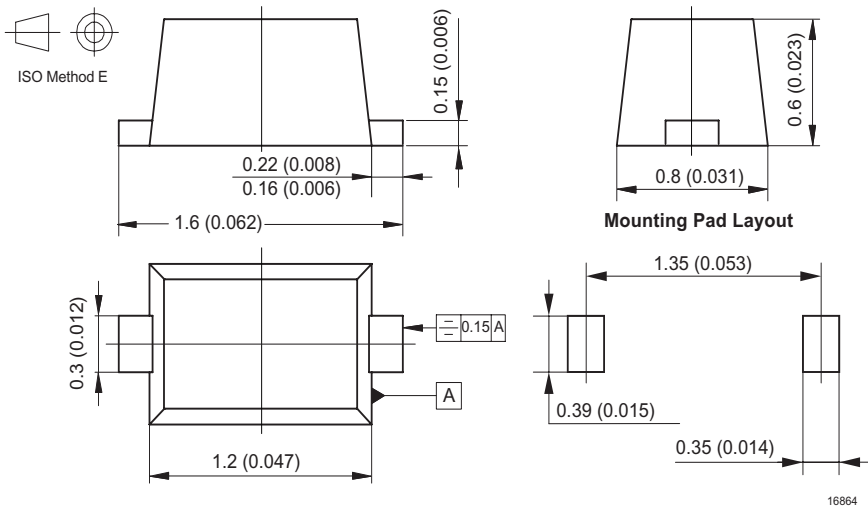

## SOD-57, Package Dimensions in mm (Inches)

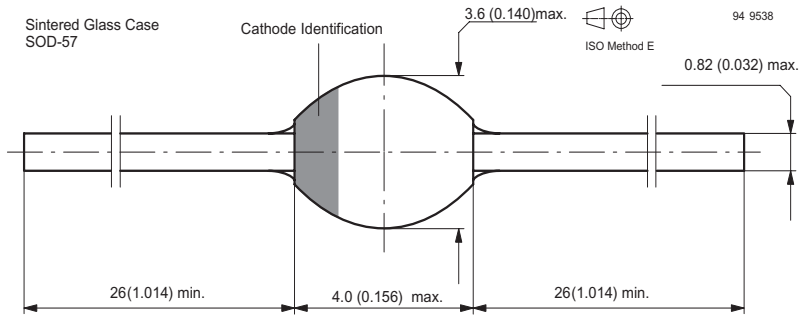

## SOD-64, Package Dimensions in mm (Inches)

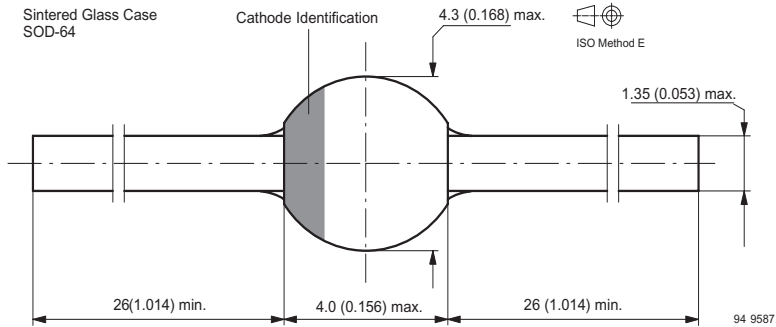

## SOT-143, Package Dimensions in mm

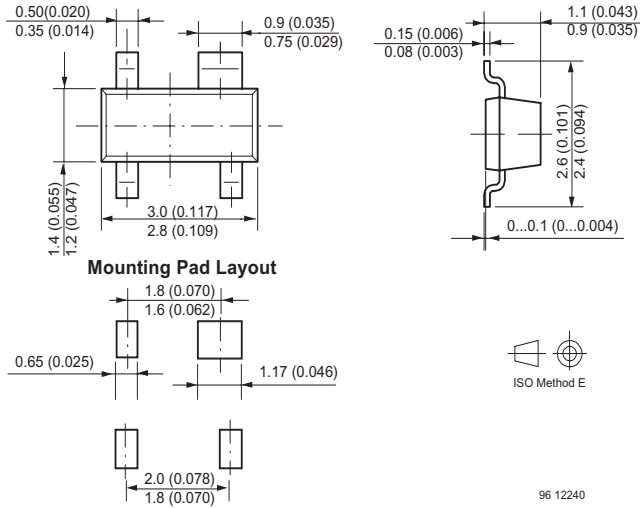

## SOT-23, Package Dimensions in mm (Inches)

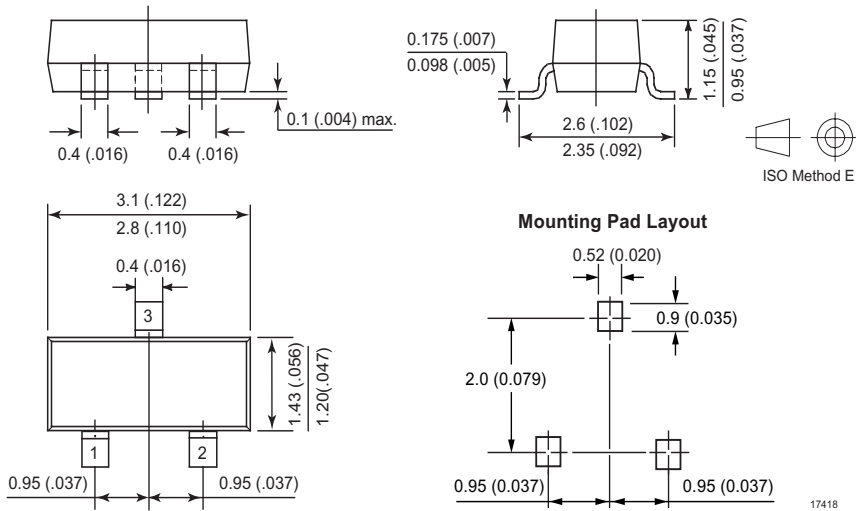

## SOT-363, Package Dimensions in mm (Inches)

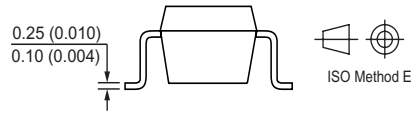
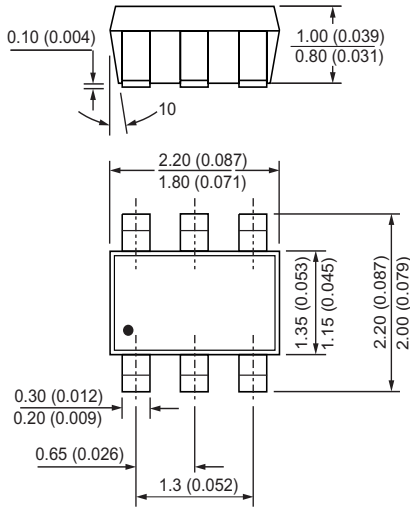

### Mounting Pad Layout

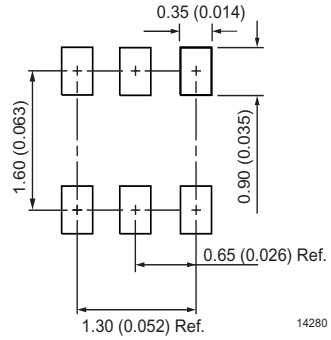

14280



# Packages

Vishay Semiconductors

---



Selector Guides



General Information



Zener Datasheets



ESD Datasheets



Packages



**Application Notes**

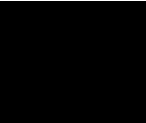

Glossary





# Silicon Zener Diodes

Zener diodes are special silicon diodes which have a relatively low, defined breakdown voltage, called the Zener voltage.

At low reverse voltages a Zener diode behaves in a similar manner to an ordinary silicon diode, that is, it passes only a very small leakage current. If, however, the reverse bias is increased until it reaches the breakdown region, then a small reverse voltage increase causes a considerable increase in leakage current; the reverse current is then called the Zener current. The characteristics of a Zener diode operating under reverse breakdown conditions are similar to those of a struck glow discharge tube. Because of this, Zener diodes can be used in a similar way, i. e. as stabilizers, limiters, ripple reduction elements, reference voltage sources, and also as DC coupling elements with a constant voltage drop.

A special kind of Zener diodes is the bi-directional Zener diode with breakdown characteristics in both directions.

The main features are:

- Energy absorption in both directions
- Very fast response
- Low Zener voltage variation from standby to peak pulse power load
- After power pulse load the bi-directional Zener diode automatically recovers to ready state

The bi-directional Zener diodes are designed to protect voltage sensitive components, integrated circuits, MOS devices, hybrids and complete electronic systems.

## Characteristics

The slope of the reverse breakdown characteristic defines the static differential resistance  $r_{zu} = dV_Z/dI_Z$ , which, in turn, comprises a dynamic (or inherent differential) resistance  $r_{zj}$  and a thermal differential resistance  $r_{zth}$ .

Use of the dynamic resistance alone for characterizing the performance of a Zener diode is only satisfactory if the ambient temperature can be assumed to be constant, and the Zener current variations are so rapid that the junction temperature is unable to follow them. A generalized design approach requires that the effect of slow Zener current variations is also taken into consideration, in which case the design must be based on the static differential resistance value  $r_{zu}$ , which is the sum of the dynamic and the thermal differential resistance:

$$r_{zu} = r_{zj} + r_{zth}$$

At  $T_{amb} = \text{const.}$ ,  
 $V_Z = f(I_Z, T)$   
 so that

$$\frac{dV_Z}{dI_Z} = \left(\frac{\delta V_Z}{\delta I_Z}\right)_T + \left(\frac{\delta V_Z}{\delta T}\right) I_Z \frac{dT}{dI_Z} \quad (1)$$

Setting

$$\frac{dV_Z}{V_Z \cdot dt} = \alpha_{vz} \quad (2) \text{ and } \frac{dT}{V_Z \cdot dI_Z} = R_{thA} \quad (3)$$

$$\text{yields } r_{zu} = r_{zj} + V_Z^2 \cdot \alpha_{vz} \cdot R_{thA} = r_{zj} + r_{zth} \quad (4)$$

where  $\alpha_{vz}$  is the Zener voltage temperature coefficient,  $T$  the junction temperature, and  $R_{thA}$  the thermal resistance between the junction and the ambient air.

The dynamic resistance is largely dependent on current, and decreases as the Zener current increases. The temperature coefficient  $\alpha_{vz}$  is dependent on temperature, but only at Zener voltages below 7 V.

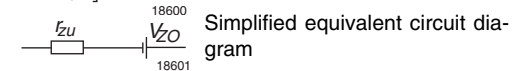
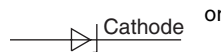
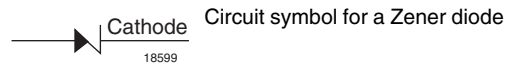

$V_{Z0}$  is the breakdown voltage, extrapolated for  $I_Z = 0$ .

## Design of Stabilizer Circuits

To simplify the design procedure, a constant differential resistance  $r_z$  is assumed in the following expressions. Since this does not strictly apply (as has been pointed out previously), an  $r_z$  value which lies in the middle of the stabilization range should be used. It is also assumed that  $T_{amb}$  is constant.

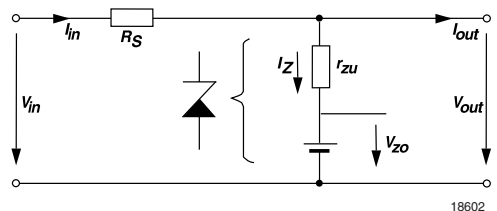

## Vishay Semiconductors

In the above circuit, the Zener diode is replaced by an equivalent circuit comprising a constant voltage generator giving a DC voltage of  $V_{Z0}$  in series with a differential resistance  $r_{ZU}$ . Other parameters in this circuit diagram are:  $V_{out}$  = output voltage,  $I_{out}$  = output current,  $V_{in}$  = input voltage,  $I_{in}$  = input current,  $I_Z$  = Zener current, and  $R_S$  = series resistance.

The following equations apply

$$V_{in} - V_{out} = (I_{out} + I_Z) \cdot R_S \quad (5)$$

$$V_{out} - V_{Z0} = I_Z \cdot r_{ZU} \quad (6)$$

If equation (6) is combined with equation (5) one obtains

$$V_{in} = V_{out} + I_{out} \cdot R_S + (V_{out} - V_{Z0}) \cdot \frac{R_S}{r_{ZU}} \quad (7)$$

Differentiation yields the smoothing factor

$$G = \frac{dV_{in}}{dV_{out}} = 1 + \frac{R_S}{r_{ZU}} \quad (8)$$

where  $I_{out}$  is assumed to be constant.

Because  $R_S$  is, as a rule, very much larger than  $r_{ZU}$ , the smoothing factor  $G$  can be taken as being approximately equal to the ratio  $R_S/r_{ZU}$ . As can be deduced from equation (8),  $G$  increases linearly with  $R_S$  (provided that  $V_{in}$  is also increased), and, if  $V_{in}$  and  $R_S$  approach infinity, the  $G$  will also approach infinity.

More important than the smoothing factor is the stabilization factor  $S$ , i. e. the ratio of a relative input voltage change to a relative output voltage change:

$$S = \frac{\frac{dV_{in}}{V_{in}}}{\frac{dV_{out}}{V_{out}}} = \left(1 + \frac{R_S}{r_{ZU}}\right) \cdot \frac{V_{out}}{V_{in}} \quad (9)$$

The stabilization factor, unlike the smoothing factor, does not increase linearly with  $V_{in}$  and  $R_S$ , but approaches a finite limit value when  $V_{in}$  and  $R_S \rightarrow \infty$ . In order to determine this limit value,  $R_S$  is eliminated from equation (9) by the use of equation (5):

$$R_S = \frac{V_{in} - V_{out}}{I_{in} + I_{out}} = \frac{V_{in} - V_{out}}{I_{in}}$$

with the result that

$$S = \frac{V_{out}}{V_{in}} + \frac{V_{out}}{I_{in} \cdot r_{ZU}} \cdot \left(1 + \frac{V_{out}}{V_{in}}\right) \quad (10)$$

If  $V_{in} \rightarrow \infty$ , then this reduces to

$$S_{max} = \frac{V_{out}}{I_{in} \cdot r_{ZU}} \quad (11)$$

It can be seen that for a given Zener diode and a given load, the stabilization improves as the input voltage is increased; it should be noted, however, that the power dissipated in the diode series resistor rises at a higher rate than that at which the stabilization factor is increased. As a sensible compromise between the requirements of good stabilization and acceptable power dissipation, it is suggested that the input voltage be made about 2 to 4 times the value of the output voltage.

The output resistance presented by the stabilizer is equal to the diode series resistance  $R_S$  in parallel with the differential resistance  $r_{ZU}$  of the diode. Since  $R_S$  is usually very much larger than  $r_{ZU}$ , the stabilizer output resistance is virtually equal to  $r_{ZU}$ . It should be noted that in this calculation  $R_S$  includes the source resistance of the input supply so that  $V_{in}$  is the source EMF.

Other important factors which must be taken into consideration in the design of a shunt stabilizer are, apart from the stabilization factor and the output resistance, the maximum admissible power dissipation and the maximum admissible Zener current. These must not be exceeded under maximum input voltage and minimum load current conditions. The following conditions must be fulfilled:

$$V_{out} \cdot \left(\frac{V_{in,max} - V_{out}}{R_S} - I_{out,min}\right) < P_{tot} \quad (12)$$

$$R_S > \frac{V_{in,max} - V_{out}}{I_{Z,max} + I_{out,min}} \quad (13)$$

Finally, steps must be taken to ensure that the output current  $I_{out}$  does not become excessive. If the input voltage is constant, then the Zener current decreases in the same proportion as the output current increases. However, at very small Zener currents the dynamic resistance of the Zener diode rises sharply and the stabilization performance is correspondingly degraded.

Therefore, the following conditions must be fulfilled:

$$\left(\frac{V_{in,min} - V_{out}}{R_S} - I_{out,max}\right) > I_{Z,min} \quad (14)$$

$$R_S < \frac{V_{in,min} - V_{out}}{I_{Z,min} + I_{out,max}} \quad (15)$$

$I_{Z,min}$  should be 5 to 10 % of  $I_{Z,max}$ .

## **Breakdown Voltage (Zener Voltage) Measurements on Zener Diodes**

If a Zener diode is connected to a constant current source, then at constant ambient temperature, the Zener voltage changes and approaches asymptotically a final value. This voltage change is due to the power dissipated in the junction which in turn causes a rise in junction temperature. Zener diodes with a negative temperature coefficient exhibit a Zener voltage reduction, whereas those with a positive temperature coefficient show a Zener voltage increase on application of current. The magnitude of this voltage change due to intrinsic heat generation can be derived from the relevant curves.

Because it is not practical to wait during tests until each device has reached its thermal equilibrium, it is common practice to measure the breakdown voltage of Zener diodes by application of a pulsating current of less than 1 sec duration. Under these conditions the junction temperature is the same as the ambient temperature. The magnitude of the test current used varies from type to type and is quoted in the relevant data sheets.

Therefore, designers, but especially customers carrying out acceptance tests, should allow for the fact that the Zener voltage of a device which is at thermal equilibrium will differ from that quoted in the data sheet. To arrive at an estimate of the equilibrium Zener voltage, a voltage equal to the product of Zener current and thermal differential resistance should be added to the voltage associated with the chosen current as derived from the published dynamically measured breakdown curves.



# Test and Measurement Methods on Zener Diodes

## Introduction

The main feature of a Zener Diode is to give a threshold voltage, clamped to a fixed voltage. The bias current necessary for the function of the component will conduct to dissipate power. By dissipating this power, the junction will increase the junction temperature. Then some care must be paid before using such kind of devices by taking in account their thermal coefficient and thermal resistance which will have influence on the electrical function itself and the life duration of the diode. See also the application note "Breakdown voltage (Zener Voltage) Measurements on Zener Diodes".

Three common methods are briefly described below:

**A)** When using a Zener Diode inside an application, most of the time this component is used as a voltage stabilizer meaning that the device is biased with a DC current. Measuring the Zener Breakdown voltage is simply operated with a current source and a Voltmeter as follow on figure1.

It is recommended to use calibrated equipment to avoid any risk of mistake. The setting of the current source will be equal to the value  $I_z$  or  $I_{zt}$  given by the data book of the concerned device. The measurement must be done after the complete stabilizing of the device, in normal case 90 s after the start of the power on. This time can be reduced to 30 s for the lower Zener values from 1 to 10 V. Note that the temperature of the ambient\* has also an important influence of the reading, according to its thermal coefficient of Zener voltage. In GS product portfolio, several types of components are specified for a DC current condition, named 'THERMAL EQUILIBRIUM' as for example: 1N5225...1N5267 - MMBZ5225...MMBZ5267 - MMSZ5225...MMSZ5267 - 1N4728...1N4764 - ZM4728...ZM4764 - ZMM5225...ZMM5267

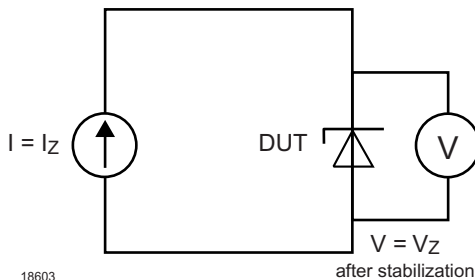

Figure 1.

**B)** Due to the large volume of components produced per day in General Semiconductor plants, it is commonly used a test pulse from 0,3 ms to 20 ms or more, depending of the type of the device and the parameter to read. The measurement is done by Automatic Test Equipment fitted for such purpose. In this case the ambient\* temperature condition is also important because of the thermal coefficient of Zener voltage. In laboratory, this test can simulated by a HF& pulse generator as the source and an oscilloscope for reading the value.

Then the reading of the value will be done only during a short time, smaller than the pulse duration, to avoid any disturbance caused by the rise or the fall ramp. See the figure 2 as principle of the measure. The Zener Diodes are mainly defined by the values tested with a test pulse, specified in the bottom of the table of the data sheets. Because of this short pulse test method, no self-heating of the component is provoked. Thus the final value must be evaluated based on the application conditions.

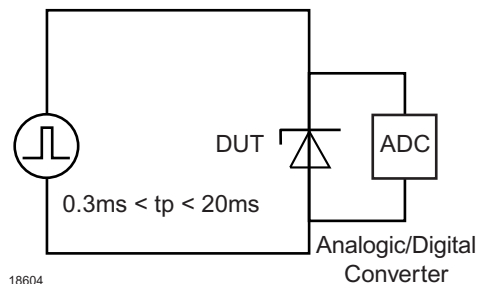

Figure 2.



## Vishay Semiconductors

C) Measure on curve tracer is also commonly used to characterize Zener voltage. The main feature of such equipment is to trace a curve  $V_Z$  versus  $I_Z$  from the specified values choose on the equipment. A particular care must be done about the lecture of the reading, due to the sinus waveform current used to trace the dvz characteristic depending on the  $d_{I_Z}$ , varying from a low to a bigger value. Measurement of the leakage current in DC condition offers the closer conditions to read a Zener value at thermal equilibrium, however often in a lower range of current than usually given for  $I_Z$  in the data sheets. These three test methods give important information about the global behavior of a Zener component, however they are not always compatible. Even of the use of DC condition on the curve tracer, a slight drift is still observed compared to the method of thermal equilibrium. The chart below is given as an example concerning one lot for one type.

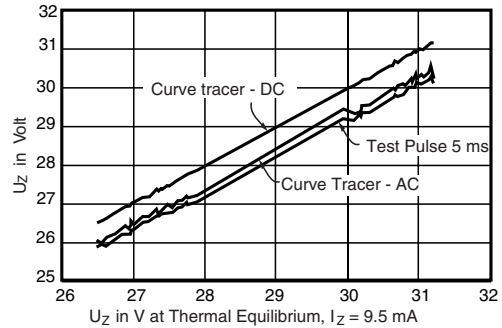

Figure 3. 1N4750 Different Test Methods Compared to Thermal Equilibrium

\* All methods must be done at a recommended ambient temperature  $25\text{ }^{\circ}\text{C} \pm 1$ . See also "Breakdown voltage (Zener Voltage) Measurements on Zener Diodes" and "Temperature - Compensated Stabilizing Circuits."



# Temperature-Compensated Stabilizing Circuits

Two Zener diode parameters in particular affect the stabilizer performance – the voltage temperature coefficient  $\alpha_{vz}$  and the differential resistance  $r_{zj}$ . These parameters are determined by the physical properties of the conventional Zener diodes and their effect on stabilization performance will be better appreciated if the simple stabilizer circuit shown in the figure below, consisting of a resistor in series with a Zener diode, is considered.

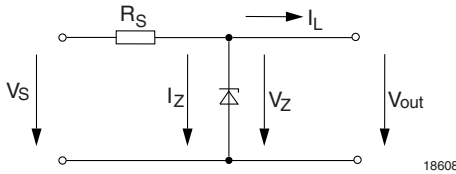

In this circuit the output voltage  $V_{out}$  (which in this case is the same as the Zener voltage  $V_Z$ ) is related to the supply voltage  $V_S$ , the load current  $I_L$  and the ambient temperature  $T_{amb}$  by the expression

$$\Delta V_{out} = \frac{r_z}{R_S} \cdot \Delta V_S + r_z \cdot \Delta I_L + \alpha_{vz} \cdot V_Z \cdot \Delta T_{amb} \quad (1)$$

As far as the differential resistance  $r_z$  is concerned a distinction should be made between the inherent differential resistance  $r_{zj}$  and the static differential resistance  $r_{zu}$ . The following equation applies:

$$r_{zu} = r_{zj} + \alpha_{vz} \cdot V_Z^2 \cdot R_{th} = r_{zj} + r_{zth} \quad (2)$$

where  $R_{th}$  is the thermal resistance and  $r_{zth}$  the thermal differential resistance of the diode.

The second term in this expression takes into account the change in dissipation  $V_Z \cdot \Delta I_L$  due to the current variation  $\Delta I_L$ , which, for a thermal resistance  $R_{th}$ , produces a crystal temperature change of

$$\Delta T_j = V_Z \cdot R_{th} \cdot \Delta I_L \quad (3)$$

and consequently an output change of

$$\Delta V_Z = \alpha_{vz} \cdot V_Z \cdot \Delta T_j = \alpha_{vz} \cdot V_Z^2 \cdot R_{th} \cdot \Delta I_L \quad (4)$$

Let us, by way of an example, calculate the performance of a stabilizer circuit which incorporates a Zener diode type ZPD22 from Vishay General Semiconductor and operates from a high supply voltage

and with low load current. For this type the following data are published for  $I_Z = 5 \text{ mA}$ :

$$V_Z = 22 \text{ V}$$

$$r_{zu} = r_{zj} + r_{zth} = 25 \Omega + 100 \Omega = 125 \Omega$$

$$\alpha_{vz} = 9 \cdot 10^{-4} / \text{K}$$

For a supply voltage of  $V_S = 220 \text{ V}$ , a load current of  $I_L = 5 \text{ mA}$  and a diode Zener current of  $I_Z = 5 \text{ mA}$  the value of the series resistor works out to

$$R_S = \frac{220 \text{ V} - 22 \text{ V}}{5 \text{ mA} + 5 \text{ mA}} = 19.8 \approx 20 \text{ k}\Omega$$

Let us also assume that the supply voltage varies by  $\pm 10 \%$ , i. e.  $\Delta V_S \approx 40 \text{ V}$ , the load current by  $\Delta I_L = 2 \text{ mA}$  and the ambient temperature by  $\Delta T_{amb} = 20 \text{ K}$ , then, according to equation (1), the output varies by

$$\begin{aligned} \Delta V_{out} &= \frac{125 \Omega \cdot 40 \text{ V}}{20 \text{ k}\Omega} + 125 \Omega \cdot 2 \text{ mA} + \\ &9 \cdot 10^{-4} / \text{K} \cdot 22 \text{ V} \cdot 20 \text{ K} \\ &= 250 \text{ mV} + 250 \text{ mV} + 396 \text{ mV} \end{aligned}$$

This example shows that ambient temperature variations exercise a larger effect on the output than supply voltage or load current variations.

Let us consider once more the example of the simple stabilizer circuit operating under low load current and high supply voltage conditions, discussed at the beginning of this section, but this time under the assumption that a temperature-compensated diode ZTK22 is used in place of the conventional ZPD22 device. Using equation (1) and inserting the same values for supply voltage, load current and ambient temperature variations into the expression, one obtains

$$\begin{aligned} \Delta V_{out} &= +\frac{-8.4 \Omega - 40 \text{ W}}{20 \text{ k}\Omega} + 8.4 \Omega \cdot 2 \text{ mA} + \\ &(-10 \cdot 10^{-5} / \text{K} \cdot 22 \text{ V} \cdot 20 \text{ K}) \\ &= -16.8 \text{ mV} - 16.8 \text{ mV} - 44 \text{ mV} \end{aligned}$$

The output voltage variation due to the specified change in temperature is only one tenth of that obtained in the previous mentioned example using

the conventional Zener diode ZPD22. Moreover it should be noted that the temperature coefficient used in the calculation ( $-10 \cdot 10^{-5}/K$ ) is the one guaranteed in the data, whereas the typical temperature coefficient of a ZTK device is normally  $-2 \cdot 10^{-5}/K$ .

Use of this value would reduce the temperature effect, as expressed in the third term of the equation, even further, namely to  $-8.8$  mV.

The conclusion is that in all applications where a simple stabilizer circuit is considered the use of ZTK temperature-compensated stabilizing circuits can bring a considerable improvement.



# Pulse Power Rating of Semiconductors

The admissible dissipation of diodes, rectifiers and Zener diodes which operate from sinusoidal supplies is based on the arithmetic mean value of junction temperature and power dissipation. Devices which handle pulses are capable of passing short-term currents far in excess of the maximum admissible static dissipation, and in this case it is admissible to exceed the continuous dissipation curve for the duration of each pulse.

The magnitude of the admissible current is then inversely proportional to the pulse duty factor, because power is dissipated only intermittently, and the thermal capacity of the system and heat conduction prevent an undue rise in junction temperature. Some of the data sheets contain diagrams which allow the rating of a device operating under pulsed conditions to be determined.

In Figure 1, which applies to diodes and rectifiers, the maximum admissible pulse current amplitude is plotted as a function of pulse duration for an ambient (or case) temperature of + 25 °C. If the device is to operate at higher ambient temperatures, then it is necessary to derate the current values derived from this diagram in accordance with the "admissible dissipation versus temperature" curve.

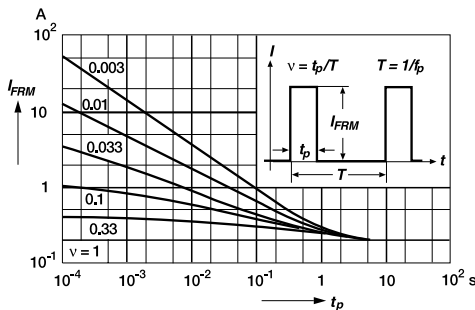

18610

Figure 1.

For Zener diodes it is preferable to provide a plot which gives the terminal pulse resistance rather than the admissible current amplitude as a function of tp (the duration of the rectangular pulse which causes power to be dissipated), as shown in Figure 2. The operational junction temperature can then be calculated by use of the formula

$$T_j = T_{amb} + P_I \cdot r_{thA}$$

or, if additional power PD is continuously dissipated, by use of the formula

$$T_j = T_{amb} + P_D \cdot R_{thA} + P_I \cdot r_{thA}$$

If the diode is fitted to a heat sink, then the equation becomes

$$T_j = T_{amb} + P_{tot} \cdot R_{thS} + P_I \cdot r_{thC}$$

where P<sub>tot</sub> is the mean value of P<sub>I</sub> (= pulse dissipation).

If additional power is continuously dissipated, then the above equation must be extended to

$$T_j = T_{amb} + P_{tot} \cdot R_{thS} + P_D \cdot R_{thC} + P_I \cdot r_{thC}$$

where P<sub>tot</sub> is the mean value of the total dissipated power.

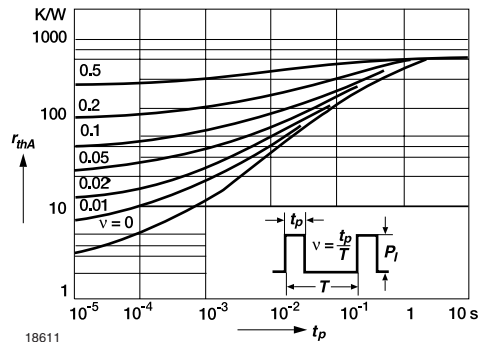

18611

Figure 2.

## Heat Removal from Semiconductor Components

The operation of any semiconductor device involves the dissipation of power with a consequent rise in junction temperature. Because the maximum admissible junction temperature must not be exceeded, careful circuit design with due regard not only to the electrical, but also the thermal performance of a semiconductor circuit is essential.

If the dissipated power is low, then sufficient heat is radiated from the surface of the case; if the dissipation

## Vishay Semiconductors

is high, however, additional steps may have to be taken to promote this process by reducing the thermal resistance between the junction and the ambient air. This can be achieved either by pushing a star- or flag-shaped heat dissipater over the case, or by bolting the semiconductor device to a heat sink.

$P$ , the power to be dissipated,  $T_j$  the junction temperature, and  $T_{amb}$ , the ambient temperature are related by the formula

$$P = \frac{T_j - T_{amb}}{R_{thA}} = \frac{T_j - T_{amb}}{R_{rtA} + R_{thS}}$$

where  $R_{thA}$  is the total thermal resistance between junction and ambient air. The total thermal resistance in turn comprises an internal thermal resistance  $R_{thC}$  between the junction and the mounting base, and an outer thermal resistance  $R_{thS}$  between the case and the surrounding air (or any other cooling medium). It should be noted that only the outer thermal resistance is affected by the design of the heat sink. To determine the size of the heat sink required to meet given operating conditions, proceed as follows: First calculate the outer thermal resistance by use of the formula

$$R_{thS} < \frac{T_j - T_{amb}}{P} = R_{thC}$$

and then, by the use of the following diagrams, determine the size of the heat sink which provides the calculated  $R_{thS}$ -value. To determine the maximum admissible device dissipation and ambient temperature limit for a given heat sink, proceed in the reverse order to that described above.

The calculations are based on the following assumptions: Use of a square shaped heat sink without any finish, mounted in a vertical position; semiconductor device located in the centre of the sink; heat sink operated in still air and not subjected to any additional heat radiation. The calculated area should be increased by a factor of 1.3 if the sink is mounted horizontally, and can be reduced by a factor of approximately 0.7 if a black finish is used.

The following curves give the thermal to ambient resistance of square vertical heat sinks as a function of side length. It is assumed that the heat is applied at the centre of the square.

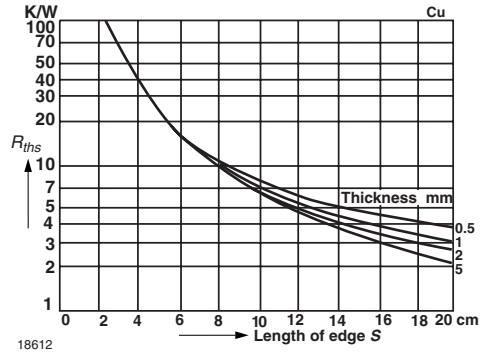

Figure 3. Copper Cooling Fin

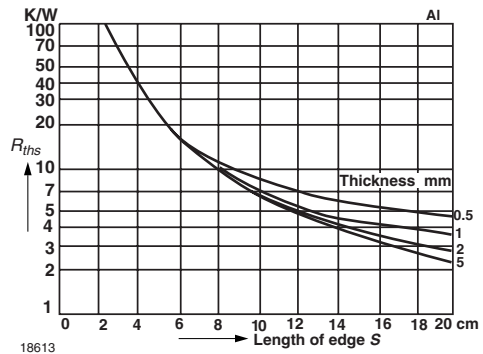

Figure 4. Aluminum Cooling Fin

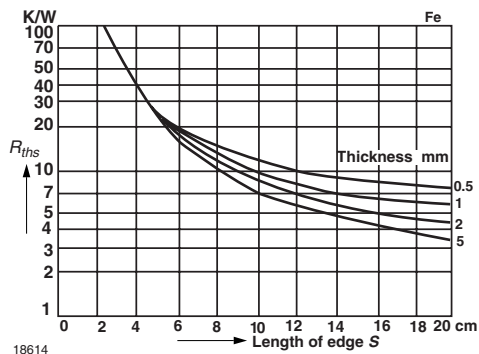

Figure 5. Steel Cooling Fin

**Selector Guides**



**General Information**



**Zener Datasheets**



**ESD Datasheets**



**Packages**

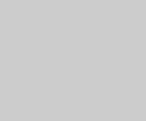

**Application Notes**

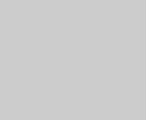

**Glossary**







# Symbols

## Arrangement of Symbols

### Letter symbols for current, voltage and power

(according to DIN 41 785, sheet 1)

To represent current, voltage and power, a system of basic letter symbols are used. Capital letters are used for the representation of peak, mean, dc or root-mean-square values. Lower case letters are used for the representation of instantaneous values which vary with time.

Capital letters are used as subscripts to represent continuous or total values, while lower case letters are used to represent varying values.

The following table summarizes the rules given above.

Basic letter	
Upper-case	Upper-case
Instantaneous values which vary with time	Maximum (peak) average (mean) continuous (dc) or root-mean-square (RMS) values

Subscript(s)	
Upper-case	Upper-case
Varying component alone, i.e., instantaneous, root-mean-square, maximum or average values	Continuous (without signal) or total (instantaneous, average or maximum) values

### Letter symbols for impedance, admittances, two-port parameters etc.

For impedance, admittance, two-port parameters, etc., capital letters are used for the representation of external circuits of which the device is only a part.

Lower case letters are used for the representation of electrical parameters inherent in the device.

The rules are not valid for inductance and capacitance. Both these quantities are denoted with capital letters.

Capital letters are used as subscripts for the designation of static (dc) values, while lower case letters are used for the designation of small-signal values.

If more than one subscript is used ( $h_{FE}$ ,  $h_{fe}$ ), the letter symbols are either all capital or all lower case.

If the subscript has numeric (single, double, etc.) as well as letter symbol(s) (such as  $h_{21E}$  or  $h_{21e}$ ), the differentiation between static and small-signal value is made only by a subscript letter symbol.

Other quantities (values) which deviate from the above rules are given in the list of letter symbols.

The following table summarizes the rules given above.

Basic letter	
Upper-case	Upper-case
Electrical parameters inherent in the semiconductor devices except inductances and capacitances	Electrical parameters of external circuits and of circuits in which the semiconductor device forms only a part; all inductances and capacitances

Subscript(s)	
Upper-case	Upper-case
Small-signal values	Static (dc) values

Examples:

- $R_G$  Generator resistance
- $G_P$  Power gain
- $h_{FE}$  DC forward current transfer ratio in common emitter configuration
- $r_P$  Parallel resistance, damping resistance

### Example for the use of Symbols

according to 41785 and IEC 148

b) Diode

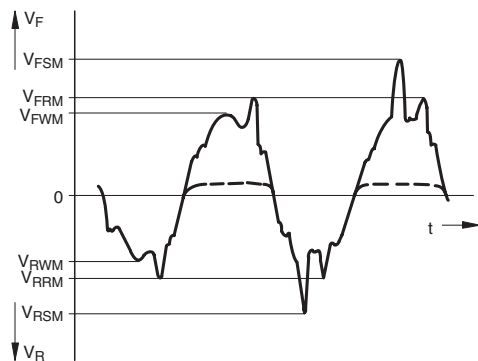

Figure 1.

- $V_F$  Forward voltage
- $V_R$  Reverse voltage
- $V_{FSM}$  Surge forward voltage (non-repetitive)
- $V_{RSM}$  Surge reverse voltage (non-repetitive)
- $V_{FRM}$  Repetitive peak forward voltage
- $V_{RRM}$  Repetitive peak reverse voltage
- $V_{FWM}$  Crest working forward voltage
- $V_{RWM}$  Crest working reverse voltage

**List of Symbols**

A	Anode	$r_s$	Series resistance
a	Distance (in mm)	$R_{thJA}$	Thermal resistance between junction and ambient
C	Capacitance, general	$R_{thJC}$	Thermal resistance between junction and case
$C_{case}$	Case capacitance	$r_z$	Differential Z-resistance in breakdown region (range) $r_z = r_{zj} + r_{zth}$
$C_D$	Diode capacitance	$r_{zj}$	Z-resistance at constant junction temperature, inherent Z-resistance
$C_i$	Junction capacitance	$r_{zth}$	Thermal part of the Z-resistance
$C_L$	Load capacitance	T	Temperature, measured in centigrade
$C_P$	Parallel capacitance	T	Absolute temperature, Kelvin temperature
F	Noise figure	T	Period duration
f	Frequency	T <sub>amb</sub>	Ambient temperature (range)
$f_g$	Cut-off-frequency	T <sub>case</sub>	Case temperature
$I_F$	Forward current	$t_{fr}$	Forward recovery time
$i_F$	Forward current, instantaneous total value	$T_j$	Junction temperature
$I_{FAV}$	Average forward current, rectified current	$T_K$	Temperature coefficient
$I_{FRM}$	Repetitive peak forward current	$T_L$	Connecting lead temperature in the holder (soldering point) at the distance/(mm) from case
$I_{FSM}$	Surge forward current, non-repetitive	$t_p$	Pulse duration (time)
$I_{FWM}$	Crest working forward current	$t_p/T$	Duty cycle
$I_R$	Reverse current	$t_r$	Rise time
$i_R$	Reverse current, instantaneous total value	$t_{rr}$	Reverse recovery time
$I_{RAV}$	Average reverse current	$t_s$	Storage time
$I_{RRM}$	Repetitive peak reverse current	$T_{sd}$	Soldering temperature
$I_{RSM}$	Non-repetitive peak reverse current	$T_{stg}$	Storage temperature (range)
$I_{RWM}$	Crest working reverse current	$V_{(BR)}$	Breakdown voltage
$I_S$	Supply current	$V_F$	Forward voltage
$I_Z$	Z-operating current	$V_F$	Forward voltage, instantaneous total value
$I_{ZM}$	Z-maximum current	$V_{FAV}$	Average forward voltage
l	Length (in mm), (case-holder/soldering point)	$V_o$	Rectified voltage
LOCEP	(local epitaxy)	$V_{FSM}$	Surge forward voltage, non-repetitive
A registered trade mark of Vishay for a process of epitaxial deposition on silicon. Applications occur in planer Z-diodes. It has an advantage compared to the normal process, with reduced reverse current.			
P	Power	$V_{FRM}$	Repetitive peak forward voltage
$P_{tot}$	Total power dissipation	$V_{FWM}$	Crest working forward voltage
$P_V$	Power dissipation, general	$V_R$	Reverse voltage
$P_{vp}$	Pulse-power dissipation	$V_R$	Reverse voltage, instantaneous total value
Q	Quality	$V_{RSM}$	Surge reverse voltage, non-repetitive
$Q_{rr}$	Reverse recovery charge	$V_{RRM}$	Repetitive peak reverse voltage
$R_F$	Forward resistance	$V_{RWM}$	Crest working reverse voltage
$r_f$	Differential forward resistance	$V_Z$	Z-operating voltage
$R_L$	Load resistor	$Z_{thp}$	Thermal resistance – pulse operation
$r_p$	Parallel resistance, damping resistance	$\eta_r$	Rectification efficiency
$R_R$	Reverse resistance	$\Delta C_D$	Capacitance deviation
$r_r$	Differential reverse resistance		

# WORLDWIDE SALES CONTACTS

## DISCRETE SEMICONDUCTORS AND PASSIVE COMPONENTS

### THE AMERICAS

#### VISHAY AMERICAS

ONE GREENWICH PLACE  
SHELTON, CT 06484  
UNITED STATES  
PH: +1-402-563-6866  
FAX: +1-402-563-6296

### ASIA

#### VISHAY INTERTECHNOLOGY ASIA PTE LTD.

25 TAMPINES STREET 92  
KEPPEL BUILDING #02-00  
SINGAPORE 528877  
PH: +65-6788-6668  
FAX: +65-6788-0988

### JAPAN

#### VISHAY JAPAN CO., LTD.

GE EDISON BUILDING, SHIBUYA 3F  
3-5-16 SHIBUYA  
SHIBUYA-KU  
TOKYO 150-0002  
JAPAN  
PH: +81-3-5464-6411  
FAX: +81-3-5464-6433

### EUROPE

#### VISHAY ELECTRONIC GMBH

GEHEIMRAT-ROSENTHAL-STR. 100  
95100 SELB  
GERMANY  
PH: +49-9287-71-0  
FAX: +49-9287-70435

#### VISHAY S.A.

4, RUE DE SALONIQUE  
95101 ARGENTEUIL  
FRANCE  
PH: +33-1-39-98-22-00  
FAX: +33-1-39-98-22-05

#### VISHAY LTD.

PALLION INDUSTRIAL ESTATE  
SUNDERLAND, SR4 6SU  
GREAT BRITAIN  
PH: +44-191-514-4155  
FAX: +44-191-567-8262

### ONLINE INFORMATION

For product information and a current list of sales offices,  
representatives and distributors, visit our website:

[www.vishay.com](http://www.vishay.com)

ONE OF THE WORLD'S LARGEST MANUFACTURERS OF DISCRETE SEMICONDUCTORS AND PASSIVE COMPONENTS



VISHAY INTERTECHNOLOGY, INC.

**World Headquarters**

63 Lincoln Highway  
Malvern, PA 19355-2143  
United States

**[www.vishay.com](http://www.vishay.com)**

---

© Copyright Vishay Intertechnology, Inc.  
® Registered Trademarks of Vishay Intertechnology, Inc.  
All rights reserved. Printed in Germany.  
Specifications subject to change without notice.

Databook Zener Diodes and ESD Protection Components  
VHN-DB1103-0406